



METRIE EL & EL
ECLISSE FLUSH SWING DOOR & POCKET SYSTEMS



ECLISSE — SYNTESIS® FLUSH COLLECTION

PRODUCT RANGE

A CONCEALED HINGED DOOR FRAME

This solution provides a flush wall door design (seen below) for clean lines where the frame disappears into the wall. Doors can be painted or stained as required.



ECLISSE
SYNTESIS SWING SINGLE



ECLISSE
SYNTESIS SWING DOUBLE

ECLISSE — SYNTESIS® FLUSH COLLECTION

SWING SINGLE



LONG LASTING AND PAINTABLE

The aluminum frame has undergone anodization treatment against oxidation and then it is primer-coated to facilitate paint adhesion. The frame is designed to avoid drywall from cracking around the door.

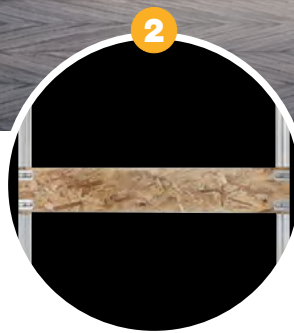

SPACER PANELS IN OSB 3

1" thick and pre-assembled to guarantee a perfect squaring of the frame.



THE HINGES

3 concealed adjustable hinges (height, width, depth) for a perfect calibration of the perimeter size.

Note: When the door weighs more than 100 lbs. (max 143 lbs.) and the door is greater than 96" or wider than 36", 4 hinges are required.

Standard Sizes Available In-Stock

ITEM	Door Width	Door Height
SWING SINGLE	24" – 36"	80" / 84" / 90" / 96" / 108" / 120"

Dimensions are given in inches.



ECLISSE — SYNTESIS® FLUSH COLLECTION

SWING SINGLE - DOUBLE

ECLISSE SYNTESIS SWING

It is possible to install the door flush with the ceiling thanks to the option with no header. This solution is available by special order.

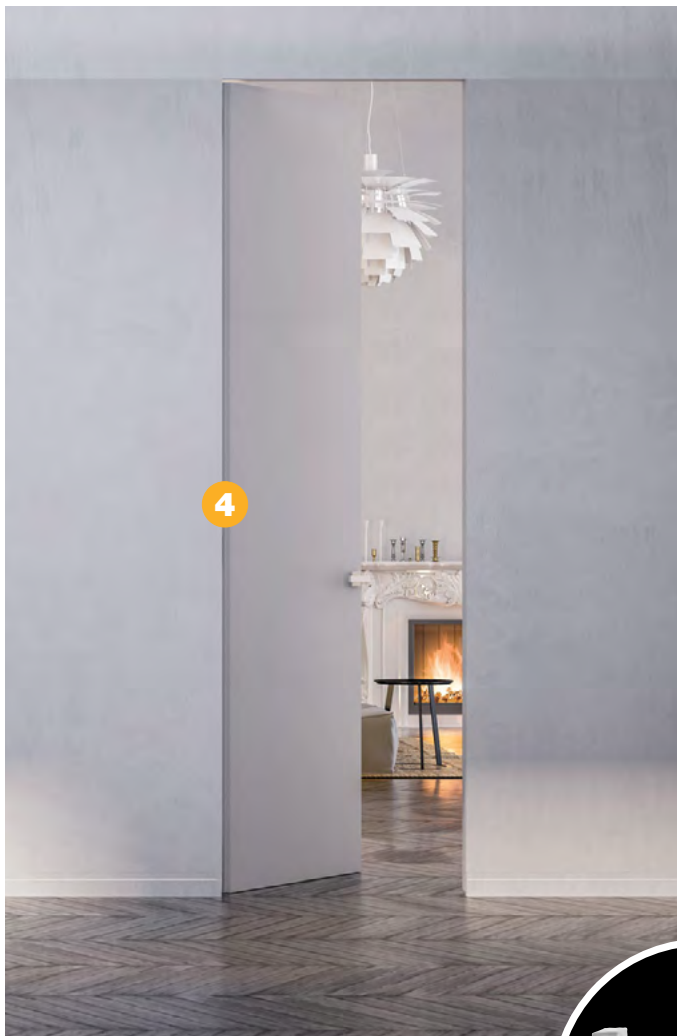

ECLISSE SYNTESIS SWING DOUBLE

Double door version available only with header.

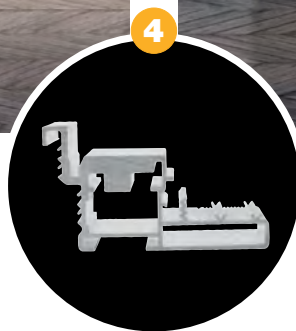

VERY STRONG FRAME

The frame profile weighs about 1.35 lbs/ft

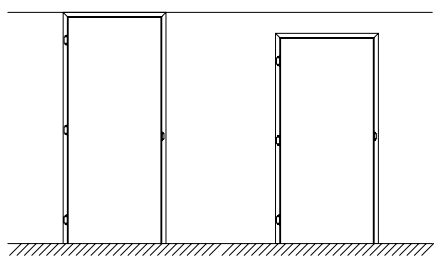

With Header

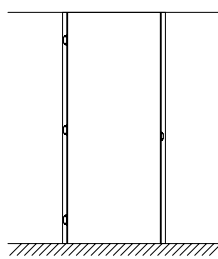

Without Header

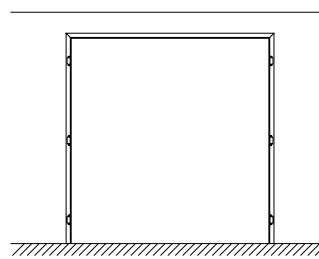

With Header Only

ECLISSE — SYNTESIS® FLUSH COLLECTION ACCESSORIES

Innovating means developing more targeted solutions and giving customers exactly what it takes to make daily life more comfortable. ECLISSE has designed and patented a series of automations and various accessories that make each pocket door system unique.



SYNTESIS SWING

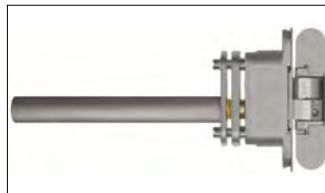
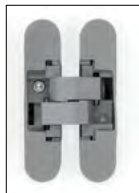

HARDWARE FOR SYNTESIS SWING

It includes lock kit (both Passage and Privacy), gaskets, hinges, and strike plate in Aluminum Chrome, White, Champagne, Bronze, or Black.

SELF-CLOSING DOOR HINGE

This hinge is a soft-closing mechanism that gently closes flush-to-the-wall wooden hinged doors.

Note: When the door weighs more than 100 lbs. (max 143 lbs.) and the door is greater than 96" or wider than 36", 4 hinges are required.



ECLISSE POCKET DOOR SYSTEMS

PRODUCT RANGE

THE ECLISSE CLASSIC COLLECTION

Requires jambs and is designed to be finished off with casing.

CLASSIC



ECLISSE **CLASSIC SINGLE**
For 2x4 or 2x6 Walls



ECLISSE **CLASSIC DOUBLE**
For 2x4 or 2x6 Walls

SYNTESIS

THE ECLISSE SYNTESIS COLLECTION

Provides a clean, modern aesthetic without jambs and architraves.

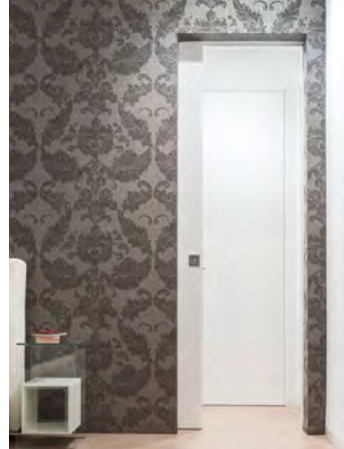

ECLISSE **SYNTESIS SINGLE**
For 2x4 or 2x6 Walls



ECLISSE **SYNTESIS DOUBLE**
For 2x4 or 2x6 Walls

LUCE CLASSIC



ECLISSE **CLASSIC LUCE SINGLE**
For 2x6 Walls Only



ECLISSE **CLASSIC LUCE DOUBLE**
For 2x6 Walls Only

LUCE SYNTESIS



ECLISSE **SYNTESIS LUCE SINGLE**
For 2x6 Walls Only



ECLISSE **SYNTESIS LUCE DOUBLE**
For 2x6 Walls Only

ECLISSE TELESCOPIC CLASSIC



ECLISSE **TELESCOPIC SINGLE**
Sliding pocket door system for two parallel doors disappearing into the same pocket.



ECLISSE **TELESCOPIC DOUBLE**
Sliding pocket door system for two sets of parallel doors disappearing into the same pocket.

CLASSIC COLLECTION AUTOMATIONS & ACCESSORIES

Innovating means developing more targeted solutions and giving customers exactly what it takes to make daily life more comfortable. ECLISSE has designed and patented a series of automations and various accessories that make each pocket door system unique.



ECLISSE BIAS®

Soft close with anti-slam technology for single and double doors.

This soft closer is fully integrated inside the track and invisible from the outside, gently slows down the door in the closing phase with a smooth quiet motion.



ECLISSE BIAS® DS

Bidirectional soft close with anti-slam technology for single and double doors.

This bidirectional soft closer is fully integrated inside the track and invisible from the outside, gently slows down the door in both the opening and closing phase providing a smooth quiet motion in both directions.



SELF-CLOSING SYSTEM

The Self Closing system is manually operated and once opened the door closes automatically.

This mechanism allows you to have a hold open feature and with the simple touch, the door will close by itself. The door closing speed can be adjusted at any time without removing the door.



DOUBLE DOOR COORDINATION

This device allows you to open and close the two door simultaneously by moving only one panel. The Double Door Coordination Kit is to be used in conjunction with the ECLISSE BIAS (Soft Closer) allowing for the doors to close softly and quietly.

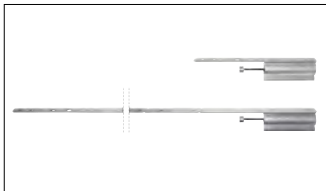

ECLISSE ANTI-SLAM, HEAVY DUTY, ADA-COMPLIANT SOFT CLOSER

ECLISSE Anti Slam- Heavy Duty is a soft closer fully integrated inside the track and invisible from the outside. The Anti Slam HD is a mechanism equipped with an oil piston which slows down the door and in both the closing and opening phase (need qty x2 for both functions).

Meets ADA requirements
(less than 5lbs of force to operate)

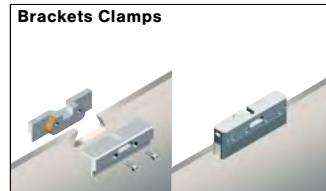

BRACKETS/ CLAMPS FOR FRAMELESS GLASS DOORS

The ECLISSE frame kit allows you to use any door you want including frameless glass on the same system. To use frameless glass, you will need either the brackets or compression clamps to be able to install your glass door.

For use with ECLISSE CLASSIC or ECLISSE SYNTESIS.



VITRO - ADAPTER FOR SYNTESIS GLASS DOORS

Vitro is a glass door adapter for models of the ECLISSE SYNTESIS COLLECTION that can also be used with doors not supplied by ECLISSE.



TELESCOPIC SYNCHRONIZATION

A device that ensures a simultaneous and smooth movement of the door panels which slide into the same direction.

It can be applied on:
ECLISSE TELESCOPIC SINGLE and DOUBLE



ECLISSE POCKET DOOR SYSTEMS

SINGLE - DOUBLE 2x4

ECLISSE has found a way to re-invent the pocket door and checked every box when it comes to eliminating all of the problems associated with pocket doors. We offer a complete pocket door system - utilizing a galvanized steel frame kit with patented removable track so you never have to break drywall again, making potential future maintenance far less costly and quicker task.

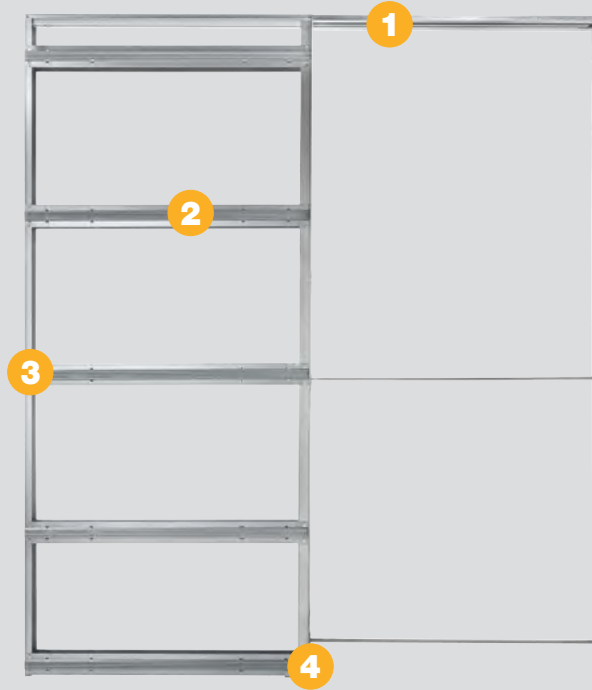

Standard Sizes Available In-Stock

ITEM	Door Width	Door Height
Kits 2x4	24" – 48"	80" / 84" / 90" / 96" / 108" / 120"

Dimensions are given in inches

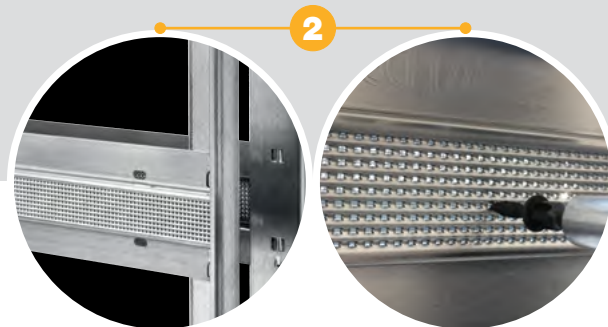
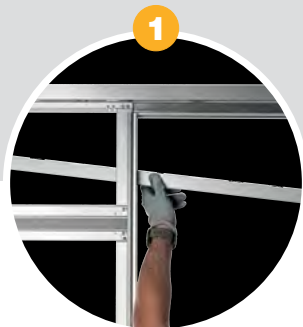

EXTRACTABLE RUNNING TRACK

The whole running track mechanism can be removed without breaking into the wall.

PRE-DRILLED HORIZONTAL BARS – U.S. PATENT NO. 11.499.309

Quicker application of the drywall. In the ongoing effort to ease the construction work for the installer, ECLISSE introduced a perforated weave obtained by pre-drilling the horizontal reinforced bars. The new micro drill-holes allows the screw to enter more easily into the metal sheet, speeding up the installer's work in the application of the drywall.



ECLISSE POCKET DOOR SYSTEMS

SINGLE - DOUBLE 2x6

The first pocket door system which allows you not only to arrive up to 72". Our Luce Kit add-on for 2x6 Frame Kits allows wiring installation of shallow electrical boxes used in thermostats, outlets, etc into the same wall as the pocket frame. You can have up to 2 Luce Kits per Single frame kit and 4 on Doubles (1 on each side of the frame). The Luce Kit, will make full use of the wall where your pocket door is installed, opening up a whole host of options for interior lighting plans and other functional & aesthetic design ideas.

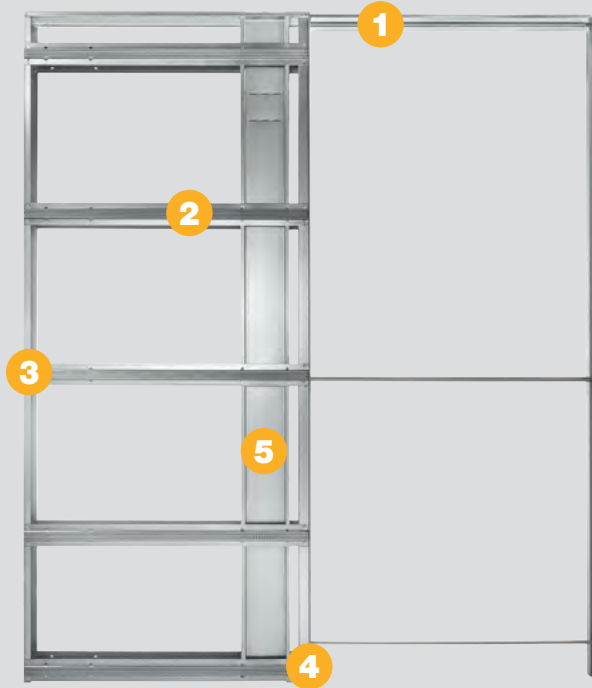

Standard Sizes Available In-Stock

ITEM	Door Width	Door Height
Kits 2x6	24" – 48"/60"/66"/72"	80" / 84" / 90" / 96" / 108" / 120"

Dimensions are given in inches



EASY ASSEMBLY

The frame has been purposely designed to be assembled very quickly and simply with just a screwdriver.

The kit packaging makes transportation quicker and easier to spread on a job site.

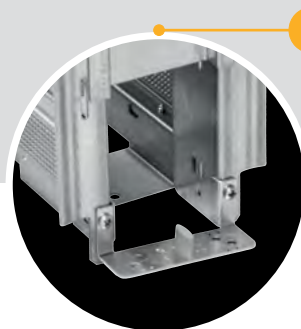

CLASSIC

DOOR GUIDE

Quick and easy to fit to the frame with no holes to drill into finished flooring, this guide cleverly guarantees a perfectly centered position.



SYNTESIS

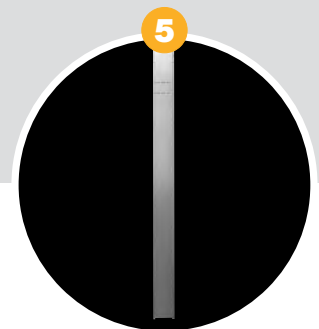

LUCE KIT

It is not included with the frame kit and sold separately - only compatible with 2x6 wall frame kits.



ECLISSE POCKET DOOR SYSTEMS

ACCESSORIES

CLASSIC COLLECTION **ADDITIONAL ACCESSORIES**

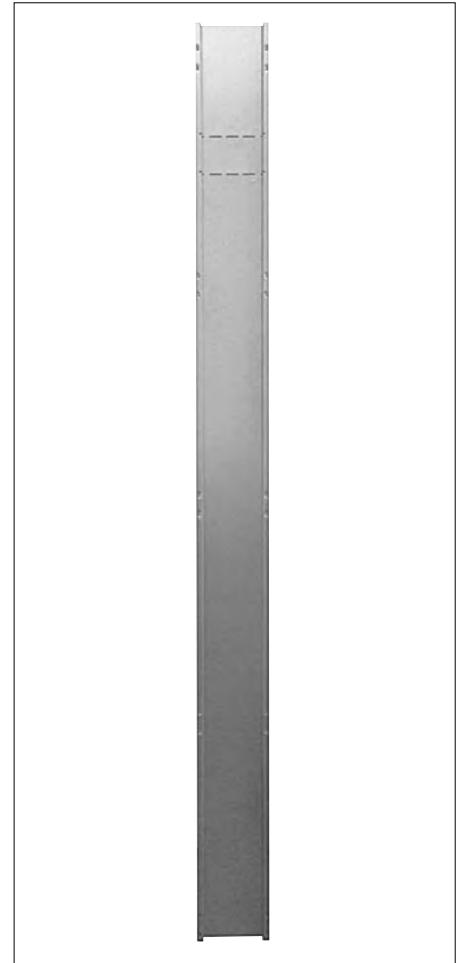
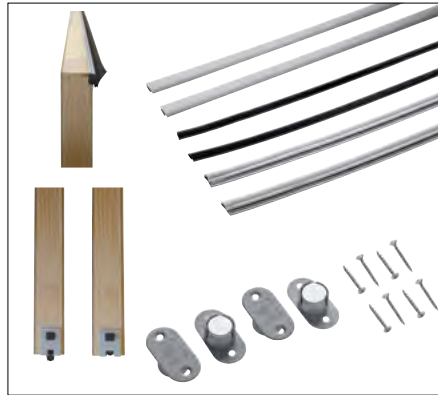

ACOUSTIC KIT

Magnets, Bumpers, Gaskets and Upper/Bottom Weatherstrip for sound insulation, tested to 38 decibels.

ECLISSE ACOUSTIC is an integrated system with high soundproof performance designed to reduce the noise between rooms providing all of the advantaged of a pocket door along with the acoustic comfort.



JAMB KITS

The jamb kit attaches to the pocket door framework that cover the edges of the door when it is closed so you cannot see the top of the door or into the pocket.

These kits comes complete with; gaskets & dust brushes.

Available in both Primed or Stain Grade, as well as, available for all Classic Collection Systems.

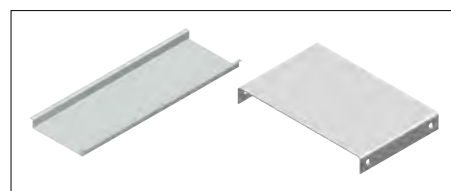

UNILATERAL KIT

ECLISSE UNILATERAL frame allows two opposite doors to slide into the same pocket. It requires only a single frame's overall dimension, but it hosts two parallel doors going in opposite directions.



LUCE KIT

Allows you to install wiring for shallow electrical boxes used in thermostats, outlets, etc into the same wall where the frame is placed.

With the Luce Kit, you will be able to make full use of the wall where your pocket door is installed.

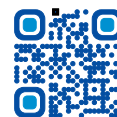

A GREAT WARRANTY

The ECLISSE steel pocket door system is guaranteed for 12 years.



METRIE EL & EL

Moulding | Doors | Commercial | Jamb & Frames

Moulding & More

Ultralight MDF Mouldings & Boards

Domestic LDF Mouldings, Boards & T&G

Solid & Primed FJ Pine Mouldings

Redwood & VG Fir Mouldings

Hardwood Mouldings

(Cherry, Maple, Mahogany, Superior & Knotty Alder, Poplar, Oak, Walnut)

ValuFlex® Flexible Moulding

(Manufactured at EL & EL)

Bodyguard® Protected Exterior Trimboard & Siding

MiraTEC® & Extira® Treated Exterior Composite Trim & Shutter Board

Interior & Exterior Door Jamb & Frames

(Primed FJ & Solid Pine, Poplar, Engineered FG & VG Fir, Oak, Cherry, Alder, Mahogany, Composite)

Weatherstrip, Flashing & Shims

Columns & Accessories

HB&G® Columns & Porch Systems

Fypon® Polyurethane Beams & Accessories
(Raw & Prefinished)

Accessories

(Plinth Blocks, Rosettes, Base Corners)

Majestic Mantels® (Assembled at EL & EL)

Pre-built Shelves, Surrounds & Pilaster Kits

Built-Up Pocket Door Frames

(Assembled at EL & EL)

Boxed Pocket Door Frames

(coxUSA & Johnson Hardware)

Eclipse® Steel Pocket Door Systems

(Boxed)

Closet Material

(Shelving, Brackets, Poles, Edge Banding)

Doors – Interior & Exterior

(Pre-hanging Available)

Knotty Alder Doors

Masonite® Clear & Knotty Pine Doors

Primed MDF, Clear Pine Louver Doors & Bifolds

Masonite® Solid Core Hardboard Doors

Masonite® Moulded Panel Doors & Bifolds

Masonite® Fiberglass & Steel Exterior Doors

(Pre-hanging & Pre-finishing available)

Simpson® Interior & Exterior Doors

Shaker Doors & Bifolds (Primed, VG Fir & Alder)

Trimlite® Decorative Glass

Barn Doors

(Knotty Alder, Knotty Pine & Primed MDF)

Barn Door Hardware

(Rustic & Stainless Steel)

CoxUSA® Hardware Components

Commercial & Architectural Doors

RediFrame® & RediFlex® Steel Frames

Hollow Metal Doors & Frames

Lites & Louvers

ARAUCO

ValuFlex®

ECLIPSE®
SLIDING POCKET DOOR SYSTEMS

MIRATEC®

MASONITE®
ARCHITECTURAL

REDIFRAME®

TRIMLITE®

MAJESTIC®
Mantels

HB&G

FYPON

BODYGUARD®
real wood made better

MASONITE®
DOORS

Simpson®
Door Company

COXUSA

MASISA

Lynden Door

UNPARALLELED SERVICE

NEXT DAY DELIVERY

INNOVATIVE SELECTION

EASY ORDERING



METRIE

EL & EL Wood Products

