



EL & EL Wood Products
HALF A CENTURY OF SERVICE



details

EL&EL MOULDING COLLECTION

MDF HARDWOODS PINE REDWOOD FIR ACCESSORIES DOORS

Character, built in.™

DISTRIBUTED BY



CONVENIENT TABBED DIVIDERS
Fold out for fast access to the sections you use most.



Accessories add to the architectural sophistication of any room, as well as to your individual sense of style. With so many custom choices you can shape and mold to fit any architectural challenge. Get creative with ValuFlex™ flexible mouldings that match and mimic the grain of your chosen specie. Rosettes and plinth blocks add unforgettable detail and dimension, greater than the casing and base alone.

section contents

| | |
|---|----|
| Base Plinth Blocks | 6 |
| Dowels / Dowel Pins | 8 |
| Finishing Instructions..... | 14 |
| Flexible Mouldings..... | 2 |
| Majestic Mantels..... | 9 |
| Plugs | 8 |
| Radius Base Corners..... | 4 |
| Rosette Plinth Blocks..... | 5 |
| Screwhole Plugs | 8 |
| Simple Solutions™ Flush Crown Corners ... | 4 |



Accessories

THE LITTLE THINGS MAKE THE DIFFERENCE



MAJESTIC
Mantels

Accessories help to create a more sophisticated, individual look for your home or office. Accessories offer custom choices to shape and mold any architectural need.

Simple Solutions™, a flush miterless crown corner system, provides hassle-free installation, architectural enhancement and can be used with radiused drywall or square corners.

Radius Bullnose Base Corners match the baseboard profiles being installed and continue the radius look of rounded drywall corners. With time and attention to detail, base corners soften and enhance the entire look of any home and are available in most base profiles and species.

Flexible Mouldings are manufactured on our premises and offer a perfect match to our moulding profiles. ValuFlex™ is used for any radius or curve of a wall, window or decorative element. When painted or stained, flexible moulding has the beauty, look and feel of real wood and costs less than radiused wood millwork.

Rosettes and Base Plinth Blocks are considered traditional, yet add a beautiful architectural element. No mitering and easy installation make them a favorable choice for adding detail. When choosing a baseboard that is thicker than your casing, simply put a thicker block at the bottom of your casing that is 1/4" or greater in thickness and in height than the baseboard.

EL & EL is proud to introduce a new line of mantels and mantel surrounds. From simple to upscale, choose a mantel that will enhance the look of your existing fireplace or perfectly complete a new project. Majestic Mantels™ are affordable and easy to install. Add unique character to any room in your home with mantel shelves.

architectural enhancement

sharp details

faux finish, stain, or paint



(items are approximate scale only)

Flexible Mouldings

1

easy to order



Your order will arrive
in 2-3 days.

2

easy to match



Your pattern will be
matched exactly.

3

easy to love



Your satisfaction is
100% guaranteed.

ValuFlex™



EL & EL Wood Products manufactures on its premises, ValuFlex™ Flexible Mouldings—the highest quality urethane available in today's market.

easy to match ANY PROFILE

Whether you're adding trim to arched windows or curved walls, it's **easy** to match any moulding profile with **ValuFlex™** from EL & EL.

This innovative material handles and finishes like real wood and is engineered to resist cracking, warping, splitting and mildewing. Extreme flexibility, less shrinkage and more detail make ValuFlex™ the right choice when a perfect match is a must.

- ✓ Superior lead-time
- ✓ Match any profile
- ✓ Incredible detail
- ✓ Paints or stains beautifully
- ✓ Tear resistant
- ✓ Minimal shrinkage
- ✓ Limited 5-year warranty
- ✓ Custom profiles available
- ✓ Manufactured on our premises

base | casing | crown | chair rail | jambs | built-ups

flexible mouldings | accessories



ValuFlex™ When a perfect match is a must!

All the advantages of radiused wood at a fraction of the cost.



“Yes, you can stain it!”

easy to order

Use part number of desired pattern, the species and add an “F” for ValuFlex™.

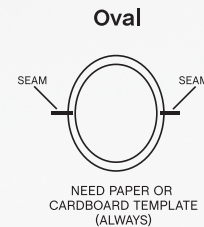
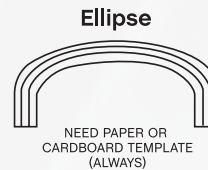
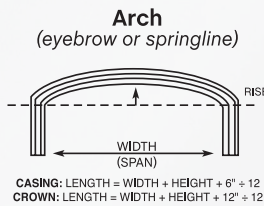
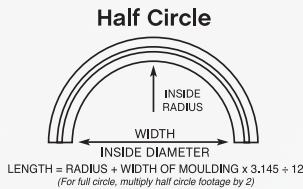

Casing

- On true half-circles, order by radius (equals 1/2 of diameter) or by diameter. (Please state “radius” or “diameter” when ordering.)
- When ordering arches, please state “span and rise” (ie: 21” span x 6” rise)
- Ellipses always require a template.

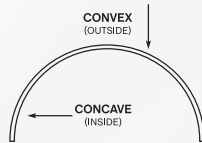

Crown

- Does the wall curve inside (concave) or outside (convex)?
- Radius of wall - IR (inside radius), OR (outside radius).
- Length of moulding needed (add for waste) to cover entire area.
- How many pieces?

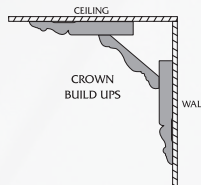

Crown Build Ups

- Order as IR (Concave) or OR (Convex) radius.
- Any moulding used on the wall: order as straight.
- Any moulding used on the ceiling: order as a radius.
 - On an OR (outside radius), you must add the projection of the crown to the ceiling moulding radius. Example: If using the 330MUL on a ceiling with the 410MUL crown which has a projection of 4-1/2” and the wall is a 60” radius, 330MUL should be ordered as a 64-1/2” radius.
 - On an IR (inside radius), you must subtract the projection of the crown from the radius, therefore a wall with a 60” radius less the 4-1/2” projection = 55-1/2” IR for the 330MUL.

Base

- If Base is being used as Baseboard or as part of a Crown detail on a wall, the Flex Base does not need to be pre-cast to any radius. They are sold as straights and only total lineal footage is needed.
- If Baseboards are used as Casing the base must be ordered to the radius (like section I). If base is being used as part of a Crown detail where they lay flat on the ceiling (not on the wall), then information as indicated in section III C1 or C2 must be provided.

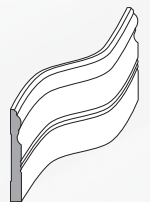

Panel Moulds/Lineal Moulds/Chair Rail

- If used horizontally on curved walls, straight lengths will work.

Backbands

- Radius on main casing that backband is to attach to.
- Type of curve (arch, ellipse, half-circle and information under Casings)
- Moulding part numbers, species, length, and count.

HINT: HOW TO FIGURE A RADIUS

Concave - IR Inside Application

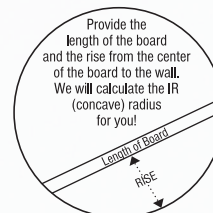

Convex - OR Outside Application

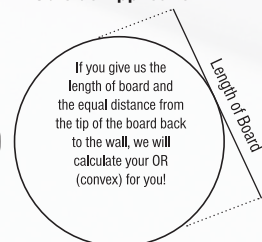

Flex, manufactured by EL & EL, assures a perfect match to any of our moulding profiles.

General Information

ValuFlex™ is a urethane resin and can be used for most interior or exterior profiles.



TO PAINT

- 1) Fill and sand, like wood, using a filler that will adhere to an oil based man-made product.
- 2) If using water based Latex paint, proceed as you would with any paintable product. If you are using an oil based paint, apply 2 base coats of Latex Enamel (water based) paint as an underbody. Do not use primer as an underbody when using oil based paint. Use a water born enamel paint as a primer. This will ensure proper drying of the oil based paint by providing a seal between the urethane and the oil based paint.
- 3) Apply Latex Enamel or Oil Based Enamel, like the straight mouldings, and finish the same.



TO STAIN

- 1) Finish and sand, like wood, using a filler that matches stain color and will adhere to an oil based man-made product.
- 2) Apply a pre-packaged "Base Coat Latex Glazing Fluid." Many manufactures offer these specific finishes for this purpose. After applying, wipe gently with a clean cloth. Re-apply stain as many times as needed to develop depth of color.
- 3) After the glaze has been wiped to the desired appearance, it must be allowed to dry and then sealed with the same top coat being used on the wood.
- 4) We strongly recommend that first time users practice on a piece of scrap flex moulding before finishing the moulding being used on the job.

Simple Solutions™ Flush Crown Corners

(items are approximate scale only)

Simple Solutions™ is a new resin miterless crown corner solution to ease installation and create a great finished look. No mitering, no difficult angle configurations, no need for additional material (in case of mitering errors) and best of all, Simple Solutions™ crown corners will

enhance and add architectural beauty and interest to any home. Simple Solutions™ miterless crown corners are available for inside, outside and bullnosed corners. Simple Solutions™ crown corners are available for most Ultralite MDF (MUL) crown profiles only.



Radius Base Corners

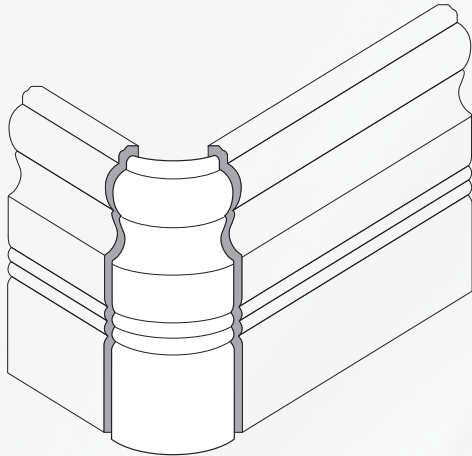

Straight mouldings fit flush to radius corner blocks making professional installation quick and easy.

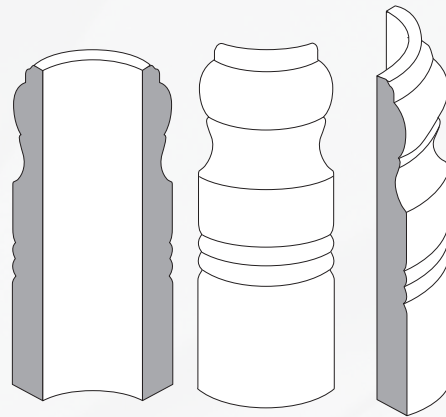

Bullnose Base Corners

Known as bullnose corners, quite popular today, many homes offer the look of eased rounded corners where drywall edges meet.

These rounded edges soften a home and enhance the entire look of the house. When the baseboard is installed, radius corners continue the eased corner look. A beautiful and elegant enhancement at very little cost.

Radius corners can be manufactured in any wood species.

All base profiles are available in radius corners for 3/4" drywall. Custom radius corners are available upon request.

(items are approximate scale only)

Rosette Plinth Blocks

NOW AVAILABLE IN: Poplar, Oak, MDF, Cherry, Maple & Alder



(PB3 shown)

Wellington Rosette w/Edge Detail



TIP
When ordering Rosettes, order 1/4" wider and thicker than the casing being used.

| DIMENSION | POPLAR (PAINTGRADE) | OAK (-O) | MDF (MDF) | CHERRY (C) | MAPLE (MP) | ALDER (ALD) |
|-------------|---------------------|-----------------|------------------|----------------|-----------------|------------------|
| 7/8 x 2-3/4 | PB1 | PB1-O | — | — | — | — |
| 7/8 x 3-1/2 | PB2 | PB2-O | — | — | — | — |
| 7/8 x 3-3/4 | PB3 | PB3-O | — | — | — | — |
| 7/8 x 5-3/4 | PB4 | PB4-O | — | — | — | — |
| 1 x 4 | ROS158 | ROS158-O | — | — | — | — |
| 1 x 3-3/4 | ROS160 | ROS160-O | ROS160MDF | ROS160C | ROS160MP | ROS160ALD |
| 1 x 2-3/4 | ROS162 | ROS162-O | ROS162MDF | ROS162C | ROS162MP | ROS162ALD |
| 1 x 4-1/2 | ROS164 | ROS164-O | ROS164MDF | ROS164C | ROS164MP | ROS164ALD |
| 1 x 5-1/2 | ROS165 | ROS165-O | ROS165MDF | ROS165C | ROS165MP | ROS165ALD |
| 1 x 3-1/2 | ROS169 | ROS169-O | ROS169MDF | ROS169C | ROS169MP | ROS169ALD |
| 3/4 x 2-1/2 | — | — | ROS170MDF | — | — | — |
| 3/4 x 3-1/4 | — | — | ROS171MDF | — | — | — |
| 3/4 x 3-1/2 | — | — | ROS172MDF | — | — | — |

Cambridge Rosette without Edge Detail



| DIMENSION | POPLAR (PAINTGRADE) | OAK (-O) | MDF (MDF) | CHERRY (C) | MAPLE (MP) | ALDER (ALD) |
|-------------|---------------------|---------------|----------------|--------------|---------------|----------------|
| 7/8 x 2-3/4 | PB6 | PB6-O | — | — | — | — |
| 7/8 x 3-1/2 | PB7 | PB7-O | — | — | — | — |
| 7/8 x 3-3/4 | PB8 | PB8-O | — | — | — | — |
| 5/8 x 2-1/2 | PB9 | PB9-O | — | — | — | — |
| 3/4 x 3-1/4 | PB10 | PB10-O | — | — | — | — |
| 3/4 x 3-1/2 | PB11 | PB11-O | — | — | — | — |
| 1 x 2-3/4 | PB20 | PB20-O | PB20MDF | PB20C | PB20MP | PB20ALD |
| 1 x 3-1/2 | PB21 | PB21-O | PB21MDF | PB21C | PB21MP | PB21ALD |
| 1 x 3-3/4 | PB22 | PB22-O | PB22MDF | PB22C | PB22MP | PB22ALD |
| 1 x 4-1/2 | PB23 | PB23-O | PB23MDF | PB23C | PB23MP | PB23ALD |
| 1 x 5-1/2 | PB24 | PB24-O | PB24MDF | PB24C | PB24MP | PB24ALD |



Architectural Rosette

| DIMENSION | POPLAR (PAINTGRADE) | OAK (-O) |
|-------------------|---------------------|-----------------|
| 1 x 3-3/4 x 5-3/4 | ROS166 | ROS166-O |
| 1 x 4-1/2 x 6-1/2 | ROS167 | ROS167-O |
| 1 x 5-1/2 x 7-1/2 | ROS168 | ROS168-O |

Base Plinth Blocks

(items are approximate scale only)

NOW AVAILABLE IN: Poplar, Oak, MDF, Cherry, Maple & Alder

① Base blocks should be 1/4"-1" wider than casing and 1/2"-2" taller than base.



Springfield Base Block w/Edge Detail

| DIMENSION | POPLAR (PAINTGRADE) | OAK (-O) | MDF (MDF) | CHERRY (C) | MAPLE (MP) | ALDER (ALD) | POPLAR (P) |
|------------------------|---------------------|---------------|----------------|--------------|---------------|----------------|--------------|
| 3/4 x 3-1/4 x 6-1/2" | — | — | 1BBMDF | — | — | — | — |
| 3/4 x 3-1/2 x 6-1/2" | — | — | 2BBMDF | — | — | — | — |
| 3/4 x 2-1/2 x 5-3/4" | — | 3BB-O | 3BBMDF | — | — | — | — |
| 1-1/4 x 3-1/4 x 6-1/2" | — | — | 4BBMDF | — | — | — | — |
| 1-1/4 x 3-1/2 x 6-1/2" | — | — | 5BBMDF | — | — | — | — |
| 7/8 x 2-3/4 x 6" | 6BB | 6BB-O | — | — | — | — | — |
| 7/8 x 3-1/2 x 6" | 7BB | 7BB-O | — | — | — | — | — |
| 7/8 x 3-3/4 x 6" | 8BB | 8BB-O | — | — | — | — | — |
| 1 x 5-3/4 x 8" | 9BB | 9BB-O | — | — | — | — | — |
| 1 x 2-3/4 x 6" | 35BB | — | 35BBMDF | 35BBC | 35BBMP | 35BBALD | 35BBP |
| 1 x 3-1/2 x 6" | 36BB | — | 36BBMDF | 36BBC | 36BBMP | 36BBALD | 36BBP |
| 1 x 3-3/4 x 6" | 37BB | — | 37BBMDF | 37BBC | 37BBMP | 37BBALD | 37BBP |
| 1 x 4-1/2 x 8" | 38BB | 38BB-O | 38BBMDF | 38BBC | 38BBMP | 38BBALD | 38BBP |
| 1 x 5-1/2 x 8" | 39BB | — | 39BBMDF | 39BBC | 39BBMP | 39BBALD | 39BBP |

TIP

When ordering Base Blocks, order at least 1/4" wider than the casing being used.

(Base Blocks should be thicker than the casing and base being used.)



Rosette Base Block without Edge Detail

| DIMENSION | POPLAR (PAINTGRADE) | OAK (-O) | MDF (MDF) | CHERRY (C) | MAPLE (MP) | ALDER (ALD) | POPLAR (P) |
|------------------|---------------------|---------------|----------------|--------------|---------------|----------------|--------------|
| 7/8 x 2-3/4 x 6" | 14BB | 14BB-O | — | — | — | — | — |
| 7/8 x 3-1/2 x 6" | 15BB | 15BB-O | — | — | — | — | — |
| 7/8 x 3-3/4 x 6" | 16BB | 16BB-O | — | — | — | — | — |
| 1 x 2-3/4 x 6" | 40BB | 40BB-O | 40BBMDF | 40BBC | 40BBMP | 40BBALD | 40BBP |
| 1 x 3-1/2 x 6" | 41BB | 41BB-O | 41BBMDF | 41BBC | 41BBMP | 41BBALD | 41BBP |
| 1 x 3-3/4 x 6" | 42BB | 42BB-O | 42BBMDF | 42BBC | 42BBMP | 42BBALD | 42BBP |
| 1 x 4-1/2 x 8" | 43BB | 43BB-O | 43BBMDF | 43BBC | 43BBMP | 43BBALD | 43BBP |
| 1 x 5-1/2 x 8" | 44BB | 44BB-O | 44BBMDF | 44BBC | 44BBMP | 44BBALD | 44BBP |



Fluted Rosette Base Block

| DIMENSION | POPLAR (PAINTGRADE) | OAK (-O) |
|------------------|---------------------|---------------|
| 7/8 x 3-3/4 x 7" | 18BB | 18BB-O |



Plain Springfield Base Block w/Edge Detail

| DIMENSION | POPLAR (P) | OAK (-O) | MDF (MDF) |
|----------------|-------------|---------------|----------------|
| 1 x 4-1/2 x 8" | 38BB | 38BB-O | 38BBMDF |



Colonial Base Block w/Rosette

| DIMENSION | POPLAR (PAINTGRADE) | OAK (-O) |
|----------------|---------------------|----------------|
| 1 x 4-1/2 x 8" | 185BB | 185BB-O |
| 1 x 5-1/2 x 8" | 186BB | 186BB-O |
| 1 x 3 x 5" | 192BB | 192BB-O |
| 1 x 4 x 7" | 193BB | 193BB-O |





(items are approximate scale only)

ⓘ Base blocks should be 1/4"-1" wider than casing and 1/2"-2" taller than base.

Base Plinth Blocks

NOW AVAILABLE IN: Poplar, Oak, MDF, Cherry, Maple & Alder

|  | Colonial Base Block | | | | | | |
|---|----------------------|---------------------|----------------|-----------|------------|------------|-------------|
| | DIMENSION | POPLAR (PAINTGRADE) | OAK (-O) | MDF (MDF) | CHERRY (C) | MAPLE (MP) | ALDER (ALD) |
| | 7/8 x 2-3/4 x 6" | 10BB | 10BB-0 | — | — | — | — |
| | 7/8 x 5-3/4 x 8" | 11BB | 11BB-0 | — | — | — | — |
| | 7/8 x 3-3/4 x 6" | 12BB | 12BB-0 | — | — | — | — |
| | 7/8 x 3-1/2 x 6" | 13BB | 13BB-0 | — | — | — | — |
| | 3/4 x 2-1/2 x 5-3/4" | 21BB | 21BB-0 | — | — | — | — |
| | 1 x 3-1/4 x 6-1/2" | 22BB | 22BB-0 | — | — | — | — |
| | 1 x 3-1/2 x 6-1/2" | 23BB | 23BB-0 | — | — | — | — |
| | 1 x 4-1/2 x 8" | 183BB | 183BB-0 | — | — | — | — |
| | 1 x 5-1/2 x 8" | 187BB | 187BB-0 | — | — | — | — |
| | 1 x 4 x 7" | 190BB | 190BB-0 | — | — | — | — |
| | 1 x 3 x 5" | 191BB | 191BB-0 | — | — | — | — |

|  | IEE Base / Craftsman Base Block | | | | | | |
|--|---------------------------------|------------------------|----------|-----------|------------|------------|----------------|
| | DIMENSION | POPLAR (PAINTGRADE) | OAK (-O) | MDF (MDF) | CHERRY (C) | MAPLE (MP) | ALDER (ALD) |
| | 1-1/4 x 4-1/4 x 6-3/4" | PR30BB (primed) | — | — | — | — | 30BBALD |

|  | Colonial Base Block | | | | | |
|---|---------------------|----------------|-----------------|----------------|-----------------|---------------------|
| | DIMENSION | OAK (-O) | MDF (MDF) | MAPLE (MP) | ALDER (ALD) | POPLAR (PAINTGRADE) |
| | 1 x 2-3/4 x 6" | 194BB-0 | 194BBMDF | 194BBMP | 194BBALD | 194BB |
| | 1 x 3-1/2 x 6" | 195BB-0 | 195BBMDF | 195BBMP | 195BBALD | 195BB |
| | 1 x 3-3/4 x 6" | 196BB-0 | 196BBMDF | 196BBMP | 196BBALD | 196BB |
| | 1 x 4-1/2 x 6" | 197BB-0 | 197BBMDF | 197BBMP | 197BBALD | 197BB |
| | 1 x 5-1/2 x 6" | 198BB-0 | 198BBMDF | 198BBMP | 198BBALD | 198BB |

|  | Inside / Outside Colonial Base Corner | | | | | | |
|---|---------------------------------------|---------------------|--------------|-----------|------------|------------|-------------|
| | DIMENSION | POPLAR (PAINTGRADE) | OAK (-O) | MDF (MDF) | CHERRY (C) | MAPLE (MP) | ALDER (ALD) |
| | 7/8 x 6-3/4 (inside) | IBC | IBC-0 | — | — | — | — |
| | 1-1/8 x 6-3/4 (outside) | OBC | OBC-0 | — | — | — | — |



Dowels / Dowel Pins

| Birch Dowels | | | | | Grooved Dowel Pins | | | |
|--------------|---------------------------|---------------------------|----------------------|--|--|---------------------------|----------------------|--|
| SIZE | PART NUMBER 36" Length | PART NUMBER 48" Length | PIECES PER BUNDLE | | SIZE | PART NUMBER 36" Length | PIECES PER BUNDLE | |
| 1/8" | 060 | 060A | 100 |  |  | 90DP | 500 | |
| 3/16" | 061 | 061A | 100 | |  | 91DP | 500 | |
| 1/4" | 062 | 062A | 100 | |  | 92DP | 500 | |
| 5/16" | 063 | 063A | 100 | |  | 93DP | 500 | |
| 3/8" | 064 | 064A | 50 | |  | 94DP | 500 | |
| 7/16" | 065 | 065A | 50 | |  | 95DP | 500 | |
| 1/2" | 066 | 066A | 50 | |  | 96DP | 500 | |
| 5/8" | 067 | 067A | 50 | | | | | |
| 3/4" | 068 | 068A | 50 | | | | | |
| 7/8" | 069 | 069A | 25 | | | | | |
| 1" | 070 | 070A | 25 | | | | | |
| 1-1/8" | 071 | 071A | 25 | | | | | |
| 1-1/4" | 072 | 072A | 25 | | | | | |

Screwhole Plugs

| Mushroom Screwhole Plugs | | | |
|---|------|--------------|----------------------|
| | SIZE | PART NUMBER | PIECES PER BUNDLE |
|  | 3/8" | 95MSP | 500 |
| | 1/2" | 96MSP | 500 |

| Cupcake Screwhole Plugs (ROUND HEAD AND FLAT HEAD) | | | |
|---|------|--------------|----------------------|
| | SIZE | PART NUMBER | PIECES PER BUNDLE |
|  | 3/8" | 90CSP | 500 |
| | 1/2" | 91CSP | 500 |



INTRODUCING... Mantel Surrounds p.13

Mantel shelves and surrounds can be used in a variety of different ways, as a traditional fireplace mantel or with shelf alone for decorative items or artwork. Our mantel shelves are constructed using solid oak and poplar and a more economical version constructed of MDF. This style of shelf is a “flush mount”, and bottom projection is 3-1/4”. Mantel Shelves can be painted, stained, or faux finished. Shelves are available in 2’-6’ lengths, and 11 different styles. Surrounds encase a fireplace, adding a complete detail around (top mantel & 2 sides).

MAJESTIC
Mantels





MANCM73P 7-1/4 x 5-1/2 **Large Dentil Poplar Majestic Mantels™ Shelf**



MANCM73O 7-1/4 x 5-1/2 **Large Dentil Oak Majestic Mantels™ Shelf**



MANCM74P 7-1/4 x 3-15/16 **Small Dentil Poplar Majestic Mantels™ Shelf**



MANCM74-O 7-1/4 x 3-15/16 **Small Dentil Oak Majestic Mantels™ Shelf**



MANCM83 7-1/4 x 5-5/16 **Embossed/Carved Majestic Mantels™ Shelf**



MAN412P 7-1/4 x 4-9/16 **Georgian Poplar Majestic Mantels™ Shelf**

(items are approximate scale only)



MAN410MUL 9-1/4 x 6 **Large Charleston Primed MDF Majestic Mantels™ Shelf**



MAN412MUL 7-1/4 x 4-9/16 **Georgian Primed MDF Majestic Mantels™ Shelf**



MAN4120 7-1/4 x 4-9/16 **Georgian Oak Majestic Mantels™ Shelf**

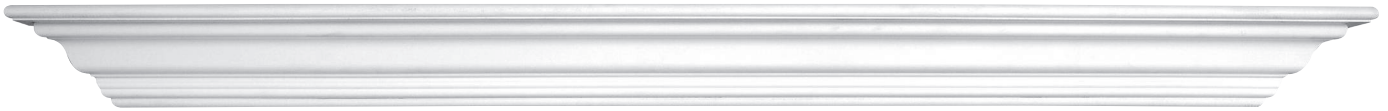

MAN413MUL 7-1/4 x 4-3/16 **Charleston Primed MDF Mantels™ Shelf**



MAN423MUL 7-1/4 x 4-3/8 **Carolina Primed MDF Majestic Mantels™ Shelf**



MAN810P 7-1/4 x 4-11/16 **Imperial Poplar Majestic Mantels™ Shelf**



MANCM8810 7-1/4 x 4-5/8 **Medium Acanthus Leaf Embossed/Carved Majestic Mantels™ Shelf**

lengths available: 2', 3', 4', 5', 6'

(items are approximate scale only)

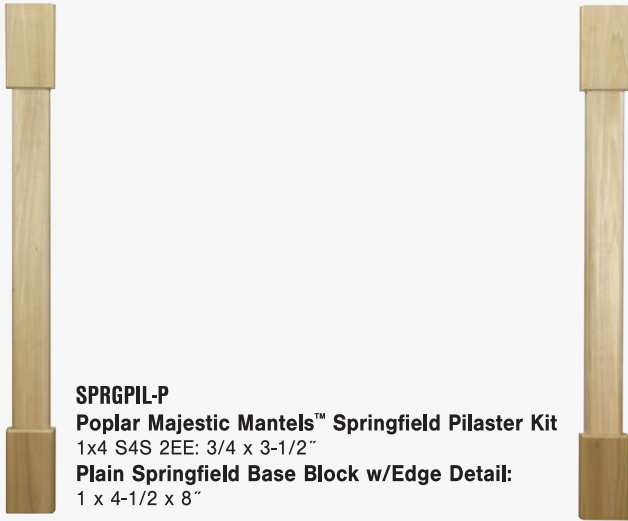

SPRGPIL-P
Poplar Majestic Mantels™ Springfield Pilaster Kit
 1x4 S4S 2EE: 3/4" x 3-1/2"
Plain Springfield Base Block w/Edge Detail:
 1 x 4-1/2" x 8"



WELLPIL-P
Poplar Majestic Mantels™ Wellington Pilaster Kit
 5-Flute & Reed Casing (Reversible): 3/4" x 3-1/2"
Base Block: 1 x 4-1/2" x 8"
Rosette: 1 x 4-1/2"



SPRGPIL-O
Oak Majestic Mantels™ Springfield Pilaster Kit
 1x4 S4S 2EE: 3/4" x 3-1/2"
Plain Springfield Base Block w/Edge Detail:
 1 x 4-1/2" x 8"



WELLPIL-O
Oak Majestic Mantels™ Wellington Pilaster Kit
 5-Flute & Reed Casing (Reversible): 3/4" x 3-1/2"
Base Block: 1 x 4-1/2" x 8"
Rosette: 1 x 4-1/2"



SPRGPIL-M
Primed MDF Majestic Mantels™ Springfield Pilaster Kit
 1x4 S4S 2EE: 3/4" x 3-1/2"
Plain Springfield Base Block w/Edge Detail:
 1 x 4-1/2" x 8"

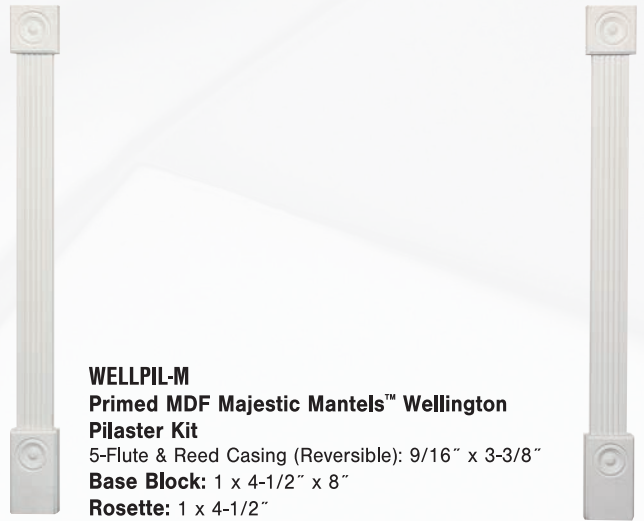

WELLPIL-M
Primed MDF Majestic Mantels™ Wellington Pilaster Kit
 5-Flute & Reed Casing (Reversible): 9/16" x 3-3/8"
Base Block: 1 x 4-1/2" x 8"
Rosette: 1 x 4-1/2"

(items are approximate scale only)



SUR-P
Poplar Majestic Mantels™ Surround Kit
Max Inner Width: 44-3/4"
Max Inner Height: 40-3/4"
Max Outer Width: 60-1/2"
Max Outer Height: 48"



SUR-O
Oak Majestic Mantels™ Surround Kit
Max Inner Width: 44-3/4"
Max Inner Height: 40-3/4"
Max Outer Width: 60-1/2"
Max Outer Height: 48"

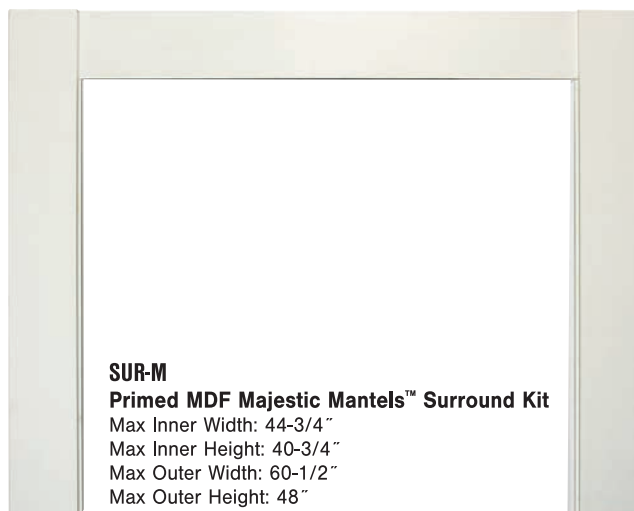

SUR-M
Primed MDF Majestic Mantels™ Surround Kit
Max Inner Width: 44-3/4"
Max Inner Height: 40-3/4"
Max Outer Width: 60-1/2"
Max Outer Height: 48"

Finishing Instructions

Majestic Mantels™ Shelves are available in MDF, Poplar, Oak, and Embossed/Carved. MDF (Medium Density Fiberboard) is made from wood fibers and is a great low cost alternative to wood. Its hard surface resists dents and scratches and its low cost will save you money on your painted applications. Poplar Majestic Mantels are made of solid clear poplar that can either be painted or stained. Oak mantels are made of clear red oak and ideal for staining. Embossed/Carved mantels are made from clear poplar. Please view the different woods with the different finish options listed.

| WOOD CHOICES | PAINTABLE | STAINABLE | FAUX FINISHED |
|-----------------|-----------|-----------|---------------|
| MDF | X | | X |
| Poplar | X | X | X |
| Oak | | X | X |
| Carved/Embossed | X | X | X |

PAINTING

- Step 1 – Choose the color of paint you wish to use.
- Step 2 – It's a good idea to test your paint color on the backside, prior to starting.
- Step 3 – Install the mantel.
- Step 4 – Fill all nail holes with putty or painters caulk.
- Step 5 – Prime the mantel before you paint (Kilz is recommended). Use either latex or oil base paint.
- Step 6 – Paint the mantel.
- Step 7 – If necessary, paint the mantel or shelf a second time.

STAINING

- Step 1 – Choose the stain finish you wish to use (Minwax® is recommended).
- Step 2 – It is recommended that you brush a small portion of the back with the stain finish and let it dry to make sure you are happy with the color. If you will be using a polyurethane finish after the stain is applied, please apply the polyurethane and let it dry to make sure you are happy with the outcome before you start on the finished side of the mantel.
- Step 3 – Install the mantel.
- Step 4 – Stain the mantel and let dry.
- Step 5 – Fill all nail holes with putty to match the stain.
- Step 6 – Brush polyurethane on the mantel and let dry.
- Step 7 – Brush polyurethane on a second time if you feel necessary.

FAUX FINISHING

It is highly recommended that when faux finishing, marbleizing, or any other exotic finishing is to be done that you consult with a professional finisher. They can literally make all the difference on a custom project. Many of these highly skilled professionals are artisans and can really add the “wow” factor to your home.

Big Ideas



Big Ideas

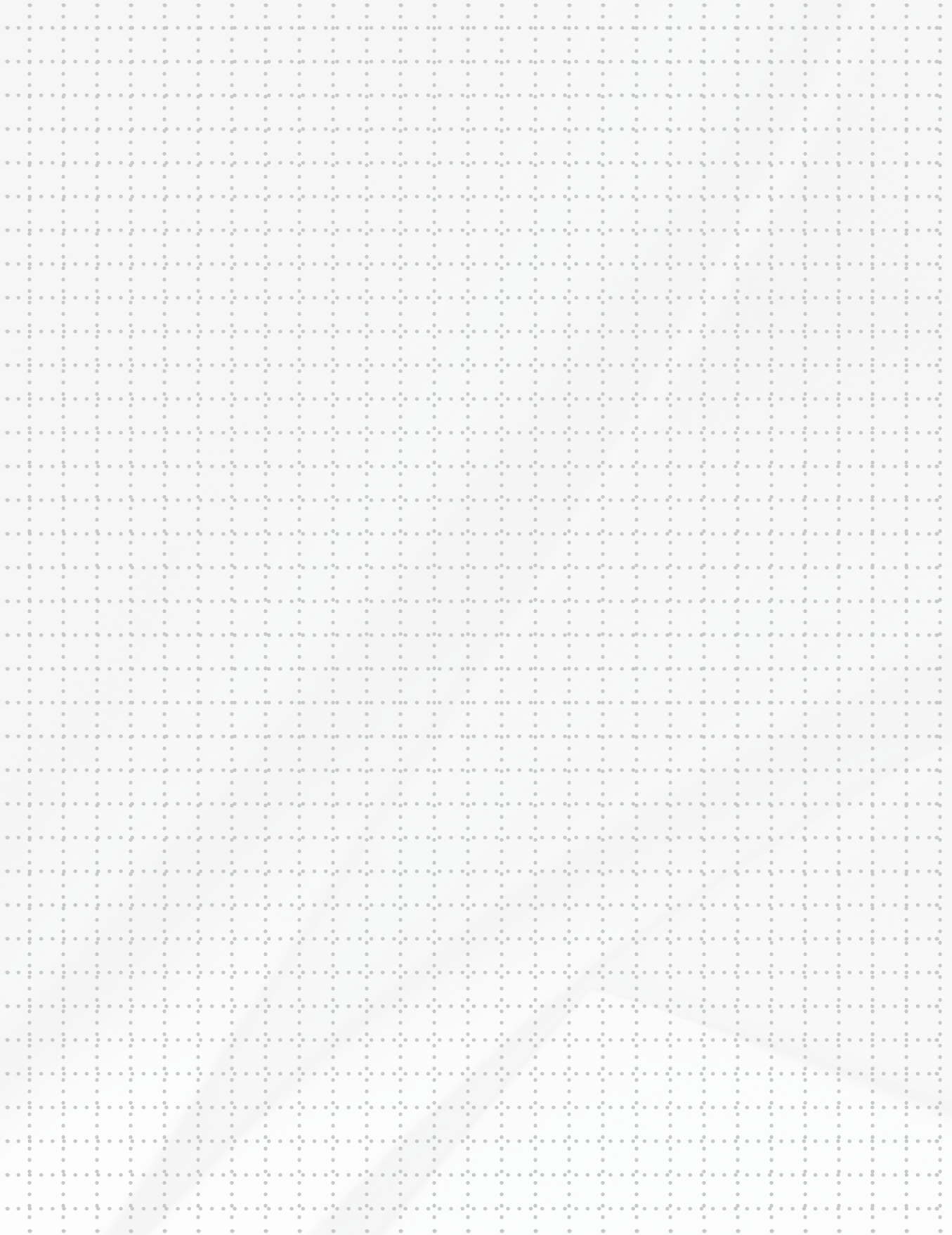

HB&G Columns & Porch Systems

THE PLACE WHERE FAMILY AND FRIENDS GREET



#1 in America, HB&G offers a wide variety of column and porch products to help you create the design that best suits your way of life. Best of all, they are the easiest to install, require little to no maintenance and come with a lifetime warranty. And with PermaCast® products you'll never have to waste time repairing or replacing them. Enjoy a beautiful, enduring structure that will improve the quality of your life for years to come.



section contents

| | |
|--------------------------------------|--------|
| Aluminum Columns..... | 39 |
| Architectural Columns | 36 |
| Bases / Columns | 18 |
| Capitals and Bases | 26, 38 |
| Craftsman PermaCast® Columns..... | 23 |
| Fluted Round PermaCast® Columns..... | 20 |
| Ordering PermaPorch® Railing | 46 |
| Ornamental Capitals | 27 |
| Painting Instructions..... | 24 |
| PermaCast® Columns..... | 17 |
| PermaLite® Columns | 31 |
| PermaPosts® / Perma Lamp Posts..... | 41 |
| PermaWrap® Columns | 28 |
| Porch and Deck Railing..... | 44 |
| Recessed Panel PermaCast® Columns .. | 22 |
| Rail Panels / Balusters | 45 |
| Round PermaCast® Columns | 19 |
| Square PermaCast® Columns | 21 |

HB&G Columns & Porch Systems

I/E

DESIGN STYLES

TRADITIONAL | COLONIAL | COASTAL

**JANKA
HARDNESS**
(POUNDS-FORCE)

N/A

ORDERING

3 WAYS TO ORDER PERMAWRAP® COLUMNS

Flat Stock

- Manufactured from 3/8" Cellular PVC
- Easy Installation
- 12' Lengths use 1/2" or 3/8" Cellular PVC
- Complete Assembly Kit Included

Assembled

- Manufactured from Cellular PVC
- Fully Assembled
- 4" x 4" Pressure Treated Post Included
- Ready to Install

L-Assembly

- Manufactured from 3/8", 1/2" or 5/8" Cellular PVC
- Shipped in two "L" shaped halves
- Square Column Ready to Wrap Around an Existing Post
- Available in Plain, Fluted, Raised Panel, Recessed Panel
- Craftsman Columns Available in Plain, Raised and Recessed Panel Styles

3 WAYS TO ORDER PERMAPORCH® RAILING

Pre-built Sections

- Shipped factory assembled
- Choose length – 4', 6', or 8' sections
 - Choose desired style
 - Note rail height (36" or 42")
- Onsite trimming ensures exact fit

Do-it-Yourself Kit

- Choose length – 6' or 8'
- Choose style – Savannah or Standard
- Kit includes:
 - Savannah or Standard top rail
 - Bottom rail
 - Aluminum inserts
 - 1 1/2" x 29 1/4" square balusters
 - 6" = 14 balusters
 - 8" = 18 balusters
 - Assembly and installation hardware
 - Support block

Individual Components

- Your design; Mix and match components
- Complete rail system requires the following:
 - Top rail – Standard or Savannah
 - Top insert – aluminum, 8', 10', 12'
 - Balusters – 28-7/8", 32", 36" and 10"
 - Bottom rail
 - Bottom insert: aluminum, 8', 10', 12'
 - Support block
 - Fastening kit

HELPFUL HINTS

* ORNAMENTAL CAPITALS

When installing a round Fiberglass column with an ornamental capital, subtract the "T" dimension (distance from top of ornament to top of neck mold) and add the height of the ornamental capital; this can lengthen or shorten the height of the column. You can find the "T" dimension in the products brochure.

* REQUIRED LOADING

Ensure concentric loading of the column. 100% of bottom must contact substrate and 75% of top must contact soffit.

* HAND RAIL

When attaching hand rails or corner irons to round or square PermaCast columns, holes must be pre-drilled.

* CAP AND BASE

Light sanding may be needed for correct fitting of base.

* Columns are not designed to be set into masonry.

* Do not fill with concrete. Concrete can be used with a barrier such as Sonatube. Leave minimum 1/2" gap to allow for expansion and contraction of the concrete.

* Columns are not designed to be used in a free standing application. If used in free standing applications a structural support must be used.

PAINTING

Round & Square PermaCast® Columns

- 1 Rinse
- 2 Prime with top quality exterior latex primer, or use an oil-based primer in accordance with paint manufacturer's instructions. A light coat of primer should be applied and allowed to cure fully.
- 3 Paint evenly with several light coats over column with a high quality exterior latex or oil-base (if primer is used) in accordance with paint manufacturer's instructions.

Do not paint PermaCast® columns using dark colors (dark colors are considered any color that falls within the L value of 56 to 0). L is a measure of lightness of an object and ranges from 0 (black) to 100 (white).

PermaWrap® Columns

- 1 Caulk where required using Siroflex brand Sealant and Adhesive provided by manufacturer. Putty any holes using acrylic putty or caulk.
- 2 Lightly sand or scuff surface of column.
- 3 Clean surface of column to remove any dirt or hand oil residue with light detergent and water, denatured alcohol, or window cleaner. Be sure to remove soap residue with clean water.
- 4 Apply one coat of 100% acrylic exterior primer and one or more finish coats of 100% acrylic exterior paint.

Do not paint columns using dark colors (dark colors are considered any color that falls within the L value of 56 to 0). L is a measure of lightness of an object and ranges from 0 (black) to 100 (white).



ALWAYS TEST TO MAKE SURE YOUR MEASURING TOOLS ARE ACCURATE. IF YOU ARE WORKING WITH A HELPER, TAKE A MEASUREMENT WITH ONE TOOL WHILE YOUR HELPER MEASURES WITH ANOTHER AND COMPARE YOUR RESULTS.



The PERMACast® Column Collection

- Weather Proof
- Insect Proof
- Load Bearing
- Low Maintenance
- Ready to Prime and Paint
- Limited Lifetime Warranty
- Custom Fluting Available
- Factory PermaPriming Available



24" Round PermaCast® Columns with Roman Corinthian Capitals

Architectural Accuracy

In the first century B.C., Vitruvius, a Roman architect and engineer, wrote what has become the most influential work on classic form. In it, he elaborates on the discovery by the ancient Greeks of entasis, a gradual tapering of the upper two-thirds of the round column which offsets the undesirable illusion from eye level that the column shaft grows larger as it ascends. HB&G round columns hold true to this classic form.



A Column To Fit Any Look

(items are approximate scale only)

HB&G PermaCast® Columns are available in round or square. The round columns are fluted, or plain, with or without the classic tapering of the upper two-thirds of the column. Square columns are available in a variety of styles as well, including plain or fluted, applied panel, recessed panel, or the craftsman style column.

The PermaCast® capitals and bases are made from durable low-maintenance materials, and like the columns, they maintain architectural authenticity and historical accuracy.



Round Plain (page 19)

Round Fluted (page 20)

Round No-Taper (page 20)

Square Fluted (page 21)

Square Recessed Panel (page 22)

Square Applied Panel (page 21)

Plain Square (page 21)

Craftsman (page 23)



Tuscan Cap (Round)



Tuscan Cap (Square)



Doric Cap (Round)



Colonial Cap (Round)



Attic Base (Round)



Crown Cap or Base



Tuscan Base Poly/Fiberglass (Round)



Tuscan Base (Square)



Doric Base (Round)



Colonial Base (Round)



Attic Base (Square)



PermaTuff™ Tuscan Base



Roman Ionic



Greek Ionic



Temple of the Winds



Roman Corinthian



Scamozzi



Colonial Cap (Square)



Roman Ionic (Square)



Greek Ionic (Square)



Temple of the Winds (Square)



Roman Corinthian (Square)



Scamozzi (Square)



Colonial Base (Square)

Round PERMACast® Columns

ROUND PERMACAST® COLUMN DIMENSIONS (IN INCHES)*

| COL. SIZE | A | B | C | D | E | F | G | J | K | L | O | N | R | T | LENGTHS AVAIL. (ft.) |
|-----------|---------|---------|---------|--------|--------|--------|---------|--------|--------|---------|--------|---------|---------|---------|--|
| 6" | 5 5/8" | 4 3/8" | 9" | 1 1/8" | 1 1/8" | 3/8" | 3/4" | 1 1/4" | 1 1/8" | 8" | 1" | 6 1/4" | 3 3/8" | 4 7/8" | 4, 6, 8 |
| 8" | 7 7/8" | 6 1/4" | 10 1/2" | 1 7/8" | 1 3/4" | 3/4" | 3/4" | 1 1/4" | 1 1/2" | 9 1/4" | 1 1/2" | 2 1/4" | 4 3/8" | 4 1/2" | 5, 6, 8, 10, 12 |
| 10" | 9 3/8" | 8 1/8" | 13 3/8" | 2 3/8" | 2 1/2" | 3/4" | 3/4" | 1 1/4" | 1 3/4" | 11 1/4" | 3/8" | 2 1/4" | 5 1/4" | 5" | 6, 8, 9, 10, 12 |
| 12" | 11 3/8" | 9 3/8" | 16 1/2" | 2 7/8" | 2 3/4" | 7/8" | 13/16" | 1 3/4" | 2 1/4" | 13 3/4" | 3/4" | 2 5/8" | 6 1/8" | 5 3/4" | 6, 8, 9, 10, 12, 14, 16, 18 |
| 14" | 13 3/8" | 11 3/8" | 19 1/2" | 3 3/8" | 3 1/2" | 1 1/8" | 7/8" | 2" | 2 7/8" | 17" | 7/8" | 2 5/8" | 7 3/8" | 7" | 8, 9, 10, 12, 14, 16, 18 |
| 16" | 15 3/4" | 13 3/8" | 22 3/8" | 4" | 3 1/2" | 1 1/8" | 1" | 2 1/4" | 3" | 19 1/4" | 1" | 3" | 8 3/8" | 8" | 8, 10, 12, 14, 16, 18, 20 |
| 18" | 17 1/2" | 15 3/8" | 24 3/4" | 4" | 4" | 1 1/8" | 1 1/8" | 2 3/4" | 3 3/8" | 22 3/8" | 1 1/2" | 10 3/4" | 9 3/8" | 8 3/4" | 10, 12, 14, 16, 18, 20, 22, 24, 26 |
| 20" | 19 1/2" | 17 1/8" | 27" | 4 1/4" | 4 1/2" | 2" | 1 7/16" | 2 7/8" | 3 3/8" | 24 1/2" | 1 1/2" | 10 3/4" | 11 1/4" | 9" | 10, 12, 14, 16, 18, 20, 22, 24 |
| 22" | 21 3/8" | 19 1/4" | 30 3/4" | 5 3/8" | 4 3/4" | 2" | 1 7/8" | 3" | 3 3/4" | 27 1/2" | 1 1/2" | 10 3/4" | 12 1/4" | 10 1/4" | 16, 18, 20, 22, 24, 26 |
| 24" | 23 3/8" | 21 1/4" | 33 1/2" | 5 7/8" | 5 1/4" | 2 1/8" | 2 1/8" | 3 1/2" | 4 1/8" | 30 1/2" | 1 1/2" | 10 3/4" | 13 1/8" | 11 1/8" | 12, 14, 16, 18, 20, 22, 24, 26, 28, 30 |
| 28" | 28" | 24 3/8" | 38" | 6 3/4" | 6" | 2 3/4" | 2 3/8" | 3 3/4" | 4 3/4" | 33 3/4" | 1 1/2" | 10 3/4" | 15 1/2" | 11 3/4" | 20, 22, 24, 26, 28 |
| 30" | 29 3/8" | 26 1/2" | 41 1/8" | 6 1/2" | 5 7/8" | 2 1/2" | 3 1/8" | 4" | 4 3/8" | 38 1/4" | 1 1/2" | 10 3/4" | 14 3/8" | 14 3/8" | 20, 22, 24, 26, 28, 30 |

*There may be a variance of up to 1/4" in all dimensions. Fluted columns available in all diameters. See page 14 for Parallel dimensions. See page 16 for Ornamental Capital dimensions. Standard Fluted Column (Fluted in mold)

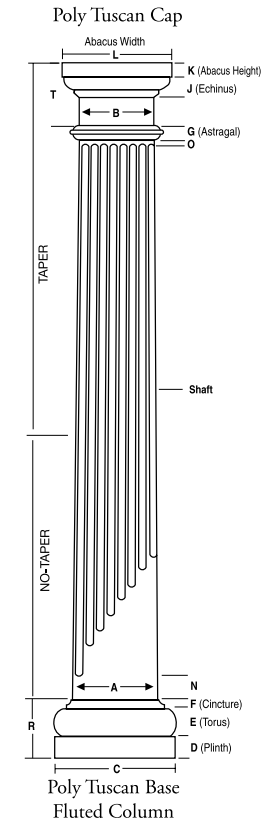
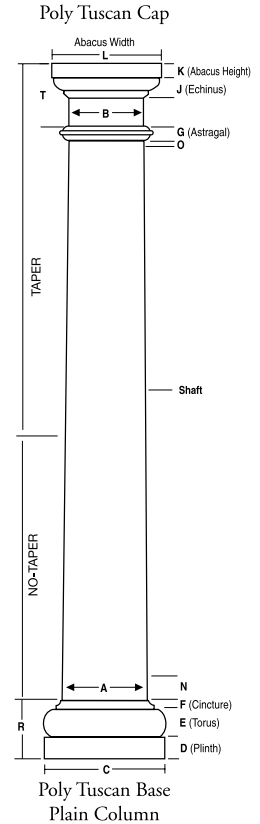

COLUMN-LOC™

Column-Loc™ creates a continuous connection from floor to beam/header without the expense of splitting and reattaching the column. This labor saving product is easy to install and delivers wind uplift resistance especially important in coastal and high wind areas. Currently available for 8 and 10" round (tapered and no-taper) and square PermaCast® columns. Kits are available with and without threaded rod.



PLUMB-FIT®

To make installation even easier our 6-12" round and square poly Tuscan Cap and Base Sets with flashing cap now come with the Plumb-Fit® installation system included.

SPLIT COLUMN ASSEMBLY KITS (FLANGE KIT)

HB&G offers a split column assembly kit that utilizes a mechanical fastening system for easy and secure assembly. This kit can be purchased separately when ordering a factory split column or they can be ordered pre-installed on factory split columns. This kit is available on select sizes.

ROUND PERMACAST® INSIDE DIMENSIONS

Inside dimension may vary up to 1/8". Splitting a column will decrease inside dimension 1/8".

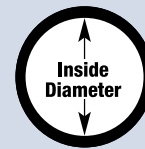

| COLUMN SIZE | TOP I.D. | BOT I.D. |
|-------------|----------|----------|
| 6" | 3 3/8" | 4 1/8" |
| 8" | 5 1/2" | 6 1/8" |
| 10" | 7 3/8" | 8 3/8" |
| 12" | 8 3/8" | 10 3/8" |
| 14" | 10 3/8" | 12 3/8" |
| 16" | 12 3/8" | 15" |
| 18" | 14 3/8" | 16 3/8" |
| 20" | 16 3/8" | 19" |
| 22" | 18 3/8" | 20 3/8" |
| 24" | 20 3/8" | 22 3/8" |
| 28" | 22" | 26 1/2" |
| 30" | 25 1/4" | 28 3/8" |

Fluted Round PermaCast® Columns

(items are approximate scale only)

Fluted Round **PERMA**Cast® Columns

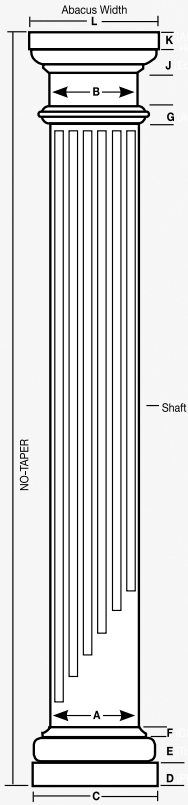

PermaCast® No-Taper column with Poly Tuscan cap and base

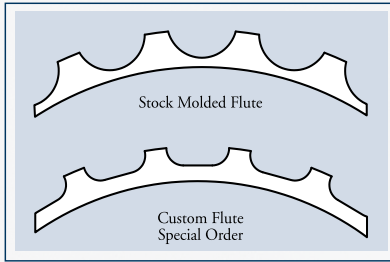

HB&G OFFERS TWO DISTINCTIVE TYPES OF FLUTES.

Stock Molded Flute: Available in diameters of 8" x 8' – 16" x 12' columns (See price guide for specific lengths available.) The stock molded flute is part of the manufacturing process and cannot be altered.

Custom Flute: The custom flute is milled after the column is manufactured and can be modified to your specific length. All round PermaCast® columns, 6" x 4' – 30" x 30', are available with an optional custom flute. (Call a customer service representative for pricing and lead times.) Adjusted Flutes available.

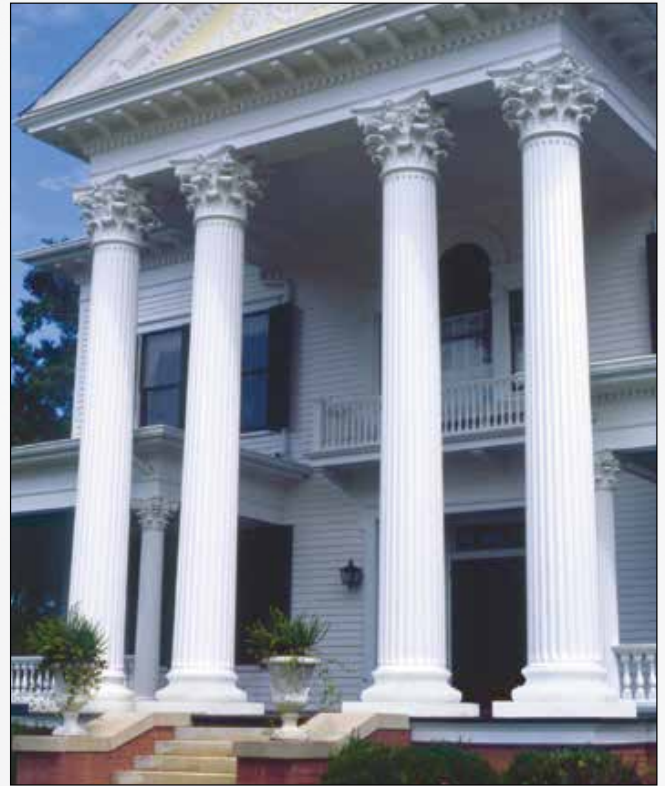

Round No-Taper **PERMA**Cast® Columns

ROUND NO-TAPER PERMACAST® COLUMN DIMENSIONS (IN INCHES)

| Col. Size | A | B | C | D | E | F | G | J | K | L | Lengths Avail. (ft.) |
|-----------|----------------------------------|----------------------------------|----------------------------------|---------------------------------|---------------------------------|----------------------------------|----------------------------------|---------------------------------|---------------------------------|------------------------------------|-------------------------|
| 8" | 7 ⁵ / ₈ " | 7 ⁵ / ₈ " | 10 ¹ / ₂ " | 1 ⁷ / ₈ " | 1 ³ / ₄ " | ³ / ₄ " | ³ / ₄ " | 1 ¹ / ₄ " | 1 ¹ / ₂ " | 10 ⁵ / ₈ " | 6,8,9,10 |
| 10" | 9 ⁵ / ₈ " | 9 ⁵ / ₈ " | 13 ¹ / ₈ " | 2 ³ / ₈ " | 2 ¹ / ₈ " | ³ / ₄ " | ³ / ₄ " | 1 ¹ / ₄ " | 1 ³ / ₄ " | 12 ¹³ / ₁₆ " | 6,8,9,10,12 |
| 12" | 11 ⁵ / ₈ " | 11 ⁵ / ₈ " | 16 ¹ / ₂ " | 2 ⁷ / ₈ " | 2 ³ / ₈ " | ⁷ / ₈ " | ¹³ / ₁₆ " | 1 ³ / ₄ " | 2" | 15 ⁷ / ₈ " | 6,8,9,10,12 |
| 14" | 13 ⁵ / ₈ " | 13 ⁵ / ₈ " | 19 ¹ / ₂ " | 3 ³ / ₈ " | 3 ¹ / ₈ " | 1 ¹ / ₈ " | ⁷ / ₈ " | 2 ¹ / ₄ " | 3" | 19 ¹ / ₈ " | 6,8,9,10,12,14 |
| 16" | 15 ³ / ₄ " | 15 ³ / ₄ " | 22 ¹ / ₈ " | 4" | 3 ¹ / ₂ " | 1 ¹ / ₈ " | 1" | 2 ¹ / ₄ " | 2 ³ / ₄ " | 22" | 6,8,9,10,12,14,16,18,20 |
| 18" | 17 ¹ / ₂ " | 17 ¹ / ₂ " | 24 ⁵ / ₈ " | 4" | 4" | 1 ⁵ / ₈ " | 1 ¹ / ₈ " | 2 ³ / ₄ " | 3 ¹ / ₈ " | 24 ⁵ / ₈ " | 6,8,9,10,12,14,16,18,20 |
| 24" | 24" | 24" | 33 ¹ / ₂ " | 5 ³ / ₄ " | 5 ¹ / ₄ " | 2 ³ / ₁₆ " | 2 ³ / ₁₆ " | 3 ¹ / ₂ " | 4 ¹ / ₈ " | 33 ³ / ₈ " | 8,10,12,14,16,18,24 |

Neck mould not included.
Flashing and Installation Kit not available with No-Taper Tuscan cap and base sets.

NECK MOULD FOR NO-TAPER COLUMN – SOLD SEPARATELY

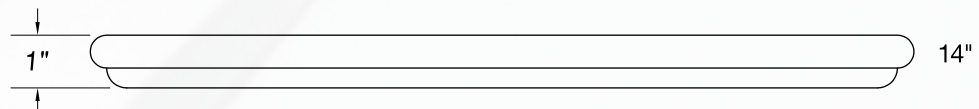
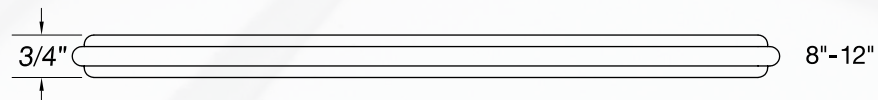

PermaCast® Plain No-Taper column with Poly Tuscan cap and base



Square PERMACast® Columns

SQUARE PERMACAST® INSIDE DIMENSIONS

Inside dimensions may vary up to 1/8".
Splitting a column will decrease inside dimension 1/8".

| COL. SIZE | INSIDE |
|-----------|---------|
| 6" | 5 1/4"* |
| 8" | 6 7/8" |
| 10" | 9" |
| 12" | 11" |
| 14" | 12" |
| 16" | 14 3/4" |

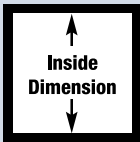

*Inside is Round

PANEL MOULDING FOR SQUARE PERMACAST®

Length: 8'
No. 54502
1/2" x 1"

Length: 10'
No. 54503
1" x 1"

Length: 10'
No. 54504
3/4" x 1"

Length: 10'
No. 54505
3/4" x 1 5/16"

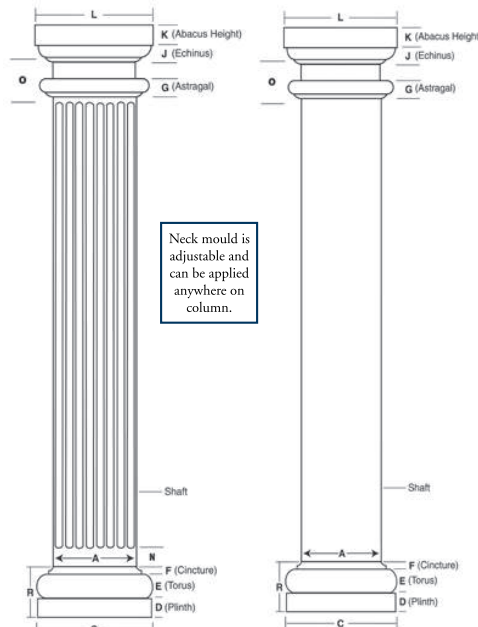

PermaCast® Square Column shown fluted with Poly Tuscan Cap and Base.

PermaCast® Square Column shown plain with Poly Tuscan Cap and Base.

Neck mould is adjustable and can be applied anywhere on column.

Plumb-Fit®

To make installation even easier our 6-12" round and square poly Tuscan Cap and Base Sets with flashing cap now come with the Plumb-Fit® installation system included.

Column-Loc™

Column-Loc™ creates a continuous connection from floor to beam/header without the expense of splitting and reattaching the column. This labor saving product is easy to install and delivers wind uplift resistance especially important in coastal and high wind areas. Currently available for 8 and 10" round (tapered and no-taper) and square PermaCast® columns. Kits are available with and without threaded rod.

SQUARE PERMACAST® COLUMN DIMENSIONS (In Inches)*

| Column Size | A | C | D | E | F | G | J | K | L | N | O | R | Lengths Available (ft.) |
|-------------|-----|----------|--------|---------|---------|--------|---------|----------|----------|-----|--------|---------|-------------------------|
| 6" | 6" | 9 3/8" | 1 1/8" | 1 1/8" | 3/8" | 1" | 1 1/4" | 1 3/8" | 9 3/8" | N/A | N/A | 3 5/8" | 6,8,9,10 |
| 8" | 8" | 11 1/8" | 1 3/8" | 1 3/4" | 5/8" | 1" | 1 3/8" | 1 3/8" | 10 1/16" | 4" | 3 1/8" | 4 1/4" | 6,8,9,10,12 |
| 10" | 10" | 13 1/16" | 2 1/8" | 2 3/16" | 3/4" | 1" | 1 1/4" | 1 13/16" | 12 3/4" | 4" | 4 1/8" | 5 1/16" | 51",6,8,9,10,12,14,16 |
| 12" | 12" | 16 1/16" | 2 3/8" | 2 3/8" | 7/8" | 1" | 1 3/4" | 2 1/16" | 16 1/16" | N/A | N/A | 6 1/16" | 8,9,10,12,14,16,18 |
| 14" | 14" | 19 3/8" | 3 1/8" | 2 7/8" | 1 1/16" | 1 1/8" | 2 1/16" | 2 1/2" | 19 1/16" | N/A | N/A | 7 9/16" | 8,10,12 |
| 16" | 16" | 22 1/8" | 3 7/8" | 3 3/8" | 1 1/8" | 1 1/8" | 2 3/8" | 2 3/4" | 21 1/2" | N/A | N/A | 8 7/8" | 8,10,12,14,16,18,20 |

☐ Fluted Square.

*There may be a variance of up to 1/4" in all dimensions.

See page 27 for Ornamental Capital dimensions.

Versatility of Square Columns

The design and versatility of an HB&G square column has enhanced its popularity with today's architects. The HB&G Square PermaCast® column lineup includes plain, recessed panel, and fluted styles. An unlimited combination of styles can be achieved by various uses of the panel moulding, neck moulding, and caps and bases. Additionally, the square column is not tapered and can be cut to any height without affecting the fit of the caps and bases.



Square Recessed PermaCast® Columns

(items are approximate scale only)

Recessed Panel **PERMA**Cast® Columns

RECESSED PANEL INSIDE DIMENSION

Inside dimension may vary up to 1/8".
Splitting a column will decrease inside dimension 1/8".

| Col. Size | Inside |
|-----------|--------|
| 8" | 5-5/8" |
| 10" | 7-1/2" |
| 12" | 9-1/2" |
| 14" | 11" |

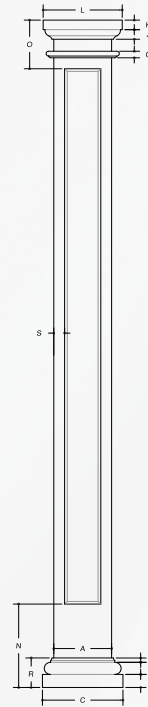
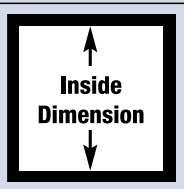

Neck mould is adjustable and can be applied anywhere on column.

Square Column with Poly Tuscan Cap and Base

SQUARE RECESSED PANEL PERMACAST® COLUMN DIMENSIONS (In Inches)*

| Column Size | A | C | D | E | F | G | J | K | L | N | O | R | S | Recess Depth | Lengths Available (ft.) |
|-------------|-----|----------|----------|---------|---------|--------|---------|----------|----------|---------|---------|---------|--------|--------------|-------------------------|
| 8" | 8" | 11 1/8" | 1 7/8" | 1 3/4" | 5/8" | 1" | 1 3/8" | 1 3/8" | 10 5/16" | 12" | 7" | 4 1/4" | 1 1/2" | 1/2" | 8,9,10 |
| 10" | 10" | 13 3/16" | 2 1/4" | 2 3/16" | 3/4" | 1 1/4" | 1 1/4" | 1 13/16" | 12 3/4" | 14 1/2" | 8 1/2" | 5 3/16" | 1 1/2" | 1/2" | 8,9,10 |
| 12" | 12" | 16 3/16" | 2 13/16" | 2 3/8" | 7/8" | 1 1/4" | 1 3/4" | 2 1/16" | 16 1/16" | 18" | 10 1/2" | 6 1/16" | 2 1/4" | 9/16" | 8,9,10,12,14 |
| 14" | 14" | 19 3/8" | 3 3/8" | 2 7/8" | 1 1/16" | 1 1/8" | 2 1/16" | 2 1/2" | 19 1/16" | 21" | 12 1/4" | 7 1/16" | 2 3/8" | 3/4" | 8,10,14 |

See page 16 for Ornamental Capital dimensions.

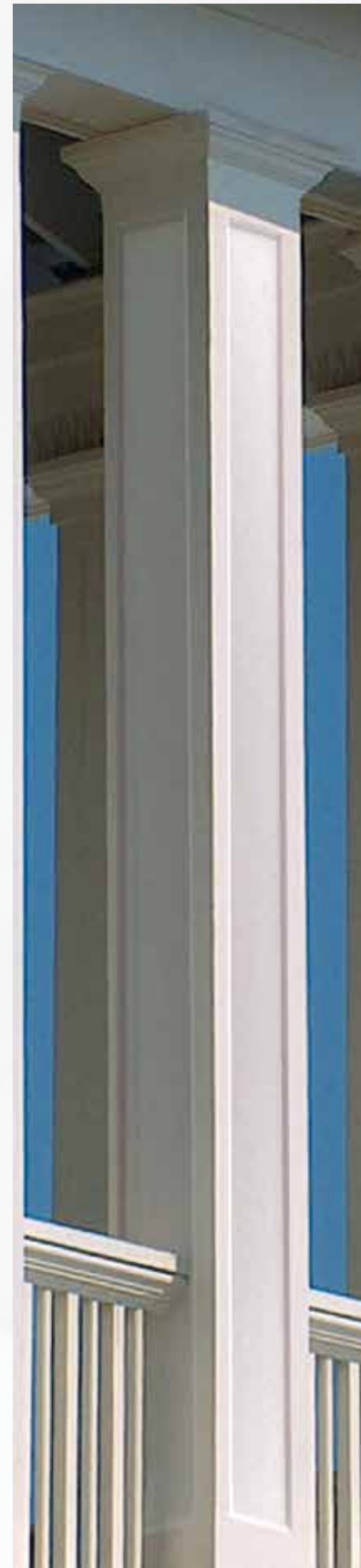

(items are approximate scale only)

Craftsman PermaCast® Columns

CRAFTSMAN PERMACAST® COLUMN

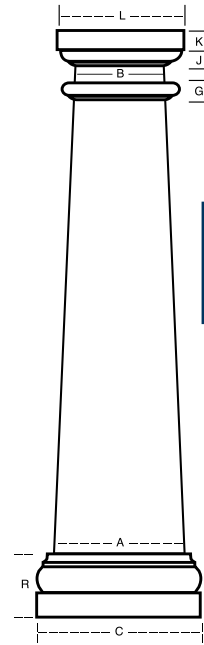

CRAFTSMAN INSIDE DIMENSION
 Inside dimension may vary up to 1/8".
 Splitting a column will decrease inside dimension 1/8".

| Column Size | Top | Bottom | |
|------------------|--------|--------|--|
| 10" x 5 1/2" | 4 1/2" | 9" | |
| 10 1/4" x 7 1/2" | 6 1/2" | 9 1/4" | |
| 10" x 8" | 6 1/2" | 8 1/2" | |
| 12" x 10" | 9" | 11" | |
| 14" x 12" | 11" | 13" | |
| 16" x 9" | 8" | 15" | |

CRAFTSMAN COLUMN DIMENSIONS (IN INCHES)

| | A | B | C | D | E | F | G | J | K | L | R | LENGTH |
|------------------|----------------|----------------|----------------|---------------|----------------|----------------|-----------|---------------|---------------|----------------|----------------|--------------------|
| 10" x 5 1/2" | 10" | 5 1/2" | 13" | 2 1/2" | 2 3/8" | 1 1/16" | 1" | 1 3/8" | 1 3/8" | 9 5/8" | 5 7/8" | 66" |
| 10 1/4" x 7 1/2" | 10 1/4" | 7 1/2" | 13 1/2" | 2 3/8" | 2 1/4" | 3/4" | 1" | 1" | 1" | 10 1/4" | 5 3/8" | 7' |
| 10" x 8" | 9 1/2" | 7 1/2" | 12 3/4" | 2 3/8" | 2 1/8" | 3/4" | 1" | 1" | 1 3/8" | 10 1/4" | 5 1/4" | 66" |
| 12" x 10" | 12" | 10" | 16 9/16" | 2 1/2" | 2 1/2" | 1 1/16" | 1" | 1 3/8" | 1 3/8" | 12 3/4" | 6 1/16" | 6', 10' |
| 14" x 12"* | 14" | 12" | 18 3/4" | 3 3/8" | 3" | 1" | 1" | 1 5/8" | 2" | 17 1/8" | 7 3/8" | 9' |
| 16" x 9" | 16" | 9" | 18 3/4" | 2 1/2" | 2 1/2" | 1 1/16" | 1" | 1 3/8" | 1 3/8" | 13 1/4" | 6 1/16" | 58" |
| 16" x 9" | 16" | 9" | 19 1/16" | 2 1/2" | 2 1/2" | 1 1/16" | 1" | 1 3/8" | 1 3/8" | 13 1/4" | 6 1/16" | 6', 8' |
| 16" x 12" | 15 1/4" | 11 1/2" | 21 1/2" | 3 7/8" | 3 5/16" | 1 3/16" | 1" | 1 3/8" | 2" | 15 1/4" | 8 7/16" | 58", 6', 8' |

*Has 1/3" to 2/3" taper.

NOTE: Neck mould is not applied. Flashing and Installation Kit is not available for Craftsman Columns with Poly Tuscan cap and base sets.



Painting Instructions

Painting Instructions

Painting instructions for round and square PermaCast® columns:

- Rinse and allow to dry completely.
- Prime with high quality exterior latex primer or use an oil-based primer in accordance with paint manufacturer's instructions. A light coat of primer should be applied and allowed to cure fully.
- Paint evenly with several light coats over column with a high quality exterior latex or oil-based (if primer is used) paint in accordance with paint manufacturer's instructions.
- Do not paint PermaCast® columns using dark colors (dark colors are considered any color that falls within the L value of 56 to 0). L is a measure of lightness of an object and ranges from 0 (black) to 100 (white).

Tips

- ✓ When ordering an ornamental capital order the appropriate base for the column.
- ✓ Ornamental capitals for square PermaCast® slide over the shaft and do not use a plug. These ornamental capitals will not lengthen or shorten the height of the column.
- ✓ When installing an ornamental capital on fluted, recessed panel, or square columns, the capital slides over the shaft. The taller capitals will cover the flutes and require additional caulking to finish.
- ✓ Verify exact opening measurement prior to ordering column length.
- ✓ When installing a PermaCast® column, verify concentric loading of column. 100% of bottom must contact substrate and 75% of top must contact soffit.
- ✓ When attaching hand rails or corner iron to PermaCast® columns, holes must be pre-drilled before applying screws.
- ✓ When ordering panel moulding for square PermaCast® columns, make sure to order enough for four sides of the column.
- ✓ Split columns are left partially intact. Cut with masonry or carbide tip blade.
- ✓ Custom split columns, caps, and bases are nonrefundable.

Splitting Options

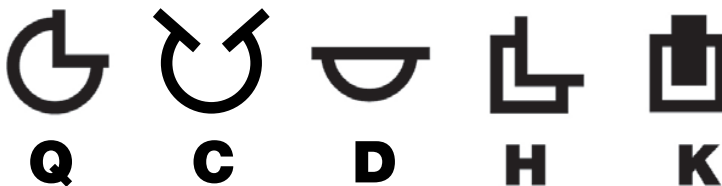

HB&G's number one goal is finding ways that we can save you time and make your life easier.

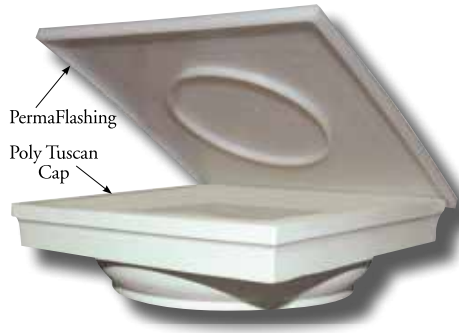

PermaCast® PermaFlashing and Installation Kit

The PermaCast® flashing with Plumb-Fit® and installation kit is available in selected Tuscan cap and base sets.*

This innovation will not only save time but will keep the elements out of the column and secure the top and bottom of the column.

*Not available in Tuscan cap and base sets for Craftsman, No-taper, PermaLite®, and Wood columns.



Round PermaCast® Porch Installation Bracket

The HB&G Porch Installation Bracket includes the bracket and all required hardware. The bracket fits 20"-30" Plain Round PermaCast® Columns and will secure a 2nd story porch to our PermaCast® Columns. Three brackets are required for each column.



| PARALLEL DIMENSIONS | | | |
|---------------------|---------------|-------------|---------------|
| Column Size | Parallel Dim. | Column Size | Parallel Dim. |
| 6x4 | 0" | 18x18 | 60" |
| 6x6 | 8" | 18x20 | 84" |
| 6x8 | 32" | 18x22 | 49" |
| 8x5 | 12" | 18x24 | 73" |
| 8x6 | 24" | 18x26 | 97" |
| 8x8 | 32" | 20x10 | 0" |
| 8x9 | 28" | 20x12 | 0" |
| 8x10 | 40" | 20x14 | 0" |
| 10x6 | 8" | 20x16 | 4" |
| 10x8 | 32" | 20x18 | 28" |
| 10x9 | 28" | 20x20 | 52" |
| 10x10 | 40" | 20x22 | 76" |
| 10x12 | 48" | 20x24 | 100" |
| 12x6 | 8" | 22x16 | 45" |
| 12x8 | 32" | 22x18 | 69" |
| 12x9 | 8" | 22x20 | 93" |
| 12x10 | 32" | 22x22 | 53" |
| 12x12 | 48" | 22x24 | 77" |
| 12x14 | 59" | 22x26 | 101" |
| 12x16 | 40" | 24x12 | 21" |
| 12x18 | 73" | 24x14 | 45" |
| 14x8 | 32" | 24x16 | 69" |
| 14x9 | 12" | 24x18 | 93" |
| 14x10 | 24" | 24x20 | 75" |
| 14x12 | 48" | 24x22 | 99" |
| 14x14 | 27" | 24x24 | 123" |
| 14x16 | 51" | 24x26 | 77" |
| 14x18 | 75" | 24x28 | 101" |
| 16x8 | 16" | 24x30 | 125" |
| 16x10 | 40" | 28x20 | 20" |
| 16x12 | 29" | 28x22 | 44" |
| 16x14 | 53" | 28x24 | 68" |
| 16x16 | 36" | 28x26 | 92" |
| 16x18 | 60" | 28x28 | 116" |
| 16x20 | 84" | 30x20 | 56" |
| 18x8 | 0" | 30x22 | 80" |
| 18x10 | 16" | 30x24 | 140" |
| 18x12 | 40" | 30x26 | 75" |
| 18x14 | 48" | 30x28 | 99" |
| 18x16 | 36" | 30x30 | 123" |

| Column Size | Bottom Diameter |
|-------------|------------------------------------|
| 6x4 | 5 ³ / ₈ " |
| 18x8 | 17 ¹ / ₄ " |
| 20x10 | 18 ¹¹ / ₁₆ " |
| 20x12 | 18 ⁵ / ₁₆ " |
| 20x14 | 19 ¹ / ₄ " |

PERMA Capitals and Bases

About EL & EL Capitals & Bases

EL & EL manufactures capitals and bases, made from high grade urethane, that are extremely strong, dense, and durable. Use product codes with a '-E' to ensure ordering a column system using HB&G's superior column shafts with EL & EL's high grade urethane capitals and bases. Please note that EL & EL capitals do not include the cap flashing. Please order Round Flashing Caps (RFC) when a flashing cap is desired with an EL & EL capital.

CAPITAL AND BASE OPTIONS

Most capitals and bases for PermaCast® columns are made of polyurethane and are decorative. The shaft fits through the center of the capital and base and does not alter the height of the shaft. Ornamental capitals for round PermaCast® columns will alter the height of the shaft.

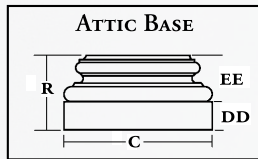

TUSCAN CAP AND BASES

The Tuscan style is standard and best complements the PermaCast® column. The Tuscan is available for all round and square shafts. For dimension see pages 26, 27 and 38.

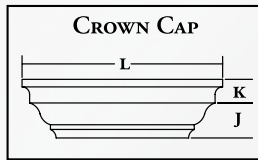

ORNAMENTAL CAPITAL

Five styles of ornamental capitals are available for all round and square shafts. Using an ornamental capital with a round PermaCast® shaft will alter the height of the shaft. Ornamental capitals do not alter the height of the shaft when used on a square PermaCast® Column.

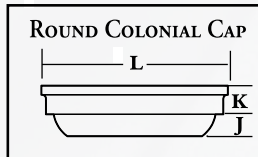

ATTIC BASE

Attic Bases are used for a more ornate look and come in 1 or 2 pieces depending on their size.

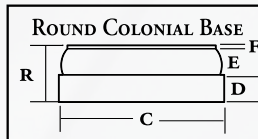

COLONIAL CAP AND BASE

Referred to as our low profile cap and base, the Colonial are designed specifically for use in applications where railing will be attached to the column. Available for PermaCast® round and square shafts 6"-12".

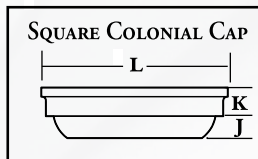

FIBERGLASS BASE

The fiberglass base is manufactured from the same materials as the shaft and is available for Round PermaCast® shafts 8"-14" only. It is designed to be used in high traffic areas.

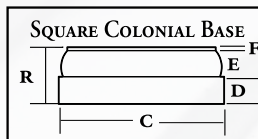

PERMA TUFF® CAP AND BASE

A durable hard shell base combined with a poly cap. Designed for high traffic applications. Available for PermaCast® round shafts 8"-12".

DIMENSIONS OF ATTIC BASE FOR ROUND AND SQUARE COLUMNS

| COLUMN SIZE | ROUND ATTIC | | | | COLUMN SIZE | SQUARE ATTIC | | | |
|-------------|-------------|--------|---------|---------|-------------|--------------|--------|--------|---------|
| | C | DD | EE | R | | C | DD | EE | R |
| 6" | 8 5/16" | 1 3/8" | 2 3/4" | 4 1/8" | 6" | 8 7/16" | 1 3/8" | 2 7/8" | 4 1/4" |
| 8" | 10 1/8" | 1 7/8" | 3 3/4" | 5 1/8" | 8" | 11" | 1 7/8" | 3 1/4" | 5 1/8" |
| 10" | 13" | 2 1/2" | 3 3/8" | 6 3/8" | 10" | 13 3/8" | 2 3/8" | 4" | 6 3/8" |
| 12" | 16 1/8" | 3" | 4 1/2" | 7 1/2" | 12" | 17" | 2 3/4" | 4 1/2" | 7 1/4" |
| 14" | 19 1/4" | 3 3/8" | 5 3/8" | 8 3/4" | N/A | N/A | N/A | N/A | N/A |
| 16" | 21 1/4" | 4" | 6 1/2" | 10 1/2" | 16" | 22 3/8" | 4" | 6 5/8" | 10 3/8" |
| 18" | 25" | 4 3/8" | 7 1/4" | 11 5/8" | N/A | N/A | N/A | N/A | N/A |
| 20" | 27 1/16" | 4 7/8" | 8 1/4" | 13 3/8" | N/A | N/A | N/A | N/A | N/A |
| 22" | 30 1/4" | 5 3/8" | 9 1/4" | 14 3/8" | N/A | N/A | N/A | N/A | N/A |
| 24" | 33 1/2" | 6" | 10 1/4" | 16 1/4" | N/A | N/A | N/A | N/A | N/A |
| 28" | 38" | 6 3/4" | 11 3/8" | 18 1/8" | N/A | N/A | N/A | N/A | N/A |
| 30" | 41 1/4" | 6 1/2" | 11 1/4" | 17 3/4" | N/A | N/A | N/A | N/A | N/A |

CROWN CAP FOR SQUARE COLUMN DIMENSIONS

| Column Size | K | J | L |
|-------------|---------|---------|---------|
| 6" | 1 9/16" | 2 5/16" | 11 1/4" |
| 8" | 1 9/16" | 2 5/16" | 13 1/4" |
| 10" | 1 9/16" | 2 5/16" | 15 1/4" |
| 12" | 1 9/16" | 2 5/16" | 17 1/4" |

COLONIAL ROUND CAP AND BASE DIMENSIONS*

| Col. Size | C | D | E | F | J | K | L | R |
|-----------|----------|--------|---------|------|---------|--------|----------|--------|
| 6" | 7 1/4" | 1 3/8" | 1 1/4" | 1/4" | 1" | 1 1/4" | 7" | 2 7/8" |
| 8" | 9 1/8" | 1 1/2" | 1 5/16" | 1/4" | 1 1/16" | 1 3/8" | 9" | 3" |
| 10" | 11 3/16" | 1 1/2" | 1 1/4" | 1/4" | 1 1/16" | 1 3/8" | 10 9/16" | 3" |
| 12" | 13 1/8" | 1 1/2" | 1 1/4" | 1/4" | 1 1/16" | 1 3/8" | 12" | 3" |

*Low profile option.

COLONIAL SQUARE CAP AND BASE DIMENSIONS*

| Col. Size | C | D | E | F | J | K | L | R |
|-----------|---------|--------|---------|-------|--------|--------|---------|--------|
| 6" | 8 3/8" | 1 1/4" | 1 1/16" | 7/16" | 5/8" | 1" | 7 5/16" | 2 3/4" |
| 8" | 10 5/8" | 1 1/4" | 1 1/16" | 7/16" | 15/16" | 1" | 9 5/16" | 2 3/4" |
| 10" | 12 3/8" | 1 1/4" | 1 1/16" | 7/16" | 15/16" | 1 1/4" | 12 3/8" | 2 3/4" |
| 12" | 14 3/8" | 1 1/4" | 1 1/16" | 7/16" | 1" | 1 3/8" | 14 3/8" | 2 3/4" |

*Low profile option.



PermaWrap® Columns NON-STOCK
SPECIAL ORDER ITEM

PERMAWrap®
C O L U M N S

- 25 year limited warranty
- Custom styles available
- Made from cellular PVC
- Installation kit included
- Interior and exterior use
- Weather proof
- Insect proof
- Low maintenance



12" PermaWrap® Column with
Tuscan Base and Custom Cap

Custom PermaWrap® Columns

From 5" to 24" wide and 2' to 20' in length, you can now order the perfect custom column for your home or neighborhood project. Custom columns are manufactured using 3/8", 1/2", or 5/8" cellular PVC. Ask HB&G today how you can put a unique signature on your next custom project. Simply visit our website, www.hbgcolumns.com, or contact our Architectural Department at 1-800-264-4HBG (4424).

Two Ways to Order PermaWrap® Columns



Assembled

L-Assembly

- Assembled**
- Manufactured from cellular PVC
 - Fully Assembled (with or without post)
 - Ready to Install

- L-Assembly**
- Manufactured from 3/8", 1/2", or 5/8" cellular PVC
 - Shipped in two L-shaped halves
 - Square Column Ready to Wrap Around an Existing Post
 - Available in Plain, Fluted, Raised Panel, or Recessed Panel
 - Craftsman Columns Available in Plain, Raised, and Recessed Panel Styles

(items are approximate scale only)

NON-STOCK
SPECIAL ORDER ITEM

PermaWrap® Columns



24" x 18' Square Recessed PermaWrap® Columns

Leading the industry in column innovation, HB&G PermaWrap® columns are made from cellular PVC and offer the advantages of being unaffected by moisture and insects but with the thickness, ease of use, and workability of wood.

PermaWrap® columns are available in all sizes and styles – square or craftsman – plain, fluted, raised panel, and recessed panel. With all of these options, you are certain to find just the right amount of detail for your specific project.

Best of all, the PermaWrap® column comes with a 25-year HB&G warranty.



10" x 8' Custom Raised Panel Square PermaWrap® Columns and Custom Rail Design



14" x 10' Custom Raised Panel PermaWrap® Columns



16" x 6' Craftsman PermaWrap® Column with Pedestal

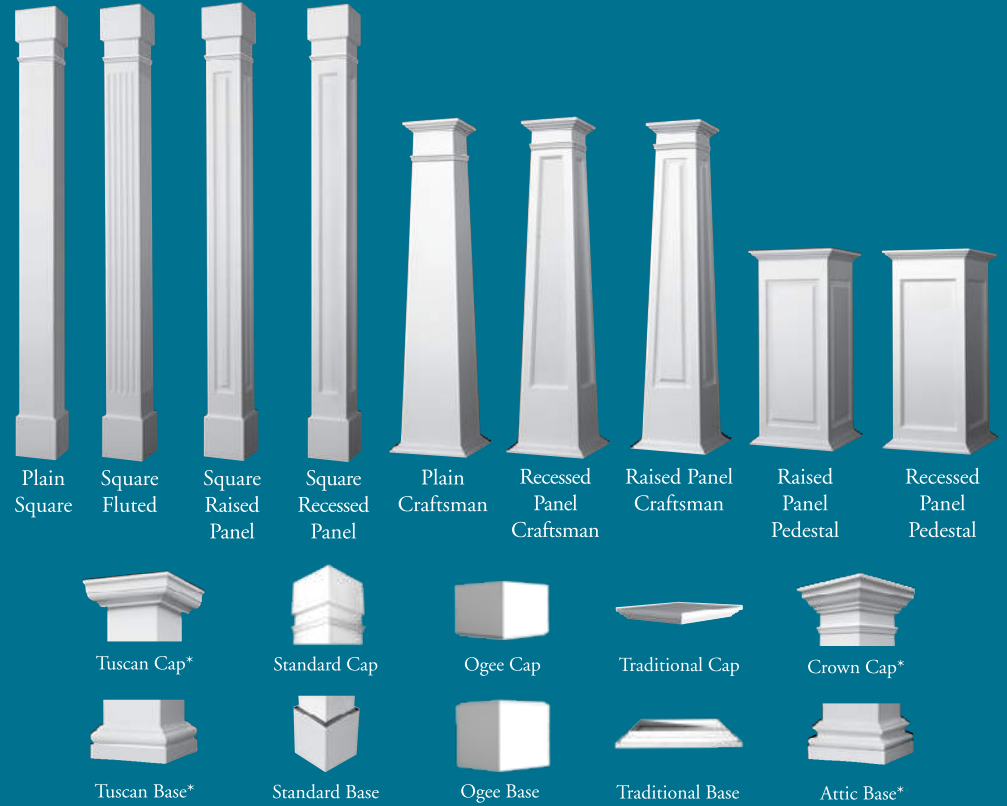

*Made from polyurethane and may need to be split in the field for installation.

Examples of custom PermaWrap® columns

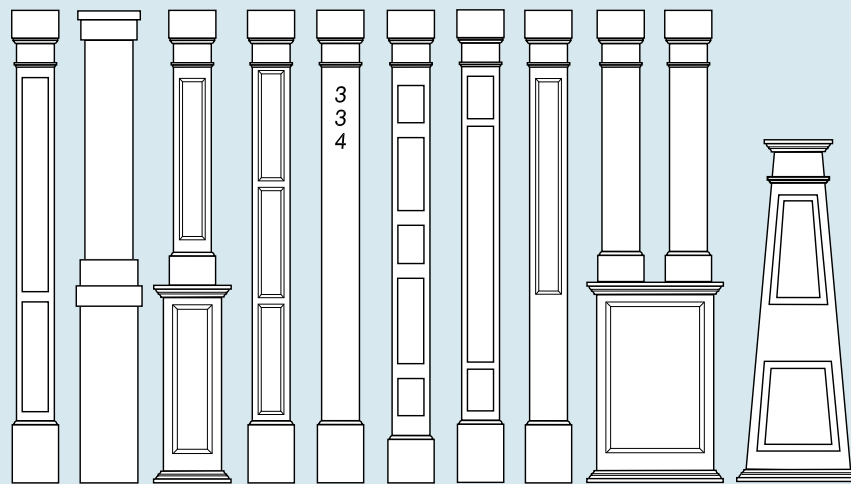

PLAIN PERMAWRAP® DIMENSIONS (IN INCHES)

| | Col Width | A | C | G | L | R | U | Lengths |
|------------|-----------|----------------------------------|----------------------------------|----|----------------------------------|----|----|--------------|
| Assembled | 6" | 5 ⁷ / ₈ " | 7 ¹ / ₈ " | 1" | 7 ¹ / ₈ " | 9" | 7" | 8', 10' |
| | 8" | 7 ⁷ / ₈ " | 9 ¹ / ₈ " | 1" | 9 ¹ / ₈ " | 9" | 7" | 8', 10', 12' |
| | 10" | 9 ⁷ / ₈ " | 11 ¹ / ₈ " | 1" | 11 ¹ / ₈ " | 9" | 7" | 8', 10', 12' |
| | 12" | 11 ⁷ / ₈ " | 13 ¹ / ₈ " | 1" | 13 ¹ / ₈ " | 9" | 7" | 8', 10', 12' |
| L Assembly | 6" | 5 ⁷ / ₈ " | 7 ¹ / ₈ " | 1" | 7 ¹ / ₈ " | 9" | 7" | 8', 10' |
| | 8" | 7 ⁷ / ₈ " | 9 ¹ / ₈ " | 1" | 9 ¹ / ₈ " | 9" | 7" | 8', 10', 12' |
| | 10" | 9 ⁷ / ₈ " | 11 ¹ / ₈ " | 1" | 11 ¹ / ₈ " | 9" | 7" | 8', 10', 12' |
| | 12" | 11 ⁷ / ₈ " | 13 ¹ / ₈ " | 1" | 13 ¹ / ₈ " | 9" | 7" | 8', 10', 12' |

Additional sizes are available from 5" to 24" wide and 2' to 20' in length.

INSIDE DIMENSIONS

| | |
|-----|----------------------------------|
| 6" | 4 ³ / ₈ " |
| 8" | 6 ³ / ₈ " |
| 10" | 8 ³ / ₈ " |
| 12" | 10 ³ / ₈ " |

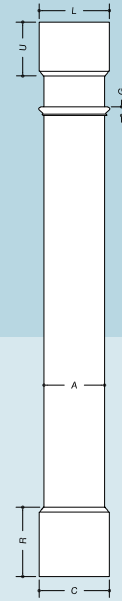
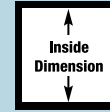

PERMAWRAP® FLUTED, RECESSED PANEL, AND RAISED PANEL DIMENSIONS (IN INCHES)

| Col Width | A | C | G | L | N | O | S* | R | U | Lengths |
|-----------|----------------------------------|----------------------------------|---------------------------------|----------------------------------|----|----|---------------------------------|----|----|----------------------|
| 6" | 5 ⁷ / ₈ " | 7 ¹ / ₈ " | 1 ¹ / ₈ " | 7 ¹ / ₈ " | 6" | 6" | 1 ³ / ₄ " | 9" | 7" | 6', 8', 9', 10', 12' |
| 8" | 7 ⁷ / ₈ " | 9 ¹ / ₈ " | 1 ¹ / ₈ " | 9 ¹ / ₈ " | 6" | 6" | 1 ³ / ₄ " | 9" | 7" | 6', 8', 9', 10', 12' |
| 10" | 9 ⁷ / ₈ " | 11 ¹ / ₈ " | 1 ¹ / ₈ " | 11 ¹ / ₈ " | 6" | 6" | 1 ³ / ₄ " | 9" | 7" | 6', 8', 9', 10', 12' |
| 12" | 11 ⁷ / ₈ " | 13 ¹ / ₈ " | 1 ¹ / ₈ " | 13 ¹ / ₈ " | 6" | 6" | 1 ³ / ₄ " | 9" | 7" | 6', 8', 9', 10', 12' |

Rail breaks are 7" long and designed to fit 36" or 42" rail heights.

*S dimension for 6" raised panel is 1-1/4", 8" raised panel is 1-1/2".

S dimension for fluted columns vary.

Additional sizes are available from 5" to 24" wide and 2' to 20' in length.

INSIDE DIMENSIONS

| | |
|-----|---------------------------------|
| 6" | 3 ⁷ / ₈ " |
| 8" | 5 ⁷ / ₈ " |
| 10" | 7 ⁷ / ₈ " |
| 12" | 9 ⁷ / ₈ " |

NUMBER OF FLUTES PER SIDE

| | |
|-----|---|
| 6" | 3 |
| 8" | 5 |
| 10" | 7 |
| 12" | 8 |

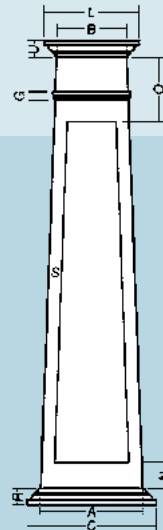
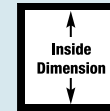

PERMAWRAP® CRAFTSMAN DIMENSIONS (IN INCHES)

| Col Width | A | B | C | G | L | N | O | S | R | U | Lengths |
|-----------|----------------------------------|----------------------------------|----------------------------------|---------------------------------|----------------------------------|----|----|---------------------------------|----|----|------------------------------|
| 12"X8" | 11 ⁷ / ₈ " | 7 ⁷ / ₈ " | 14 ⁷ / ₈ " | 1 ¹ / ₈ " | 10 ⁷ / ₈ " | 6" | 6" | 1 ³ / ₄ " | 2" | 2" | 54", 60", 66", 72", 84", 96" |
| 16"X10" | 15 ⁷ / ₈ " | 9 ⁷ / ₈ " | 18 ⁷ / ₈ " | 1 ¹ / ₈ " | 12 ⁷ / ₈ " | 6" | 6" | 1 ³ / ₄ " | 2" | 2" | 54", 60", 66", 72", 96" |
| 20"X15" | 19 ⁷ / ₈ " | 14 ⁷ / ₈ " | 22 ⁷ / ₈ " | 1 ¹ / ₈ " | 17 ⁷ / ₈ " | 6" | 6" | 1 ³ / ₄ " | 2" | 2" | 54", 60", 66", 72", 96" |

Additional sizes are available from 5" to 24" wide and 2' to 20' in length.

INSIDE DIMENSIONS

| | Bottom | Top |
|-----------|----------------------------------|----------------------------------|
| 12" x 8" | 10 ³ / ₈ " | 5 ⁷ / ₈ " |
| 16" x 10" | 14 ³ / ₈ " | 6 ⁷ / ₈ " |
| 20" x 15" | 18 ³ / ₈ " | 12 ⁷ / ₈ " |

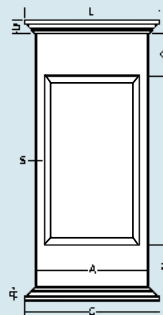
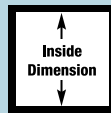

PERMAWRAP® PEDESTAL DIMENSIONS (IN INCHES)

| Col Width | A | C | L | N | O | S | R | U | Lengths |
|-----------|----------------------------------|----------------------------------|----------------------------------|----|----|---------------------------------|----|----|----------|
| 16" | 15 ⁷ / ₈ " | 18 ⁷ / ₈ " | 18 ⁷ / ₈ " | 6" | 6" | 1 ³ / ₄ " | 2" | 2" | 40", 46" |
| 20" | 19 ⁷ / ₈ " | 22 ⁷ / ₈ " | 22 ⁷ / ₈ " | 6" | 6" | 1 ³ / ₄ " | 2" | 2" | 40", 46" |
| 24" | 23 ⁷ / ₈ " | 26 ⁷ / ₈ " | 26 ⁷ / ₈ " | 6" | 6" | 1 ³ / ₄ " | 2" | 2" | 40", 46" |

Additional sizes are available from 5" to 24" wide and 2' to 20' in length.

INSIDE DIMENSIONS

| | |
|-----|----------------------------------|
| 16" | 13 ⁷ / ₈ " |
| 20" | 15 ⁷ / ₈ " |
| 24" | 21 ⁷ / ₈ " |

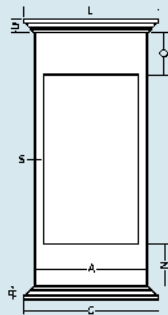
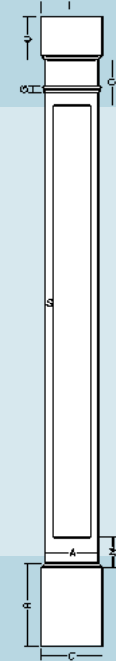
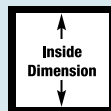

PVC Painting and Finishing

Caulk where required using Siroflex brand Sealant and Adhesive provided by manufacturer. Putty any holes using acrylic putty or caulk. Lightly sand or scuff surface of column. Clean surface of column to remove any dirt or hand oil residue with light detergent and water, denatured alcohol, or window cleaner. Be sure to remove soap residue with clean water. Apply one coat of 100% acrylic exterior primer and one or more finish coats of 100% acrylic exterior paint.

Do not paint columns using dark colors (dark colors are considered any color that falls within the L value of 56 to 0). L is a measure of lightness of an object and ranges from 0 (black) to 100 (white).

PermaLite[®] Columns

- Weather Proof
- Insect Proof
- Load Bearing
- Low Maintenance
- Lightweight
- Ready to Prime and Paint
- Limited Lifetime Warranty



PermaLite™ Square Columns

(items are approximate scale only)

HB&G PermaLite® columns are cost effective, load bearing, versatile, and require very little maintenance. The PermaLite® columns are available in round and square. PermaLite® columns deliver all of the beauty at 1/3 of the weight.



PermaLite®
Round
No-Taper

PermaLite®
Square Plain

PermaLite®
Square Recessed
(with panel kit)

PermaLite® Square
Recessed (with panel
divider kit)

PermaLite® Square
Recessed (with 2-panel
divider kits)

TOP VIEW CUT-AWAY

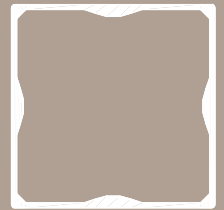

PermaLite® Plain



PermaLite® Recessed



PermaLite® Round



Square Tuscan Cap



Round Tuscan Cap



Square Tuscan Base



Round Tuscan Base

For
Tuscan
Cap and Base
Dimensions
please see p.27

(items are approximate scale only)

PermaLite™ Square Columns

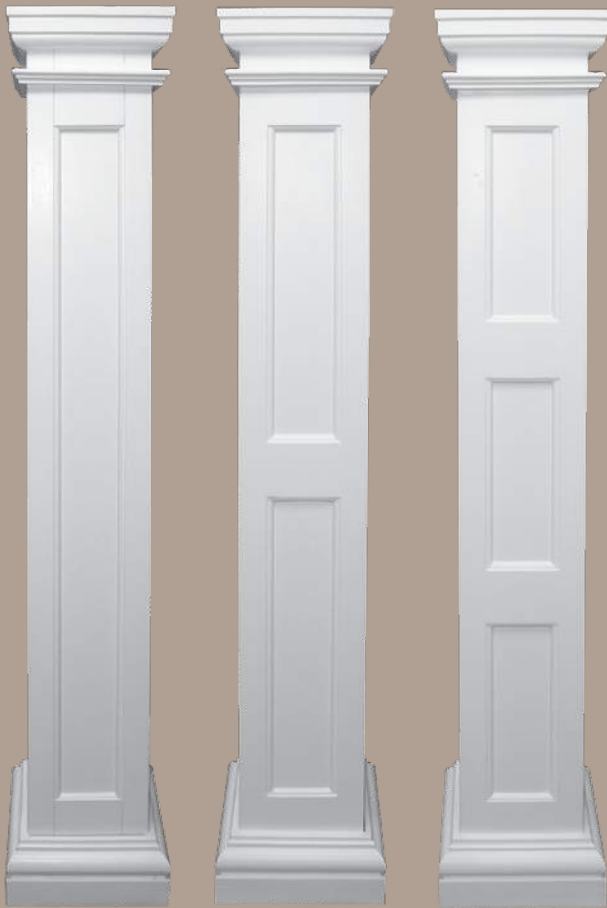

PERMALITE® PANEL DIVIDER KITS TO CONVERT A SINGLE PANEL COLUMN INTO A 2 OR 3-PANEL COLUMN

RECESSED – Includes four top panel insert pieces and four bottom panel insert pieces. **PANEL DIVIDER KITS** are available.

| Kit Size | Width | Height |
|-------------------------------------|----------------------------------|---------------------------------|
| 8" Panel Divider Kit (4 Pieces) | 4 ⁷ / ₈ " | 2 ¹ / ₄ " |
| 10" Panel Divider Kit (4 Pieces) | 5 ⁵ / ₁₆ " | 5 ¹ / ₈ " |

1 panel kit to achieve 2-panel column.
2 panel kits to achieve 3-panel column.

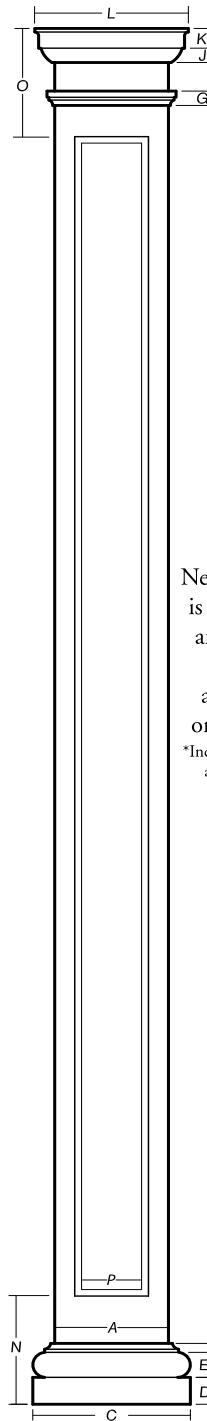

PermaLite® Square Column shown with Tuscan Cap and Base

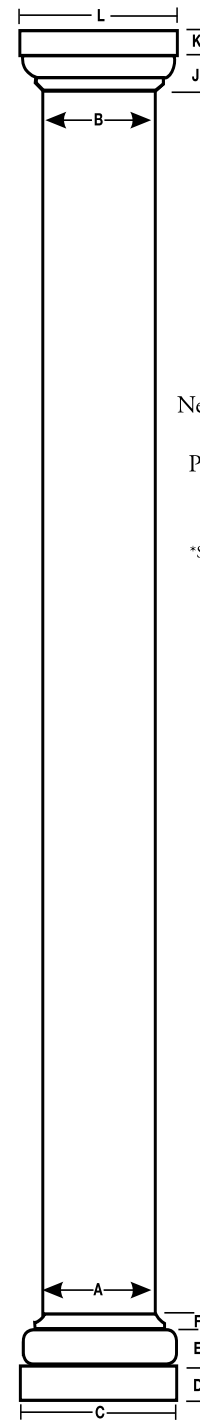

PermaLite® Round No-Taper Column shown with Tuscan Cap and Base

Neck Mould* is adjustable and can be applied anywhere on column. *Included with cap and base set.

Neck Mould* for PermaLite® Round Column *Sold separately



PermaLite™ Square Columns

(items are approximate scale only)

PLAIN AND RECESSED PANEL SQUARE PERMALITE® COLUMN DIMENSIONS (IN INCHES)

| Col. Size | A | C | D | E | F | G | J | K | L | N | O | P | Lengths Avail. (ft.) |
|-----------|---------|-----------|----------|----------|--------|----|---------|---------|----------|-----|-----|--------|----------------------|
| 6" | 5-1/2" | 8-1/2" | 1-1/2" | 1-1/4" | 1/2" | 1" | 7/8" | 1-1/16" | 8" | N/A | N/A | N/A | 6, 8, 9, 10 |
| 8" | 7-1/2" | 11" | 1-15/16" | 1-11/16" | 3/4" | 1" | 1" | 1-7/16" | 10-1/16" | 8" | 8" | 3-7/8" | 6, 8, 9, 10, 12 |
| 8"* | 7-1/2" | 10-7/16" | 1-7/8" | 1-11/16" | 5/8" | 1" | 1" | 1-3/8" | 10-1/4" | 8" | 8" | 3-7/8" | 6, 8, 9, 10, 12 |
| 10" | 9-1/2" | 12-15/16" | 2-1/2" | 2-1/8" | 3/4" | 1" | 1-5/16" | 1-3/4" | 12-3/4" | 9" | 9" | 4-3/8" | 6, 8, 9, 10, 12 |
| 10"* | 9-1/2" | 13-1/8" | 2-3/8" | 2-1/8" | 3/4" | 1" | 1-1/4" | 1-3/4" | 12-3/4" | 9" | 9" | 4-3/8" | 6, 8, 9, 10, 12 |
| 12" | 11-1/2" | 15-1/4" | 2-3/4" | 2-7/16" | 13/16" | 1" | 1-3/8" | 2" | 15-7/8" | N/A | N/A | N/A | 6, 8, 9, 10, 12 |

- * Sim caps and bases. The remainder are poly caps and bases.
- See drawing on page 30.

NOTES: Recessed Panel top inset – 8" = 8", 10" = 9"; Bottom inset – 8" = 8", 10" = 9". Neck mould is adjustable and is applied in the field. Recessed Panel available in 8" and 10" sizes only. Factory split PermaLite® columns are not available. HB&G does not recommend splitting PermaLite® columns.

SQUARE PERMALITE® INSIDE DIMENSION

| Col. Width | Inside |
|------------|---------|
| 6" | 4-5/8" |
| 8" | 6-5/8"* |
| 10" | 8-5/8"* |
| 12" | 10-5/8" |

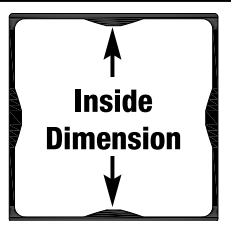

COLONIAL SQUARE CAP AND BASE FOR PERMALITE®

| Col. Size | C | D | E | F | J | K | L | R |
|-----------|---------|--------|---------|-------|--------|--------|---------|--------|
| 6" | 8 1/8" | 1 1/4" | 1 1/16" | 7/16" | 5/8" | 1" | 7 7/16" | 2 3/4" |
| 8" | 10 1/8" | 1 1/4" | 1 1/16" | 7/16" | 15/16" | 1" | 9 7/16" | 2 3/4" |
| 10" | 12 1/8" | 1 1/4" | 1 1/16" | 7/16" | 15/16" | 1 1/4" | 12 1/8" | 2 3/4" |
| 12" | 14 1/8" | 1 1/4" | 1 1/16" | 7/16" | 1" | 1 3/8" | 14 1/4" | 2 3/4" |

- Neck moulding is 4 pieces included with the cap and base.
- See drawings on page 30.

*Recessed Panel Inside Dimensions 8" - 5-5/8"; 10" - 7-5/8"

ROUND PERMALITE® NO-TAPER COLUMN DIMENSIONS

| Col. Size | A | B | C | D | E | F | J | K | L | Lengths |
|-----------|--------|--------|---------|--------|--------|------|--------|--------|---------|----------------------|
| 8" | 7-5/8" | 7-5/8" | 10-1/2" | 1-7/8" | 1-3/4" | 3/4" | 1-1/4" | 1-1/2" | 10-5/8" | 6', 8', 9', 10' |
| 10" | 9-5/8" | 9-5/8" | 13-1/8" | 2-3/8" | 2-1/8" | 3/4" | 1-1/4" | 1-3/4" | 12-3/4" | 6', 8', 9', 10', 12' |

ROUND PERMALITE® DIMENSIONS

Inside diameter may vary up to 1/8".

| COLUMN SIZE | ID |
|-------------|--------|
| 8" | 7-3/8" |
| 10" | 9-3/8" |

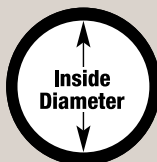

One Piece Neck Mould
for 8" and 10" Round
No-Taper Column
Is Available.

Neck Ring Sold Separately.



(items are approximate scale only)

NON-STOCK
SPECIAL ORDER ITEM

PermaSnap™ Column Wrap

PermaSnap™ Column Wrap

- 25 Year Limited Warranty
- Low Maintenance
- Weather Proof
- Made from cPVC
- Insect Proof
- Easy Installation

Transform a treated post into a finished column in minutes with PermaSnap™. PermaSnap™ column wrap's patented snap design permits easy installation by one person. It can also be used as a newel post wrap.

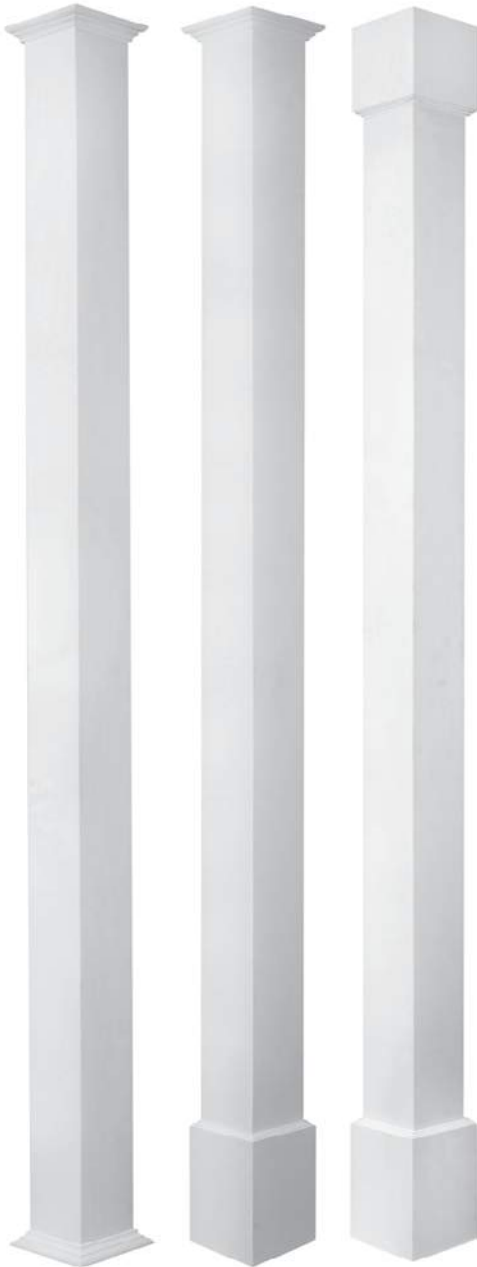

Bed Mould*

Hampton

Chesapeake

PermaSnap™ Column Wrap Technical Specifications

| Product Description | Actual Inside Dimension | Actual Outside Dimension | Column Wrap Will Fit |
|---------------------|----------------------------|----------------------------|----------------------|
| 4" x 4" x 8'-6" | 4" x 4" x 8'-6" | 4-3/4" x 4-3/4" x 8'-6" | 4" x 4" Post |
| 4" x 4" x 10'-0" | 4" x 4" x 10'-0" | 4-3/4" x 4-3/4" x 10'-0" | 4" x 4" Post |
| 6" x 6" x 8'-6" | 6" x 6" x 8'-6" | 6-3/4" x 6-3/4" x 8'-6" | 6" x 6" Post |
| 6" x 6" x 10'-0" | 6" x 6" x 10'-0" | 6-3/4" x 6-3/4" x 10'-0" | 6" x 6" Post |
| 8" x 8" x 8'-6" | 8-3/4" x 8-3/4" x 8'-6" | 9-1/2" x 9-1/2" x 8'-6" | 8" x 8" Post |
| 8" x 8" x 10'-0" | 8-3/4" x 8-3/4" x 10'-0" | 9-1/2" x 9-1/2" x 10'-0" | 8" x 8" Post |
| 10" x 10" x 8'-6" | 10-3/4" x 10-3/4" x 8'-6" | 11-1/2" x 11-1/2" x 8'-6" | 10" x 10" Post |
| 10" x 10" x 10'-0" | 10-3/4" x 10-3/4" x 10'-0" | 11-1/2" x 11-1/2" x 10'-0" | 10" x 10" Post |

*There may be a variance of up to 1/8" in all dimensions.

PermaSnap™ Accessories

| Accessories | Sizes Available |
|----------------------|------------------|
| Bed Mould Trim Kit* | 4, 6, 8, and 10" |
| Hampton Trim Kit | 4, 6, 8, and 10" |
| Chesapeake Trim Kit | 4, 6, 8, and 10" |
| Bed Mould XL | 4, 6, 8, and 10" |
| Neck Mould | 4, 6, 8, and 10" |
| Charleston Newel Cap | 4" |
| Wilmington Newel Cap | 4" |
| Ashbury Newel Cap | 6" |

*Bed Mould Trim Kit is needed for both ends
NOTE: Accessories sold separately.



Charleston 4" Newel Cap



Wilmington 4" Newel Cap



Ashbury 6" Newel Cap





ARCHITECTURAL COLUMNS

We offer columns ranging from the timeless architectural orders to more modern no-taper rounds, squares (plain and panel), craftsman, colonial, and barrel columns. Columns are available in paint grade woods (finger-jointed pine, redwood, or cedar) for interior or exterior use or stain grade woods for interior applications (most common stain grade species are shown below). We recommend using western red cedar or heart redwood for exterior applications due to their superior natural weather-resistant characteristics. We can factory prime columns to be painted and apply coating for added protection for columns to be installed outside.

| SHAFT SPECIFICATIONS FOR TUSCAN, ROMAN IONIC, ROMAN DORIC, AND ROMAN CORINTHIAN COLUMNS | | | | |
|---|---------------------|---------------------|--------|----------|
| Shaft Nominal Diameter | Bottom | Top | Flutes | |
| | Net Inside Diameter | Net Inside Diameter | Number | Width |
| 6" | 3" | 2 1/2" | 24 | 1/2" |
| 8" | 5 1/4" | 4 3/8" | 24 | 1 1/16" |
| 10" | 7 1/4" | 6 3/8" | 24 | 7/8" |
| 12" | 9" | 7 3/4" | 24 | 1" |
| 14" | 10 1/8" | 9" | 24 | 1 1/4" |
| 16" | 12" | 10" | 24 | 1 1/4" |
| 18" | 14 1/4" | 12" | 24 | 1 1/2" |
| 20" | 16 1/4" | 13" | 24 | 1 11/16" |
| 22" | 18 1/4" | 15" | 24 | 1 5/16" |
| 24" | 20 1/4" | 17" | 24 | 2 1/8" |
| 26" | 22 1/8" | 19" | 24 | 2 1/4" |
| 28" | 24 1/8" | 21" | 24 | 2 11/16" |

THE CLASSIC COLUMNS

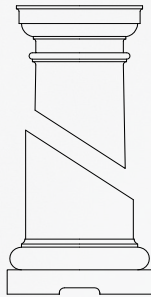

Tuscan

- Simplest and strongest design
- Usually Plain rather than fluted
- Shaft length, including cap and base, is seven times diameter.

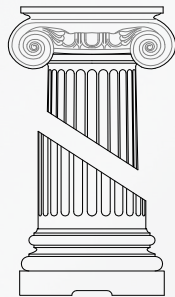

Roman Ionic

- Ornate design with decorative scrolled capital and Attic Base
- Contains 24 semi-circular flutes separated by fillets
- Shaft length, including cap and base, is nine times diameter.

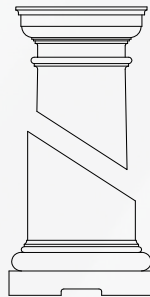

Roman Doric

- Next in strength and simplicity to the Tuscan cap and base contain additional moulding detail
- Usually Plain rather than fluted
- Shaft length, including cap and base, is eight times diameter.

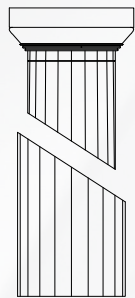

Greek Doric

- Has no base
- Contains 20 shallow flutes that form peaks (no fillets)
- Shaft length, including cap, is five and a half times diameter.

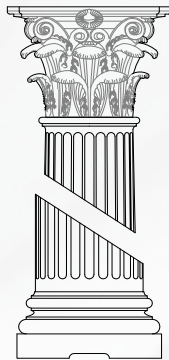

Roman Corinthian

- Most elegant style, features an inverted bell capital adorned with acanthus leaves and an Attic Base
- Fluted in the Ionic Style
- Shaft length, including cap and base, is ten times diameter.

MOST POPULAR STAIN GRADE WOOD SPECIES



Redwood



Ponderosa Pine



Mahogany



Cherry



Maple



Poplar



Walnut



Oak

FLUTE OPTIONS

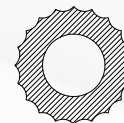

Greek Doric

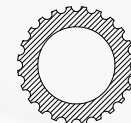

Roman Ionic

CUSTOM SPLITTING OPTIONS



Q



C



D



H



K



ROUND WOOD COLUMNS

COLUMN DIMENSIONS (IN INCHES)

| COL. SIZE | A | B | C | D | E | F | G | J | K | L | O | N | R | T | LENGTHS AVAIL (ft) |
|-----------|---------|--------|---------|--------|--------|-------|---------|--------|---------|---------|--------|----|---------|----|--------------------|
| 6" | 5 5/8" | 4 3/8" | 7 1/4" | 1 3/8" | 1 1/4" | 3/16" | 1 5/16" | 1 1/8" | 1 1/16" | 7" | 4 1/2" | 8" | 3 7/16" | 2" | 8,10 |
| 8" | 7" | 6 1/4" | 9 1/4" | 1 1/2" | 1 1/4" | 3/4" | 1 5/16" | 1 1/4" | 1 1/4" | 8 3/8" | 4 1/2" | 8" | 3 3/4" | 2" | 8,10,12 |
| 10" | 9" | 8 1/4" | 11 1/4" | 1 1/2" | 1 1/4" | 3/4" | 1 5/16" | 1 1/4" | 1 1/16" | 10 1/2" | 4 1/2" | 8" | 3 3/4" | 2" | 8,10,12 |
| 12" | 11 1/8" | 9 3/8" | 13 3/8" | 1 3/8" | 1 1/4" | 7/8" | 1 5/16" | 1 1/4" | 1 1/8" | 12" | 4 1/2" | 8" | 3 3/8" | 2" | 8, 10, 12 |

Larger sizes available. Call for quote.

ROUND WOOD INSIDE DIMENSIONS

Inside diameter may vary up to 1/4".
Splitting a column will decrease inside dimension 1/8".

| COL. DIA. | TOP I.D. | BOT I.D. |
|-----------|----------|----------|
| 6" | 3 1/8" | 3 1/8" |
| 8" | 4 3/8" | 4 3/8" |
| 10" | 6 3/4" | 6 1/4" |
| 12" | 7 1/8" | 9 3/8" |

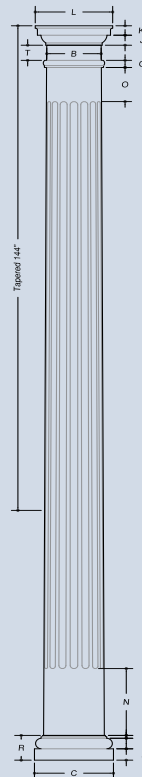
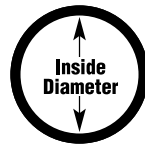

CAPITALS AND BASES FOR WOOD COLUMNS

CAPITAL DIMENSIONS FOR ROUND COLUMNS (IN INCHES)

| Size of Columns (Diameter at bottom of shaft) | | 8" | 10" | 12" |
|--|------------|----------|-----------|-----------|
| Roman Ionic | Height | 3 15/16" | 4" | 4 5/8" |
| | Abacus | 8 1/8" | 10 3/4" | 12 1/2" |
| | Projection | 3 1/8" | 4 1/8" | 5" |
| | O/S to O/S | 10 1/2" | 13 3/16" | 16 1/2" |
| Greek Ionic | Height | 4 1/8" | 5 5/8" | 6 9/16" |
| | Abacus | 7 15/16" | 10 11/16" | 14 3/8" |
| | Projection | 3 5/8" | 5" | 7 1/2" |
| | O/S to O/S | 11 7/8" | 14 15/16" | 20 11/16" |
| Temple of the Winds | Height | 8" | 10 5/16" | 11 5/8" |
| | Abacus | 11 7/8" | 13 7/16" | 16 9/16" |
| | Projection | 5 1/2" | 6" | 7" |
| | O/S to O/S | 11 7/8" | 13 7/16" | 16 9/16" |
| Roman Corinthian | Height | 8 11/16" | 11 15/16" | 14 5/8" |
| | Abacus | 12 1/16" | 14 3/8" | 18 7/8" |
| | Projection | 4 1/4" | 6 1/4" | 8 1/4" |
| | O/S to O/S | 12 1/16" | 14 3/8" | 18 7/8" |
| Samozi | Height | 3 1/8" | 4 1/8" | 5 1/16" |
| | Abacus | 9 7/8" | 14 1/4" | 16 3/8" |
| | Projection | 3 3/8" | 5 3/8" | 6" |
| | O/S to O/S | 10" | 14 1/4" | 16 5/8" |

8" - 12" LOAD BEARING ORNAMENTAL CAPITALS FOR ROUND WOOD COLUMNS

Adding a load bearing ornamental capital to a round wood column will lengthen or shorten the overall height of the column depending on the height of the capital. Subtract the "T" dimension (from the column dimensions chart) and add the height of the ornamental capital +/- 1/4" for overall column height.

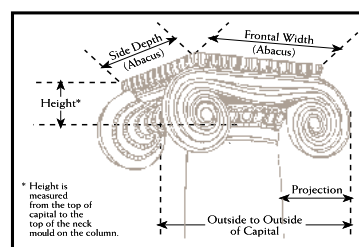
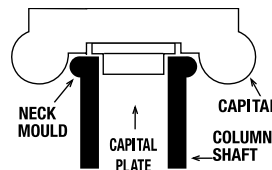

• 8"-12" Round Ornamental Capitals are load bearing.

CAPITAL AND BASE OPTIONS

The same cap and base profiles offered in PermaCast® are also available for wood.

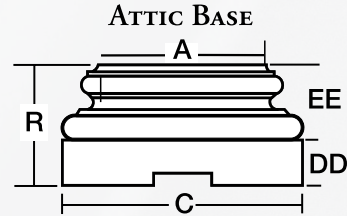

For columns 8" to 12" in diameter, bases, including plinth, are Polyurethane.

| COLUMN SIZE | BOTTOM DIA. (NET) | ROUND BASE | | | |
|-------------|-------------------|------------|--------|--------|--------|
| | | A | C | DD | EE |
| 6"* | CALL | CALL | CALL | CALL | CALL |
| 8" | 8 1/8" | 10 1/4" | 1 7/8" | 3 1/4" | 5 1/8" |
| 10" | 9 5/8" | 13" | 2 1/2" | 4" | 6 1/2" |
| 12" | 11 5/8" | 16" | 2 7/8" | 4 5/8" | 7 1/2" |

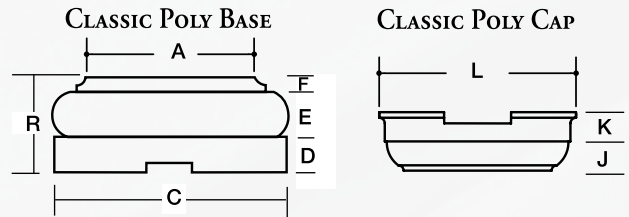

CLASSIC POLY CAP AND BASE DIMENSIONS

| BASE | A | C | D | E | F | R | CAP | J | K | L |
|------|---------|---------|---------|--------|------|---------|-----|---------|---------|---------|
| 8" | 7" | 10 1/4" | 1 7/8" | 1 3/4" | 5/8" | 4 1/4" | 8" | 1 1/16" | 1 5/16" | 8 7/8" |
| 10" | 9" | 12 7/8" | 2 7/16" | 2 1/8" | 3/4" | 5 5/16" | 10" | 1 1/4" | 1 3/4" | 10 5/8" |
| 12" | 11 5/8" | 16" | 2 7/8" | 2 3/8" | 7/8" | 6 1/8" | 12" | 1 3/4" | 2 1/16" | 13 3/4" |

CUSTOM SPLITTING OPTIONS

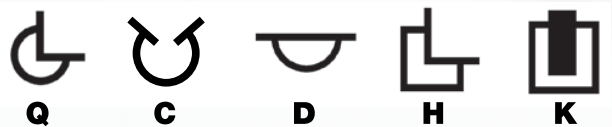

Capitals and bases for wood columns are load bearing. The shaft fits between the capital and base and alters the height of the shaft. Several options are offered for wood columns.

CLASSIC CAPITAL AND BASE

The Classic style is standard and best complements the wood column.

ORNAMENTAL CAPITALS

Five styles of ornamental capitals are available. Nothing makes a statement like wood columns with an ornamental cap. 8"-12" ornamental capitals for Round wood columns are load bearing.

Using an ornamental capital with a wood shaft will alter the height of the shaft.

ATTIC BASE

Attic bases are used for a more ornate look and comes in two pieces. (In the chart, see DD for the plinth dimension and EE for the torus dimension.)

TIPS

When ordering an ornamental cap order the appropriate base for the column.

Ornamental caps will lengthen or shorten the height of the column.

Ensure exact opening measurement prior to ordering column length.

WHAT YOU NEED TO KNOW

- The height of a column includes capital and base (Ex. 8' = shaft 7' 6 1/2" and capital and base total 8').
- Cap and base fit on top and bottom of column insulating the column from the elements.
- Split columns are not load bearing.
- For transportation purposes, small sections of split columns are left partially intact.
- Store columns in dry, well-ventilated area.
- For exterior applications: Paint inside of column shaft with a nonfibrous asphaltum type roof coating. Application must reach minimum 48" up the inside bottom of the column shaft.
- Wood columns require ventilation at the top and bottom.
- Failure to adhere to installation instructions voids the warranty.

(items are approximate scale only)

NON-STOCK
SPECIAL ORDER ITEM

Square Aluminum Columns

Heritage, Legend, and Elite Square Aluminum Columns

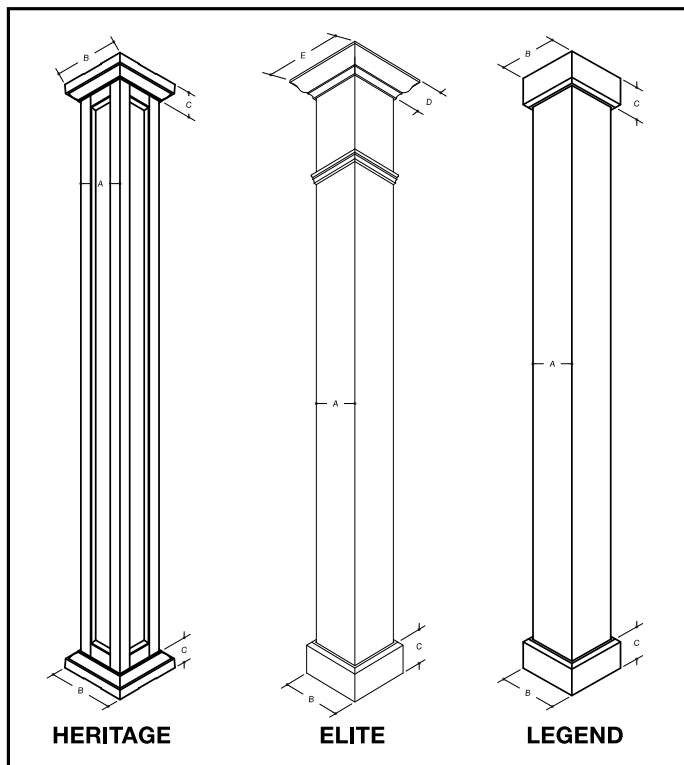

HERITAGE

ELITE

LEGEND



| WHITE RECESSED PANEL HERITAGE COLUMN | | | | |
|--------------------------------------|--------------|--------|---------|--------|
| Nominal Size | STD. Lengths | A | B | C |
| 6" | 8', 9', 10' | 5-1/2" | 8-1/2" | 2-3/4" |
| 8" | 8', 9', 10' | 7-1/2" | 10-1/2" | 2-3/4" |

| TEXTURED PLAIN ELITE COLUMN | | | | | | |
|-----------------------------|--------------|--------|--------|----|----|---------|
| Nominal Size | STD. Lengths | A | B | C | D | E |
| 6" | 8', 9', 10' | 5-1/2" | 7-1/4" | 5" | 3" | 10-1/2" |
| 8" | 8', 9', 10' | 7-1/2" | 9-1/4" | 5" | 3" | 12-1/2" |

| TEXTURED PLAIN LEGEND COLUMN | | | | |
|------------------------------|--------------|--------|--------|----|
| Nominal Size | STD. Lengths | A | B | C |
| 6" | 8', 9', 10' | 5-1/2" | 7-1/4" | 5" |
| 8" | 8', 9', 10' | 7-1/2" | 9-1/4" | 5" |

Aluminum Columns

NON-STOCK
SPECIAL ORDER ITEM

(items are approximate scale only)

TRADITIONAL SQUARE ALUMINUM COLUMNS

- Pre-Finished • Load Bearing • Low Maintenance • Available in Fluted, Recessed Panel, or Plain

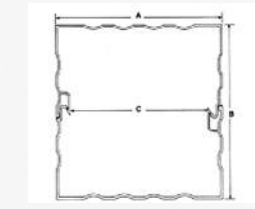
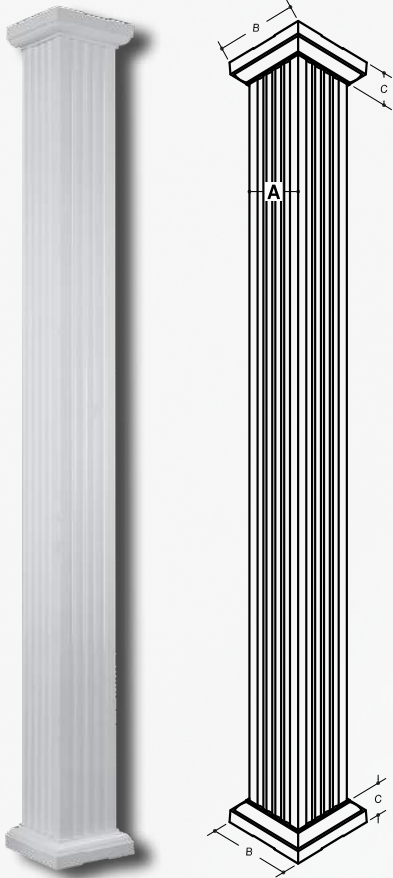

4", 6", and 8" columns have two staves each.

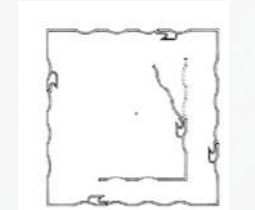

10" Columns have four staves each.

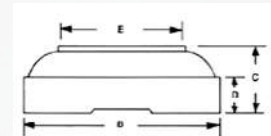

Standard Cast Aluminum Cap and Base

| WHITE SQUARE FLUTED COLUMN DIMENSIONS | | | | |
|---------------------------------------|-------------|--------|----------|--------|
| Col. Size | # of Staves | A | B | C |
| 4" | 2 | 4-1/4" | 6-1/4" | 1-7/8" |
| 6" | 2 | 5-1/2" | 8-1/4" | 2-3/4" |
| 8" | 2 | 7-1/2" | 10-3/16" | 2-3/4" |
| 10" | 4 | 9-3/8" | 12-1/4" | 3" |

| CAP AND BASE DIMENSIONS | | | | |
|-------------------------|----------|--------|----------|---------|
| Col. Size | B | C | D | E |
| 4" | 6-1/4" | 1-7/8" | 15/16" | 4-3/8" |
| 6" | 8-1/4" | 2-3/4" | 1-1/2" | 5-9/16" |
| 8" | 10-3/16" | 2-3/4" | 1-1/2" | 7-9/16" |
| 10" | 12-1/4" | 3" | 1-11/16" | 9-7/16" |

| AVAILABLE SIZES | |
|-----------------|-----------|
| 4" x 8' | 8" x 8' |
| 4" x 10' | 8" x 9' |
| 6" x 8' | 8" x 10' |
| 6" x 9' | 10" x 8' |
| 6" x 10' | 10" x 9' |
| | 10" x 10' |



WHITE FLUTED ROUND ALUMINUM COLUMN

Round fluted aluminum columns are no-taper and have been designed to provide a lifetime of structural integrity. Columns are pre-finished and load bearing.

| STANDARD CAPS AND BASES (Dimensions in inches on columns and bases) | | | | | |
|--|----------|---------|---------|----------|---------|
| Col. Dia. | A | B | C | D | E |
| 6" | 5-3/4" | 6-1/16" | 7-1/2" | 2-1/8" | 1-1/16" |
| 8" | 7-5/8" | 8" | 10" | 2-11/16" | 1-1/4" |
| 10" | 9-9/16" | 10" | 12-1/2" | 3-3/8" | 1-5/8" |
| 12" | 11-7/16" | 12" | 15" | 4" | 2" |

| DIMENSION DATA IN INCHES | | | | |
|--------------------------|--------------------------|------------------------|-------------|-------------|
| Col. Dia. | # Staves in Whole Column | # Staves in 1/2 Column | Column O.D. | Column I.D. |
| 6" | 3 | 2 | 5-3/4" | 4-15/16" |
| 8" | 3 | 2 | 7-3/4" | 7" |
| 10" | 4 | 2 | 9-9/16" | 8-3/4" |
| 12" | 5 | 3 | 11-7/16" | 10-5/8" |

| AVAILABLE SIZES |
|-----------------|
| 6" x 8' |
| 6" x 9' |
| 6" x 10' |
| 8" x 8' |
| 8" x 9' |
| 8" x 10' |
| 10" x 8' |
| 10" x 9' |
| 10" x 10' |
| 12" x 8' |
| 12" x 9' |
| 12" x 10' |
| 12" x 12' |

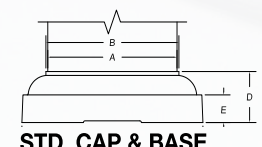
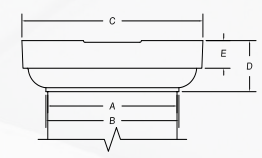

STD. CAP & BASE



(items are approximate scale only)

NON-STOCK
SPECIAL ORDER ITEM

PermaPosts® / Perma Lamp Posts

The Square PermaPost® is made from low maintenance PVC and is pre-finished with a white capstock. HB&G's Colonial and Chamfered PermaPost® are made from a low maintenance polyethylene and are pre-finished

white. For a warm and inviting decorative look for your front porch, choose from either the 5" or 6" Colonial PermaPost®, the 5" Square PermaPost®, or the 6" Chamfered PermaPost®.

PermaPosts®

Perma Lamp Posts

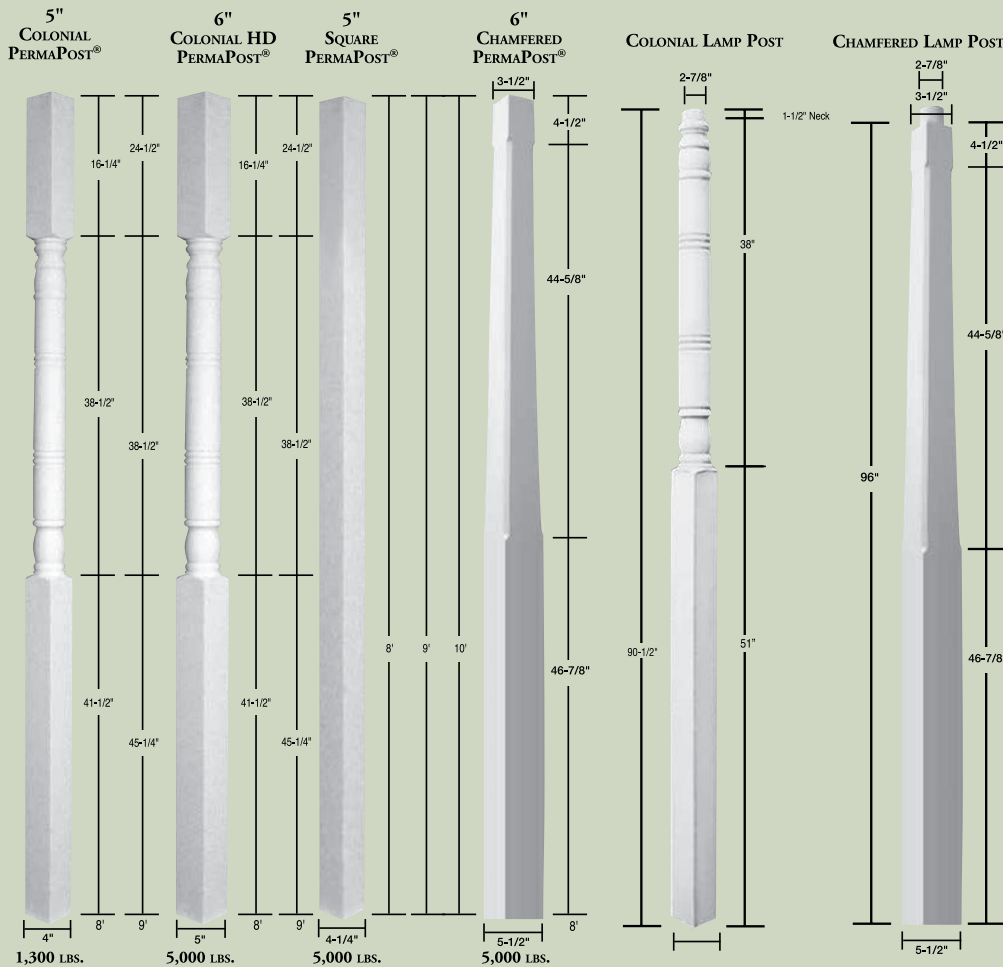

The Perma Lamp Post is an attractive way to light a drive or garden area. The pipe in the center is designed to allow a wire to be easily installed. The 2-7/8" pipe fits most outdoor lamp fixtures. New pre-finished injection molded skirts will be available in the spring.

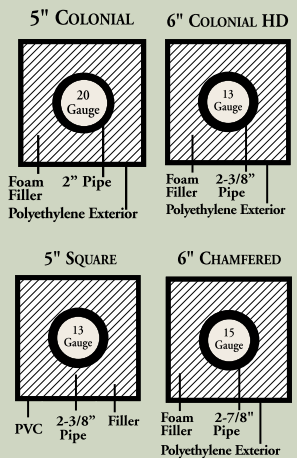

Porch-Loc™

- Adds wind uplift resistance
- Porch-Loc™ secures structural Colonial and Square PermaPost® to floor and beam/header
- Easy installation
- Durable skirts included

AVAILABLE IN 3 SIZES

| SIZE | Dimension |
|-------------|-----------|
| 5" Colonial | 4" |
| 6" Colonial | 5" |
| 5" Square | 4-1/4" |

Skirts and hardware included



Description

Dimensions are nominal and may vary slightly.

- 5" Colonial PermaPosts® and Perma Lamp Posts are net 4".
- 6" Colonial PermaPosts® are net 5".

Chamfered PermaPosts® and Perma Lamp Posts are net 3-1/2" (top) and 5-1/2" (bottom)

- Square posts are net 4-1/4".
- Perma Lamp Posts can accommodate most outdoor lamp fixtures.

New pre-finished injection molded skirts will be available in the spring.

FASTENING SYSTEMS

COLONIAL POST

Two (2) Post Fasteners are shipped with each colonial post.

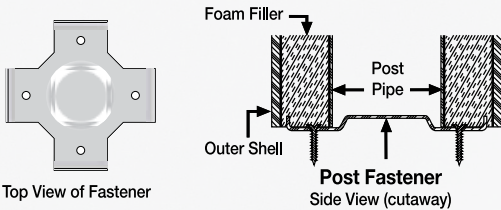

SQUARE POST

Two (2) Post Fasteners are shipped inside each post.

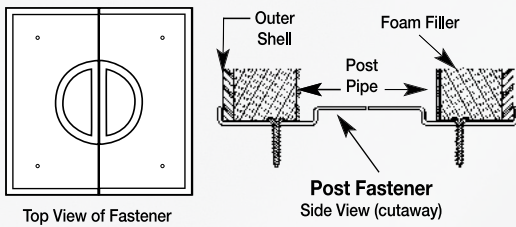

Optional Synthetic Post Fastening Kits

Each kit comes complete with skirt, brackets, and TapCon screws for wood or concrete substrates. Available for all Synthetic Post styles.

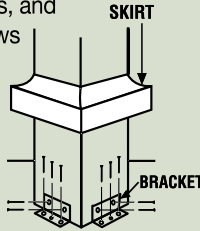

VINYL POST WRAP

NON-STOCK
SPECIAL ORDER ITEM

- Designed to Dress up a Treated Square Wood Post
- Low Maintenance
- Insect and Weather Proof
- Installs in Minutes
- Perfect for Remodeling
- Limited Lifetime Warranty
- Pre-Finished White



SIZES: 4"x 8.5', 4"x 10', 6"x 8.5', and 6"x 10'

NON-STOCK
SPECIAL ORDER ITEM

WOOD PORCH POSTS

NUMBER 100 TURNED WOOD POST

Our No. 100 turned wood posts are available in 4", 5", and 6" nominal sizes.

(Cross sections are 3-1/4", 4-1/4", and 5-1/4" net size.)

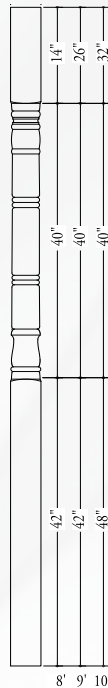

NUMBER 100
TURNED POST

ALUMINUM PLINTH FOR WOOD POST

Wood posts must be installed with aluminum plinths or quick mount bracket to comply with warranty.

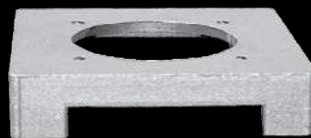

EASY INSTALLATION

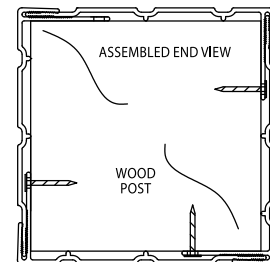

(items are approximate scale only)

PermaPost® Brackets

Brackets

NON-STOCK
SPECIAL ORDER ITEM

HB&G Polyurethane Brackets provide an inexpensive and low maintenance way to dress up your home. Choose from a wide variety of styles.

Brackets can be used with either PermaPosts® or wood posts. Enjoy a low-maintenance way to add style and decor to your front porch.



Adams

H-17¼"; W-2¾"; P-13¼"
70720



Bridgeport

H-15¼"; P-15¼"
70860



Chelsea Wood

H-13¾"; P-13"
70840



Chippendale

H-14¾"; P-14¾"
70770



Drury Lane

IN STOCK

H-12½"; P-10¼"
70890



Floral Bracket

IN STOCK

H-13¼"; P-10"
70500



Hessian

H-15¾"; P-15¾"
70820



Lady Lucille

H-13¾"; W-2½"; P-9¾"
70710



Lions Gate

IN STOCK

H-15"; P-14"
70740



Portsmouth

H-13½"; P-13½"
70810

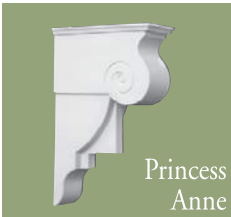

Princess Anne

H-14½"; W-4"; P-9¼"
70610

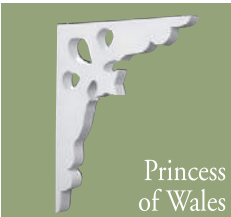

Princess of Wales

H-19"; P-15"
70520



Roanoke House

H-16"; P-9¼"
70735



Seaside Bracket

H-11 13/16"; P-11 13/16"
70750



Smithson

H-15¾"; P-15¾"
70850



Victoria

H-15"; W-4"; P-9½"
70510



Sun Rays

IN STOCK

H-12¼"; P-12¼"
70730



Townsend

IN STOCK

H-9⅞"; W-3½"; P-6¾"
70800



Trillium

H-22⅞"; P-13¼"
70790



Saint Martin

H-14 1/8"; P-12 1/8"
70550



Seaside Centerpiece

H-5⅞"; L-20½"
70760



Fleur de lis Centerpiece

H-7 1/16"; L-24"
70725



Waverly Centerpiece

H-6"; L-20"
70880



Belle Grande Centerpiece

H-5 15/16"; L-24¼"
70780



Victoria Centerpiece

H-5⅞"; W-2"; L-20"
70870



PermaPorch® Railing NON-STOCK SPECIAL ORDER ITEM

(items are approximate scale only)

The PermaPorch® Railing system is a beautiful way to tie your whole porch look together. It is made up of several different components, allowing you the ability to create the designs that match your way of life. Easy to install, this

worry free railing system will be a beautiful, low maintenance addition to your porch or deck for generations to come. Be sure to use the coastal newel in areas where coastal effect corrosion is a concern.

Porch Railing

Deck Railing

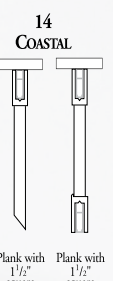
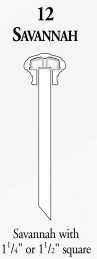
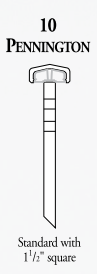
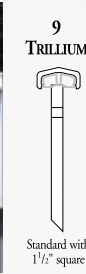
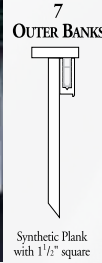
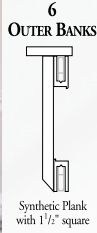
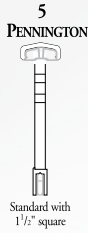
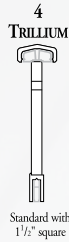

All rail sections suitable with columns (as shown) or PermaPost®
 * Top Rail Section must be installed on site.

Pre-Built PermaPorch® Railing

Pre-Built PermaPorch® Railing is available in a variety of styles to match your porch and deck design. The top and bottom rails are made of pre-finished weather resistant cellular PVC with aluminum inserts.

• HB&G recommends checking all building codes before the design and installation of your PermaPorch® Railing.



(items are approximate scale only)

NON-STOCK
SPECIAL ORDER ITEM

Rail Panels / Balusters

The top rail, bottom rail, and balusters are available in pre-finished white. They are made from weather resistant cellular PVC. The balusters are also available in round aluminum.

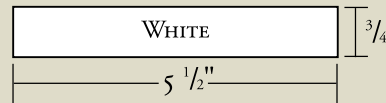
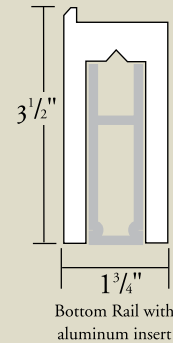
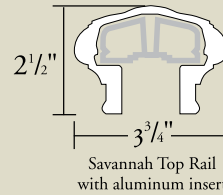
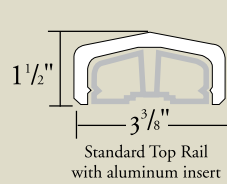

1/4"
Square
29 1/4", 32",
36" & 10'



1/2"
Square
32", 36"
& 10'



1/2"
Square
38", 44"
with 45°
end



3/8"
White
Aluminum
Baluster
28", 34"

Standard and Coastal* Square Newel
Post Mount System

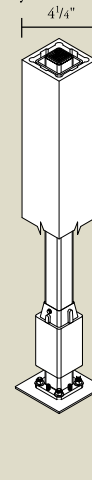
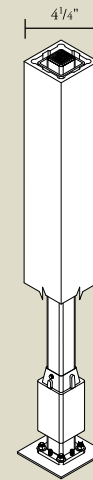

Chesterfield
Newel

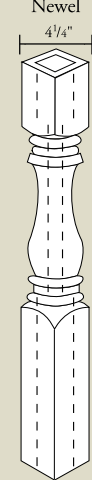

*Coastal Newel Post is designed to be used in harsh and coastal conditions.

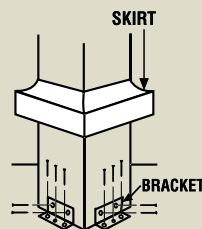

CHESTERFIELD FASTENING KIT*

Each kit comes complete with skirt, brackets, and TapCon screws for wood or concrete substrates.

*Review building code requirements prior to use.

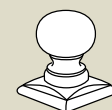

Poly Ball Top
Height 6"
Width at Base 4 1/8"

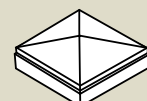

Poly Pyramid Top
Height 1 1/4"
Width at Base 4 1/8"

CUSTOM RAIL PANELS

Custom rail panels are available. Use our custom rail patterns to create a beautiful, one of a kind look that will set any home apart. HB&G's rail panels are designed to work with the PermaPorch® Railing top and bottom rails. They are made of cellular PVC and can be manufactured using your design or you can choose from one of the styles below. Contact a customer service representative now to order your custom rail panel.

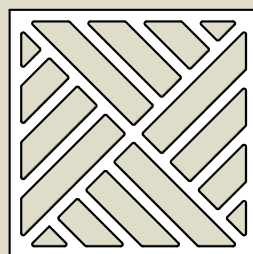

Chippendale

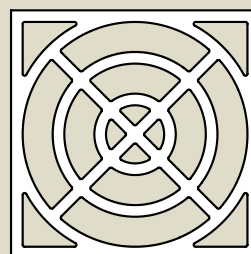

Circle Center

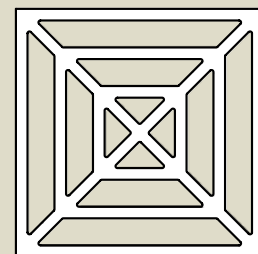

Spiderweb

Savannah PermaPorch® Railing
and 5" Square PermaPost®



Three Ways to Order the PermaPorch® Railing...

1. PRE-BUILT SECTIONS

- Shipped factory assembled
- Easy to install
- Everything needed to install is included
- How to order
 - Choose length – 4', 6', or 8' sections
 - Choose desired style from page 33 and 34
 - Note rail height (36" or 42")
- Onsite trimming ensures exact fit

2. DO-IT-YOURSELF KIT

- Rail Section shipped in one box
- Balusters are included in box*
- Everything needed to assemble and install is included
- How to order:
 - Choose length – 6' or 8'
 - Choose style – Savannah or Standard
- Kit includes:
 - Savannah or Standard top rail
 - Bottom rail
 - Aluminum inserts
 - 1 1/2" x 29 1/4" square balusters
 - 8' = 18 balusters
 - 6' = 14 balusters
 - Assembly and installation hardware
 - Support block
- Available in 36" rail height only

*Screws for balusters are not included

3. INDIVIDUAL COMPONENTS

- Build your own design
- Mix and match components
- For a complete rail system you will need the following:
 - Top rail – Standard or Savannah
 - Top insert – aluminum 8', 10', 12'
 - Balusters – 29 1/4", 32", 36", and 10' (Balusters may need to be trimmed for desired rail height.)
 - Bottom rail
 - Bottom insert – aluminum 8', 10', 12'
 - Support block
 - Fastening kit

TYPICAL ASSEMBLIES

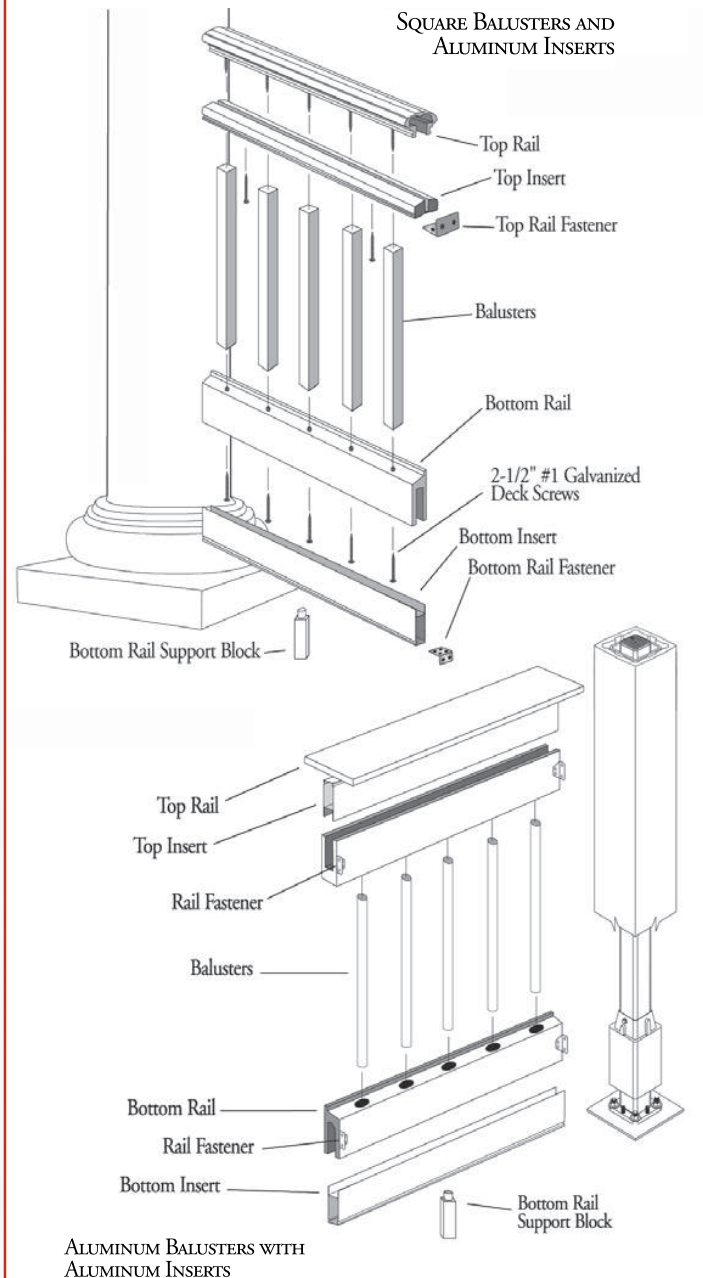

CURVED PERMAPORCH® RAILING

HB&G has a wide range of PermaPorch® Railing styles and designs. With the curved PermaPorch® Railing, HB&G's line of rail products can meet the needs of any application. The curved PermaPorch® Railing is available with either the Standard or Savannah top rail with wood inserts. Radius from 60" to 240" are available in 8 foot sections. Balusters sold separately. For lead time and ordering info, call 1-800-264-4HBG (4424).

HB&G recommends checking all building codes before the design and installation of your PermaPorch® railing.



Savannah

Standard

Big Ideas

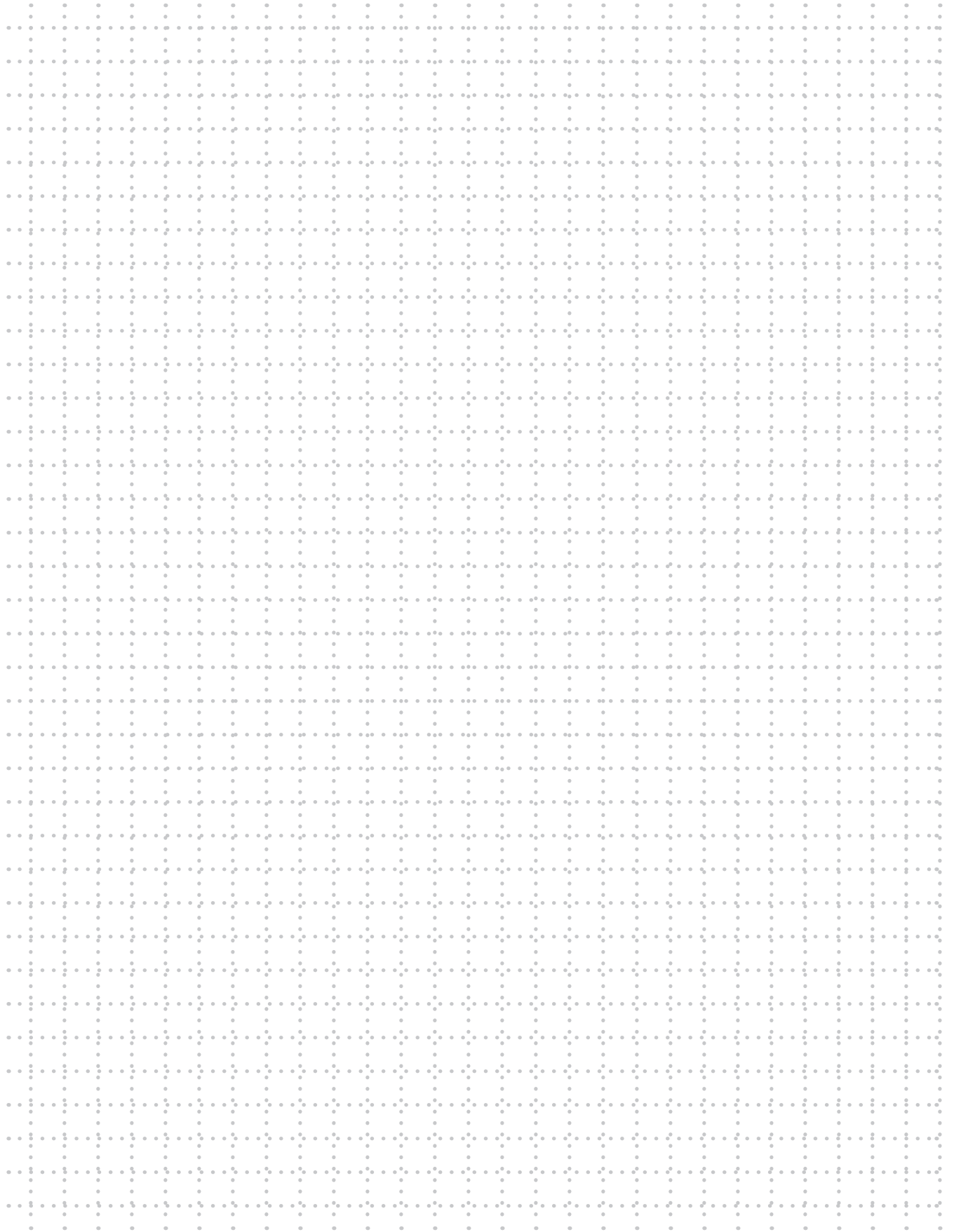

Big Ideas

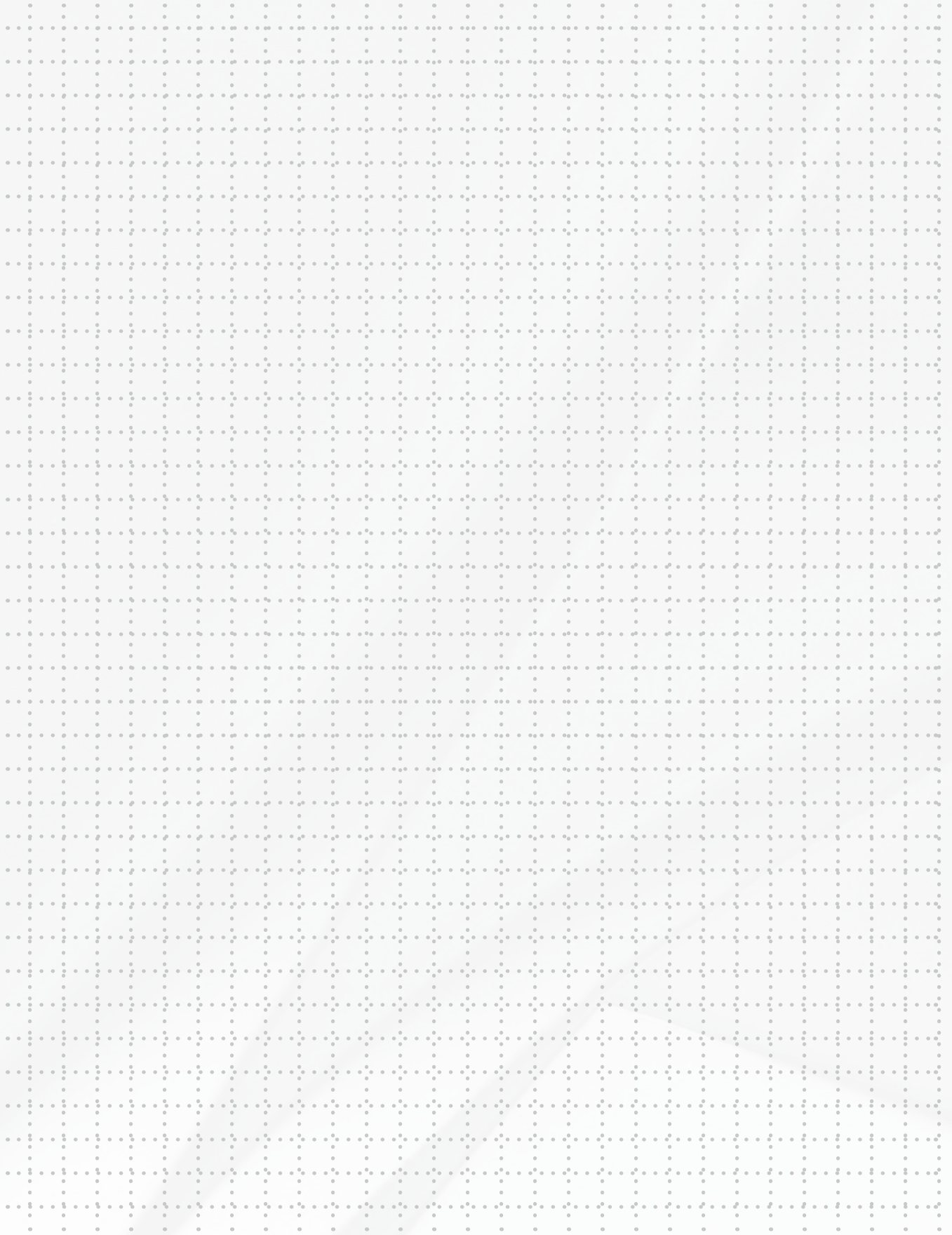

Fypon Beams & Corbels

RUSTIC BEAUTY MEETS MODERN PERFORMANCE



RUSTIC TEXTURES

Most of the products in the Rustic Collection have a texture that resembles sand-blasted cedar. The following products are exceptions. Close-ups of their textures are shown.



Milled Style Beams



Mesa Style Beams



Tahoe Style Beams

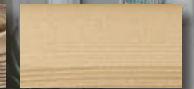

Louvers

Made of durable, high-performance polyurethane with an authentic wood grain texture, the Rustic Collection combines the look of real wood with the durability of urethane. From shutters to corbels to rafter tails and beams, you'll create a distinctive look that can weather the elements. The real beauty is that the Rustic Collection resists warping, splitting, moisture and insect infestation.

section contents

RUSTIC COLLECTION:

| | |
|----------------------------|----|
| Beams | 49 |
| Beam-Plates & Straps | 55 |
| Brackets | 75 |
| Crossheads | 87 |
| Corbels | 78 |
| Knee Braces | 77 |
| Rafter Tails | 84 |
| Shutters | 58 |
| Shutter Accessories | 71 |
| Straps | 55 |
| Window & Door Trim | 86 |

SMOOTH POLYURETHANE:

| | |
|--------------------------|----|
| Ceiling Medallions | 90 |
| Corbels | 88 |
| Crown | 89 |
| Louvers | 88 |
| Pilasters | 88 |

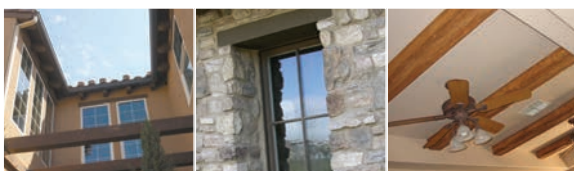

Fypon Beams & Corbels

I/E

DESIGN STYLES

TRADITIONAL | RUSTIC | SOUTHWEST

**JANKA
HARDNESS**
(POUNDS-FORCE)

N/A

INSTALLING & FINISHING POLYURETHANE

Fastening

- 1 Proper fastening is important in limiting the effects of expansion and contraction on the product.
- 2 Power nailers work well with this product but should be adjusted to prevent over driving the fastener into the material. This will prevent excessive nail pressure which can result in cracking.

Painting

Fypon products may be painted with any good quality latex paint. Usually one coat is all that is needed. They are also suitable for many faux finishing techniques, including sponging, feathering and antiquing.

Staining

Fypon Timber products are noted

as Woodgrain/Stainable and may be stained with a good quality, non-penetrating stain. Apply stain with a 2" natural bristle brush. Begin with a circular motion, then feather the stain in the direction of the grain. For a darker finish, apply a heavy coat of stain with light pressure. For a lighter finish, apply a thin coat of stain with more pressure.

Expansion & Contraction

- 1 This product expands and contracts with changes in temperature. To minimize this characteristic the recommendations given in the Fastening section should be followed.
- 2 When installing this product allow 3/16" per 18' for expansion and contraction. It is recommended that all joints be glued and where possible, fastened to the substrate to prevent joint separation.

INSTALLING & FINISHING PVC

Installing

- 1 Each piece has a consistent quality and finish, which requires no sanding, priming or sealing.
- 2 Joints between boards and sheets can easily be bonded with Devcon TrimBonder adhesive to prevent separation of joints.

Density is similar to hickory or white pine with a consistent core good for routing and can be cut and routed with standard woodworking tools.

Painting

The surface has a consistent quality and finish that never needs painting - no sanding, priming or sealing. These products may be painted to achieve desired color but is not required. Since PVC is a thermoplastic polymer, it must be painted with a paint that has a Light Reflectance Value (LRV) of 55% or higher.

There are many special formulated paint systems that will allow dark paint colors to be applied to PVC with low heat absorption.

Contact your local paint supplier for more details on painting specifications for PVC surfaces.

ALWAYS TEST TO MAKE SURE YOUR MEASURING TOOLS ARE ACCURATE. IF YOU ARE WORKING WITH A HELPER, TAKE A MEASUREMENT WITH ONE TOOL WHILE YOUR HELPER MEASURES WITH ANOTHER AND COMPARE YOUR RESULTS.

HELPFUL HINTS

- * Fypon products can be **cut, drilled or routed** similar to wood products.
- * For best results, always use **non-corrosive finish nails or screws** in combination with urethane compatible Adhesive or equivalent product.
- * **Proper Adhesive** should be applied to all contact points, including joint ends.
- * Polyurethane millwork should be **stored on a flat, level surface** in a cool, shaded area, and should not be stored in extreme heat.
- * Millwork that has been stored in a hot place should be **allowed to acclimate** to the installation area. Due to urethane's high insulating value, this may take up to 10 hours.
- * Urethane and PVC complement each other and can be easily used together. They both have similar performance benefits in that they **won't split, chip, or flake**.
- * Fypon's PVC products have a **core density between 32 - 43** pounds per cubic foot, similar to hickory, and have the same working characteristics as white pine.
- * Urethane has a **core density of 10 - 22** pounds per cubic foot, similar to that of white pine, and our process provides a greater skin density than core density.



QUICKRAIL PRODUCTS SHOULD NEVER BE PAINTED. TO DO SO WILL VOID THE LIMITED LIFETIME WARRANTY.



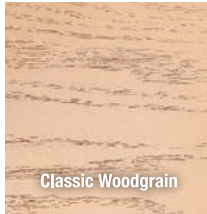

Classic Woodgrain



Milled Style



Standard Woodgrain



Tahoe Style



Rough Sawn Style

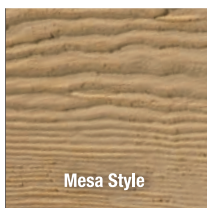

Mesa Style



Hand Hewn Style



Stone

FYPON

Where style meets performance

Style + Performance + Service = The Fypon Advantage

Fypon gives design and construction professionals an edge over all other interior and exterior design building materials. Fypon marries style and performance with one of the industry's largest product offerings and best customer service to give our customers a true competitive edge.

FYPON STYLE

Fypon is the recognized leader in polyurethane product design, innovation and molding technology. From old world style to classic modern design, Fypon offers the largest and most architecturally correct collection of styles and designs for moulding and trim, and now shutters and beams.

- Architecturally correct and historically accurate product styles and designs
- Molded from actual timber and stone products to capture the texture, patterns and deep shadow lines of classic building materials
- A distinctive look and personality to complement any home design for maximum appeal

FYPON PERFORMANCE

Only Fypon engineers consistent quality and long lasting performance into every product we make, today and tomorrow. From our popular trim and mouldings to our growing shutter and beam offerings, each product is manufactured by experts in polyurethane molding technology. All Fypon building products:

- Are easy to install with no special tools or extra labor necessary
- Deliver consistent workmanship and product quality
- Feature low maintenance
- Provide weather and moisture resistance
- Come stain or paint ready
- Resist insects and won't warp, crack or split

FYPON SERVICE

From one leader to another, building professionals trust Fypon to deliver on the jobsite and to the bottom line.

- Fypon provides architects and builders with renderings and marketing support for blue prints and model homes
- Receive extensive builder support, including an industry-first quote package program with quantity pricing tools available at CPS@fypon.com
- We provide installation FAQs (frequently asked questions) and support from master craftsmen
- Plus custom design services for historical restorations, replicas or any unique profile that fits your home or commercial application, available at CPS@fypon.com

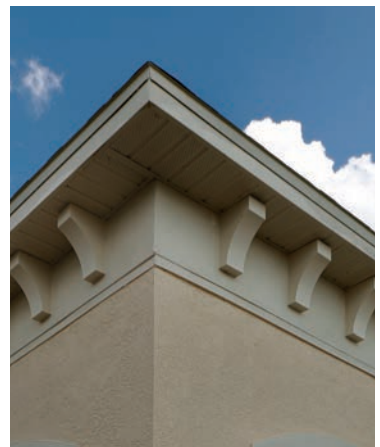
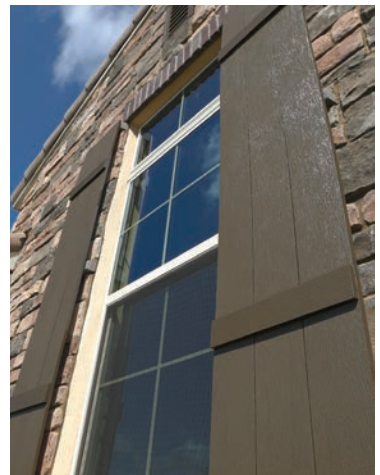

Beams

BEAMS



* Installed truss system can be viewed at M/I Homes of Houston, McKenzie Park Model at 4922 Tres Lagos Drive - <http://www.mihomes.com/McKenzieTrusses>.



(items are approximate scale only)

Beams - Mesa

Beam - Mesa Redwood



| WXH Nominal Dimensions | Actual Dimensions* | Side Wall Thickness* | Inside Top Width* | Inside Bottom Width* |
|------------------------------|-----------------------|-------------------------|----------------------|-------------------------|
| 4" X 6" | 3 1/2" X 5 1/2" | 3/4" | 2" | 1 5/8" |
| 6" X 8" | 5 1/2" X 7 1/2" | 3/4" | 4" | 3 1/2" |
| 8" X 10" | 7 1/2" X 9 1/2" | 3/4" | 6" | 5 3/8" |
| 10" X 15" | 9 1/8" X 14 3/4" | 3/4" | 7 5/8" | 6 5/8" |

Note: New beam inside dimensions are 1/4" wider to accommodate a standard 2" X 2", 2" X 4", 2" X 6", 2" X 8" blocking application. * +/- 1/4"

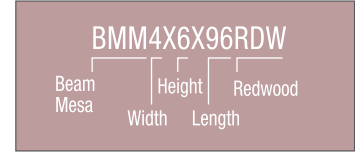

Note: Width and height are nominal, length is actual.

| 4" X 6" Part Number | 6" X 8" Part Number | 8" X 10" Part Number | 10" X 15" Part Number | Additional Sizes |
|------------------------|------------------------|-------------------------|--------------------------|---|
| BMM4X6X96RDW | BMM6X8X96RDW | BMM8X10X96RDW | BMM10X15X234RDW* | <p>Available in 24" increments, from 96" to 288"</p> |
| BMM4X6X144RDW | BMM6X8X144RDW | BMM8X10X144RDW | | |
| BMM4X6X120RDW | BMM6X8X120RDW | BMM8X10X120RDW | | |
| BMM4X6X192RDW | BMM6X8X192RDW | BMM8X10X192RDW | | |
| BMM4X6X240RDW | BMM6X8X240RDW | BMM8X10X240RDW | | |
| BMM4X6X288RDW | BMM6X8X288RDW | BMM8X10X288RDW | | |

* Only available in 234".



Parts may be required to ship LTL (less than truckload) based on size and overall dimensions.



Beams - Tahoe

(items are approximate scale only)



Beam - Tahoe

Cedar

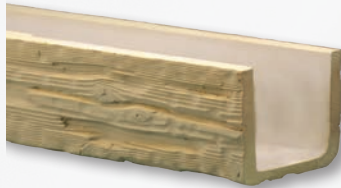

| WXH Nominal Dimensions | Actual Dimensions* | Side Wall Thickness* | Inside Top Width* | Inside Bottom Width* |
|------------------------------|-----------------------|-------------------------|----------------------|-------------------------|
| 4" X 6" | 3 1/2" X 5 1/2" | 3/4" | 2" | 1 5/8" |
| 6" X 8" | 5 1/2" X 7 1/2" | 3/4" | 4" | 3 1/2" |
| 8" X 10" | 7 1/2" X 9 1/2" | 3/4" | 6" | 5 3/8" |

Note: New beam inside dimensions are 1 1/4" wider to accommodate a standard 2" X 2", 2" X 4", 2" X 6", 2" X 8" blocking application. * +/- 1/4"

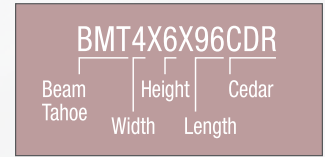

Note: Width and height are nominal, length is actual.

| 4" X 6" Part Number | 6" X 8" Part Number | 8" X 10" Part Number | Additional Sizes |
|------------------------|------------------------|-------------------------|---|
| BMT4X6X96CDR | BMT6X8X96CDR | BMT8X10X96CDR | <p>Available in 24" increments, from 96" to 288"</p> |
| BMT4X6X120CDR | BMT6X8X120CDR | BMT8X10X120CDR | |
| BMT4X6X144CDR | BMT6X8X144CDR | BMT8X10X144CDR | |
| BMT4X6X192CDR | BMT6X8X192CDR | BMT8X10X192CDR | |
| BMT4X6X240CDR | BMT6X8X240CDR | BMT8X10X240CDR | |
| BMT4X6X288CDR | BMT6X8X288CDR | BMT8X10X288CDR | |



(items are approximate scale only)

Beams - Hand Hewn

Beam - Hand Hewn Elm



| WXH Nominal Dimensions | Actual Dimensions* | Side Wall Thickness* | Inside Top Width* | Inside Bottom Width* |
|------------------------------|-----------------------|-------------------------|----------------------|-------------------------|
| 4" X 6" | 3 1/2" X 5 1/2" | 3/4" | 2" | 1 5/8" |
| 6" X 8" | 5 1/2" X 7 1/2" | 3/4" | 4" | 3 1/2" |
| 8" X 10" | 7 1/2" X 9 1/2" | 3/4" | 6" | 5 3/8" |

Note: New beam inside dimensions are 1 1/4" wider to accommodate a standard 2" X 2", 2" X 4", 2" X 6", 2" X 8" blocking application. * +/- 1/8"

BMH4X6X96ELM

Beam Hand Hewn | Height Elm
Width Length

Note: Width and height are nominal, length is actual.

| 4" X 6" Part Number | 6" X 8" Part Number | 8" X 10" Part Number | Additional Sizes |
|------------------------|------------------------|-------------------------|---|
| BMH4X6X96ELM | BMH6X8X96ELM | BMH8X10X96ELM | <p>Available in 24" increments, from 96" to 288"</p> |
| BMH4X6X120ELM | BMH6X8X120ELM | BMH8X10X120ELM | |
| BMH4X6X144ELM | BMH6X8X144ELM | BMH8X10X144ELM | |
| BMH4X6X192ELM | BMH6X8X192ELM | BMH8X10X192ELM | |
| BMH4X6X240ELM | BMH6X8X240ELM | BMH8X10X240ELM | |
| BMH4X6X288ELM | BMH6X8X288ELM | BMH8X10X288ELM | |



Parts may be required to ship LTL (less than truckload) based on size and overall dimensions.



Beams - Rough Sawn

(items are approximate scale only)



Beam - Rough Sawn

Cedar



| WXH Nominal Dimensions | Actual Dimensions* | Side Wall Thickness* | Inside Top Width* | Inside Bottom Width* |
|------------------------------|-----------------------|-------------------------|----------------------|-------------------------|
| 4" X 6" | 3 1/2" X 5 1/2" | 3/4" | 2" | 1 5/8" |
| 6" X 8" | 5 1/2" X 7 1/2" | 3/4" | 4" | 3 1/2" |
| 8" X 10" | 7 1/2" X 9 1/2" | 3/4" | 6" | 5 3/8" |

Note: New beam inside dimensions are 1 1/4" wider to accommodate a standard 2" X 2", 2" X 4", 2" X 6", 2" X 8" blocking application. * +/- 1/4"

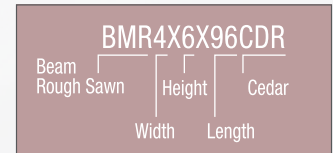

Note: Width and height are nominal, length is actual.

| 4" X 6" Part Number | 6" X 8" Part Number | 8" X 10" Part Number | Additional Sizes |
|------------------------|------------------------|-------------------------|---|
| BMR4X6X96CDR | BMR6X8X96CDR | BMR8X10X96CDR | <p>Available in 24" increments, from 96" to 288"</p> |
| BMR4X6X120CDR | BMR6X8X120CDR | BMR8X10X120CDR | |
| BMR4X6X144CDR | BMR6X8X144CDR | BMR8X10X144CDR | |
| BMR4X6X192CDR | BMR6X8X192CDR | BMR8X10X192CDR | |
| BMR4X6X240CDR | BMR6X8X240CDR | BMR8X10X240CDR | |
| BMR4X6X288CDR | BMR6X8X288CDR | BMR8X10X288CDR | |



(items are approximate scale only)

Beam Plates / Beam Straps

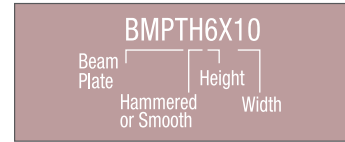

Beam Plates

| | Smooth | | Hammered | | |
|--|-------------|-------------|-------------|---|---|
| | Part Number | Part Number | Part Number | Part Number | |
| | BMPTS6X10* | BMPTH6X10* | | | |
| | BMPTS8X10* | BMPTH8X10* | | BMPTS36X36** <small>NON-STOCK SPECIAL ORDER ITEM</small> | BMPTH36X36** <small>NON-STOCK SPECIAL ORDER ITEM</small> |
| | BMPTS10X15* | BMPTH10X15* | | BMPTS48X48** <small>NON-STOCK SPECIAL ORDER ITEM</small> | BMPTH48X48** <small>NON-STOCK SPECIAL ORDER ITEM</small> |
| | BMPTS15X20* | BMPTH15X20* | | | |

*Nuts and bolts molded into beam plates, sold in packages of 2, front and back plate

**Beam plate can be cut to fit your specific project requirement.

Note: Nut and bolt heads are included (20 of each packaged separately).
Additional packs can be ordered separately (BMP LTHD WKT40 = 20 nuts and 20 bolts, BMP LTHD WKT20 = 10 nuts and 10 bolts, BMP LTHD WKT10 = 5 nuts and 5 bolts).

Beam Straps

| | Smooth | | Hammered | | |
|--|--------------|------------|--------------|-------------|----------|
| | Part Number | Beam Size | Part Number | Beam Size | |
| | BMSTRPS4X6 | 4" X 6" | | | |
| | BMSTRPS6X8 | 6" X 8" | | BMSTRPH4X6 | 4" X 6" |
| | BMSTRPS8X10 | 8" X 10" | | BMSTRPH6X8 | 6" X 8" |
| | BMSTRPS10X15 | 10" X 15"* | | BMSTRPH8X10 | 8" X 10" |
| | | | BMSTRPH10X15 | 10" X 15"* | |

Note: Width of beam strap is 6" for all beam sizes.

* Mesa only.



Parts may be required to ship LTL (less than truckload) based on size and overall dimensions.



Beams - Classic

(items are approximate scale only)



Beam - Classic

Smooth Cedar

| | Part Number | Overall Width | Overall Height | Length | Inside Width | Inside Height |
|---|---|---------------|----------------|--------|--------------|---------------|
|  | BM4X5X192S <small>NON-STOCK SPECIAL ORDER ITEM</small> | 6 5/8" | 5" | 16' | 2 3/4" | 4 1/4" |

Note: For smooth beam options, please refer to smooth catalog.

(items are approximate scale only)

Beams - Milled

Beam - Milled *Smooth Cedar*

| | Part Number | Overall Width | Overall Height | Length | Inside Width | Inside Height |
|---|--|---------------|----------------|--------|--------------|---------------|
|  | BMCDR4X3X168S <small>NON-STOCK SPECIAL ORDER ITEM</small> | 3 1/2" | 2 1/2" | 14' | 2" | 1 3/4" |
| | BMCDR8X6X168S <small>NON-STOCK SPECIAL ORDER ITEM</small> | 7 1/4" | 5 3/4" | 14' | 5 3/4" | 5" |



Parts may be required to ship LTL (less than truckload) based on size and overall dimensions.



Rough Sawn Cedar Shutters

NON-STOCK
SPECIAL ORDER ITEM

ROUGH SAWN CEDAR SHUTTERS



Fypon woodgrain shutters

- Our expanded line includes multiple styles and sizes, with widths of 12", 14", 18", and 24", and heights from 24" to 120", available in 1" increments.
- Accessory line of hinges and clavos creates a distinct look for your shutters.
- Available in both board and batten and plank styles for the options you'd expect from Fypon, the style leader

BOARD & BATTEN – JOINED BOARD AND BATTEN STYLES



2 OR 3 BATTEN
Batten styles with joined boards



END BATTEN
Battens are placed at the very end of the boards



Z BATTEN
The horizontal battens, or cross Z, are placed on the front of the shutter



QUARTER ROUND
Shutters that mirror unique arch top windows



ELLIPTICAL
A shutter top that mirrors the shape of a unique elliptical window

PLANK – SPACED BOARDS CREATE VISIBILITY OF SIDING BETWEEN SHUTTER BOARDS



2 OR 3 BATTEN
Batten styles with spaced boards



Z BATTEN
The horizontal battens, or cross Z, are placed on the front of the shutter



DIAMOND
Decorative diamond shape is centered between the panels



ELLIPTICAL
A shutter top that mirrors the shape of a unique elliptical window

BOARD & BATTEN LOGIC PLANK LOGIC

SH3PC18X60RS

[Profile]
SH = Shutter

[Texture]
RS = Rough Sawn Stain or Paint

[Configuration]

| | |
|---------------------------|-----------------------------|
| 2PC = 2 Board, 2 Batten | 2PZC = 2 Board, Z Batten |
| 3PC = 3 Board, 2 Batten | 3PZC = 3 Board, Z Batten |
| 4PC = 4 Board, 2 Batten | 4PZC = 4 Board, Z Batten |
| 2P3BC = 2 Board, 3 Batten | 2PEBC = 2 Board, End Batten |
| 3P3BC = 3 Board, 3 Batten | 3PEBC = 3 Board, End Batten |
| 4P3BC = 4 Board, 3 Batten | 4PEBC = 4 Board, End Batten |

[Height] (1" increments)
24 = 24" [Minimum]
120 = 120" [Maximum]

[Width]
12 = 12"
14 = 14"
18 = 18"
24 = 24"

SH3PO18X60RS

[Profile]
SH = Shutter

[Texture]
RS = Rough Sawn Stain or Paint

[Configuration]

| | |
|--------------------------|-------------------------|
| 2PO = 2 Plank, 2 Batten | 2PZ = 2 Plank, Z Batten |
| 3PO = 3 Plank, 2 Batten | 3PZ = 3 Plank, Z Batten |
| 4PO = 4 Plank, 2 Batten | 4PZ = 4 Plank, Z Batten |
| 2P3B = 2 Plank, 3 Batten | 2PD = 2 Plank, Diamond |
| 3P3B = 3 Plank, 3 Batten | 3PD = 2 Plank, Diamond |
| 4P3B = 4 Plank, 3 Batten | 4PD = 2 Plank, Diamond |

[Height] (1" increments)
24 = 24" [Minimum]
120 = 120" [Maximum]

[Width]
12 = 12"
18 = 18"
24 = 24"

QUARTER ROUND LOGIC

SH3PHLR18X60RS

[Profile]
SH = Shutter

[Texture]
RS = Rough Sawn Stain or Paint

[Configuration]

| |
|-------------------------|
| 2PHLR = 2 Board Quarter |
| 3PHLR = 3 Board Quarter |
| 4PHLR = 4 Board Quarter |

[Height] (1" increments)
24 = 24" [Minimum]
120 = 120" [Maximum]

[Width]
12 = 12"
14 = 14"
18 = 18"
24 = 24"

Note: Minimum height for Quarter Round Shutters is double the width of the shutter.
Example: SH3PHLR18x36RS – 18" = width of shutter and 36" = height (twice the width).

12" Board & Batten Shutters

(items are approximate scale only)



Additional Sizes Available

Shutter height available in 1" increments, 24"-120", available at standard lead time. See price pages for individual part numbers.

12" Board & Batten Shutters

Rough Sawn Cedar

NON-STOCK
SPECIAL ORDER ITEM

| 2 Board, 2 Batten | | 2 Board, 3 Batten | | 2 Board, End Batten | |
|--|---------------|--|-----------------|--|-----------------|
| | Part Number | | Part Number | | Part Number |
|  | SH2PC12X24RS |  | SH2P3BC12X24RS |  | SH2PEBC12X24RS |
| | SH2PC12X36RS | | SH2P3BC12X36RS | | SH2PEBC12X36RS |
| | SH2PC12X48RS | | SH2P3BC12X48RS | | SH2PEBC12X48RS |
| | SH2PC12X60RS | | SH2P3BC12X60RS | | SH2PEBC12X60RS |
| | SH2PC12X72RS | | SH2P3BC12X72RS | | SH2PEBC12X72RS |
| | SH2PC12X84RS | | SH2P3BC12X84RS | | SH2PEBC12X84RS |
| | SH2PC12X96RS | | SH2P3BC12X96RS | | SH2PEBC12X96RS |
| | SH2PC12X108RS | | SH2P3BC12X108RS | | SH2PEBC12X108RS |
| | SH2PC12X120RS | | SH2P3BC12X120RS | | SH2PEBC12X120RS |



(items are approximate scale only)

12" Board & Batten Shutters



12" Board & Batten Shutters

Rough Sawn Cedar Continued

**NON-STOCK
SPECIAL ORDER ITEM**

2 Board, Z Batten

2 Board, Quarter Round

| | Part Number | | Part Number |
|--|----------------|--|-----------------|
| | SH2PZC12X24RS | | SH2PHLR12X24RS |
| | SH2PZC12X36RS | | SH2PHLR12X36RS |
| | SH2PZC12X48RS | | SH2PHLR12X48RS |
| | SH2PZC12X60RS | | SH2PHLR12X60RS |
| | SH2PZC12X72RS | | SH2PHLR12X72RS |
| | SH2PZC12X84RS | | SH2PHLR12X84RS |
| | SH2PZC12X96RS | | SH2PHLR12X96RS |
| | SH2PZC12X108RS | | SH2PHLR12X108RS |
| | SH2PZC12X120RS | | SH2PHLR12X120RS |

Parts may be required to ship LTL (less than truckload) based on size and overall dimensions.



14" Board & Batten Shutters

(items are approximate scale only)



Additional Sizes Available

Shutter height available in 1" increments, 24"-120", available at standard lead time. See price pages for individual part numbers.

14" Board & Batten Shutters

Rough Sawn Cedar

NON-STOCK
SPECIAL ORDER ITEM

| 3 Board, 2 Batten | | 3 Board, 3 Batten | | 3 Board, End Batten | |
|--|---------------|--|-----------------|--|-----------------|
| | Part Number | | Part Number | | Part Number |
|  | SH3PC14X24RS |  | SH3P3BC14X24RS |  | SH3PEBC14X24RS |
| | SH3PC14X36RS | | SH3P3BC14X36RS | | SH3PEBC14X36RS |
| | SH3PC14X48RS | | SH3P3BC14X48RS | | SH3PEBC14X48RS |
| | SH3PC14X60RS | | SH3P3BC14X60RS | | SH3PEBC14X60RS |
| | SH3PC14X72RS | | SH3P3BC14X72RS | | SH3PEBC14X72RS |
| | SH3PC14X84RS | | SH3P3BC14X84RS | | SH3PEBC14X84RS |
| | SH3PC14X96RS | | SH3P3BC14X96RS | | SH3PEBC14X96RS |
| | SH3PC14X108RS | | SH3P3BC14X108RS | | SH3PEBC14X108RS |
| | SH3PC14X120RS | | SH3P3BC14X120RS | | SH3PEBC14X120RS |



(items are approximate scale only)

14" Board & Batten Shutters





14" Board & Batten Shutters

Rough Sawn Cedar Continued

NON-STOCK
SPECIAL ORDER ITEM

3 Board, Z Batten

3 Board, Quarter Round

| | Part Number | | Part Number |
|---|----------------|---|-----------------|
|  | SH3PZC14X24RS |  | SH3PHLR14X36RS |
| | SH3PZC14X36RS | | SH3PHLR14X48RS |
| | SH3PZC14X48RS | | SH3PHLR14X60RS |
| | SH3PZC14X60RS | | SH3PHLR14X72RS |
| | SH3PZC14X72RS | | SH3PHLR14X84RS |
| | SH3PZC14X84RS | | SH3PHLR14X96RS |
| | SH3PZC14X96RS | | SH3PHLR14X108RS |
| | SH3PZC14X108RS | | SH3PHLR14X120RS |
| | SH3PZC14X120RS | | |

Parts may be required to ship LTL (less than truckload) based on size and overall dimensions.

18" Board & Batten Shutters

(items are approximate scale only)

Additional Sizes Available

Shutter height available in 1" increments, 24"-120", available at standard lead time. See price pages for individual part numbers.

18" Board & Batten Shutters

Rough Sawn Cedar

NON-STOCK
SPECIAL ORDER ITEM

3 Board, 2 Batten

| Part Number |
|---------------|
| SH3PC18X24RS |
| SH3PC18X36RS |
| SH3PC18X48RS |
| SH3PC18X60RS |
| SH3PC18X72RS |
| SH3PC18X84RS |
| SH3PC18X96RS |
| SH3PC18X108RS |
| SH3PC18X120RS |

3 Board, 3 Batten

| Part Number |
|-----------------|
| SH3P3BC18X24RS |
| SH3P3BC18X36RS |
| SH3P3BC18X48RS |
| SH3P3BC18X60RS |
| SH3P3BC18X72RS |
| SH3P3BC18X84RS |
| SH3P3BC18X96RS |
| SH3P3BC18X108RS |
| SH3P3BC18X120RS |

3 Board, End Batten

| Part Number |
|-----------------|
| SH3PEBC18X24RS |
| SH3PEBC18X36RS |
| SH3PEBC18X48RS |
| SH3PEBC18X60RS |
| SH3PEBC18X72RS |
| SH3PEBC18X84RS |
| SH3PEBC18X96RS |
| SH3PEBC18X108RS |
| SH3PEBC18X120RS |

3 Board, Z Batten

| Part Number |
|----------------|
| SH3PZC18X24RS |
| SH3PZC18X36RS |
| SH3PZC18X48RS |
| SH3PZC18X60RS |
| SH3PZC18X72RS |
| SH3PZC18X84RS |
| SH3PZC18X96RS |
| SH3PZC18X108RS |
| SH3PZC18X120RS |

3 Board, Quarter Round

| Part Number |
|-----------------|
| SH3PHLR18X36RS |
| SH3PHLR18X48RS |
| SH3PHLR18X60RS |
| SH3PHLR18X72RS |
| SH3PHLR18X84RS |
| SH3PHLR18X96RS |
| SH3PHLR18X108RS |
| SH3PHLR18X120RS |



(items are approximate scale only)

24" Board & Batten Shutters

Additional Sizes Available

Shutter height available in 1" increments, 24"-120", available at standard lead time. See price pages for individual part numbers.

24" Board & Batten Shutters

Rough Sawn Cedar

NON-STOCK
SPECIAL ORDER ITEM

4 Board, 2 Batten

| Part Number |
|---------------|
| SH4PC24X24RS |
| SH4PC24X36RS |
| SH4PC24X48RS |
| SH4PC24X60RS |
| SH4PC24X72RS |
| SH4PC24X84RS |
| SH4PC24X96RS |
| SH4PC24X108RS |
| SH4PC24X120RS |



4 Board, 3 Batten

| Part Number |
|-----------------|
| SH4P3BC24X24RS |
| SH4P3BC24X36RS |
| SH4P3BC24X48RS |
| SH4P3BC24X60RS |
| SH4P3BC24X72RS |
| SH4P3BC24X84RS |
| SH4P3BC24X96RS |
| SH4P3BC24X108RS |
| SH4P3BC24X120RS |



4 Board, End Batten

| Part Number |
|-----------------|
| SH4PEBC24X24RS |
| SH4PEBC24X36RS |
| SH4PEBC24X48RS |
| SH4PEBC24X60RS |
| SH4PEBC24X72RS |
| SH4PEBC24X84RS |
| SH4PEBC24X96RS |
| SH4PEBC24X108RS |
| SH4PEBC24X120RS |

4 Board, Z Batten

| Part Number |
|----------------|
| SH4PZC24X24RS |
| SH4PZC24X36RS |
| SH4PZC24X48RS |
| SH4PZC24X60RS |
| SH4PZC24X72RS |
| SH4PZC24X84RS |
| SH4PZC24X96RS |
| SH4PZC24X108RS |
| SH4PZC24X120RS |



4 Board, Quarter Round

| Part Number |
|-----------------|
| SH4PHLR24X48RS |
| SH4PHLR24X60RS |
| SH4PHLR24X72RS |
| SH4PHLR24X84RS |
| SH4PHLR24X96RS |
| SH4PHLR24X108RS |
| SH4PHLR24X120RS |



Parts may be required to ship LTL (less than truckload) based on size and overall dimensions.



12" Plank Shutters

(items are approximate scale only)



Additional Sizes Available

Shutter height available in 1" increments, 24"-120", available at standard lead time. See price pages for individual part numbers.

12" Plank Shutters

Rough Sawn Cedar



NON-STOCK
SPECIAL ORDER ITEM

| 2 Plank, 2 Batten | | 2 Plank, 3 Batten | | 2 Plank, Z Batten | |
|--|---------------|--|----------------|--|---------------|
| | Part Number | | Part Number | | Part Number |
|  | SH2P012X24RS |  | SH2P3B12X24RS |  | SH2PZ12X24RS |
| | SH2P012X36RS | | SH2P3B12X36RS | | SH2PZ12X36RS |
| | SH2P012X48RS | | SH2P3B12X48RS | | SH2PZ12X48RS |
| | SH2P012X60RS | | SH2P3B12X60RS | | SH2PZ12X60RS |
| | SH2P012X72RS | | SH2P3B12X72RS | | SH2PZ12X72RS |
| | SH2P012X84RS | | SH2P3B12X84RS | | SH2PZ12X84RS |
| | SH2P012X96RS | | SH2P3B12X96RS | | SH2PZ12X96RS |
| | SH2P012X108RS | | SH2P3B12X108RS | | SH2PZ12X108RS |
| | SH2P012X120RS | | SH2P3B12X120RS | | SH2PZ12X120RS |

18" Plank Shutters

Rough Sawn Cedar

NON-STOCK
SPECIAL ORDER ITEM

| 3 Plank, 2 Batten | | 3 Plank, 3 Batten | | 3 Plank, Z Batten | |
|---|---------------|---|----------------|---|---------------|
| | Part Number | | Part Number | | Part Number |
|  | SH3P018X24RS |  | SH3P3B18X24RS |  | SH3PZ18X24RS |
| | SH3P018X36RS | | SH3P3B18X36RS | | SH3PZ18X36RS |
| | SH3P018X48RS | | SH3P3B18X48RS | | SH3PZ18X48RS |
| | SH3P018X60RS | | SH3P3B18X60RS | | SH3PZ18X60RS |
| | SH3P018X72RS | | SH3P3B18X72RS | | SH3PZ18X72RS |
| | SH3P018X84RS | | SH3P3B18X84RS | | SH3PZ18X84RS |
| | SH3P018X96RS | | SH3P3B18X96RS | | SH3PZ18X96RS |
| | SH3P018X108RS | | SH3P3B18X108RS | | SH3PZ18X108RS |
| | SH3P018X120RS | | SH3P3B18X120RS | | SH3PZ18X120RS |

(items are approximate scale only)

24" Plank Shutters



24" Plank Shutters



Rough Sawn Cedar

NON-STOCK
SPECIAL ORDER ITEM

4 Plank, 2 Batten

4 Plank, 3 Batten

4 Plank, Z Batten

| | Part Number | | Part Number | | Part Number |
|---|---------------|---|----------------|---|---------------|
|  | SH4P024X24RS |  | SH4P3B24X24RS |  | SH4PZ24X24RS |
| | SH4P024X36RS | | SH4P3B24X36RS | | SH4PZ24X36RS |
| | SH4P024X48RS | | SH4P3B24X48RS | | SH4PZ24X48RS |
| | SH4P024X60RS | | SH4P3B24X60RS | | SH4PZ24X60RS |
| | SH4P024X72RS | | SH4P3B24X72RS | | SH4PZ24X72RS |
| | SH4P024X84RS | | SH4P3B24X84RS | | SH4PZ24X84RS |
| | SH4P024X96RS | | SH4P3B24X96RS | | SH4PZ24X96RS |
| | SH4P024X108RS | | SH4P3B24X108RS | | SH4PZ24X108RS |
| | SH4P024X120RS | | SH4P3B24X120RS | | SH4PZ24X120RS |



Elliptical Shutters - Board & Batten

(items are approximate scale only)



Additional Sizes Available

Shutter height available in 1" increments, 24"-120", available at standard lead time. See price pages for individual part numbers.

Elliptical Shutters - Board & Batten

Rough Sawn Cedar

NON-STOCK
SPECIAL ORDER ITEM

ELLIPTICAL BOARD & BATTEN LOGIC



SH3PEHLR18X50X54RS

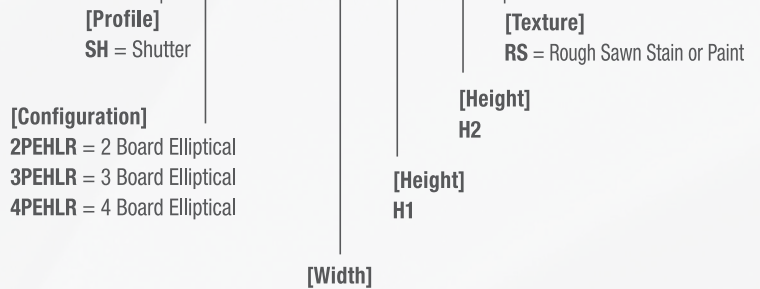

Note: If a specific radius is required to complement an elliptical shaped window, contact your customer service representative to order.

To order an elliptical shutter that complements the arch of the window, provide measurements of **H1** (in 1/4" increments) and **H2** (in 1" increments) in your part number. See drawing for specific measurement points.

Example:
SH3PEHLR18X50X56RS

W H1 H2

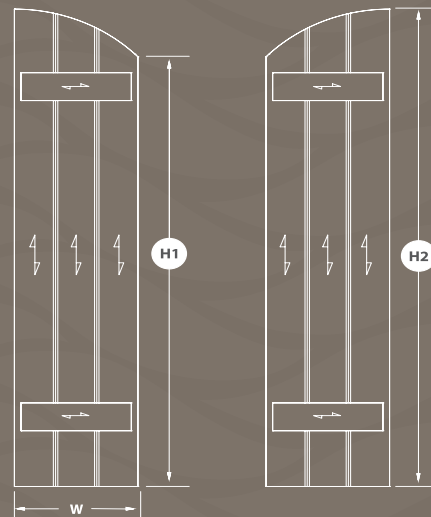

(items are approximate scale only)

Elliptical Shutters - Plank



Elliptical Shutters - Plank

Rough Sawn Cedar

NON-STOCK
SPECIAL ORDER ITEM

ELLIPTICAL PLANK LOGIC



SH3PE18X50X56RS

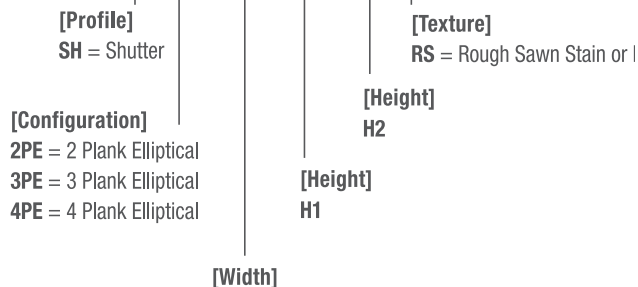

Note: If a specific radius is required to complement an elliptical shaped window, contact your customer service representative to order.

To order an elliptical shutter that complements the arch of the window, provide measurements of **H1** (in 1/4" increments) and **H2** (in 1" increments) in your part number. See drawing for specific measurement points.

Example:
SH3PE18X50X56RS

W H1 H2

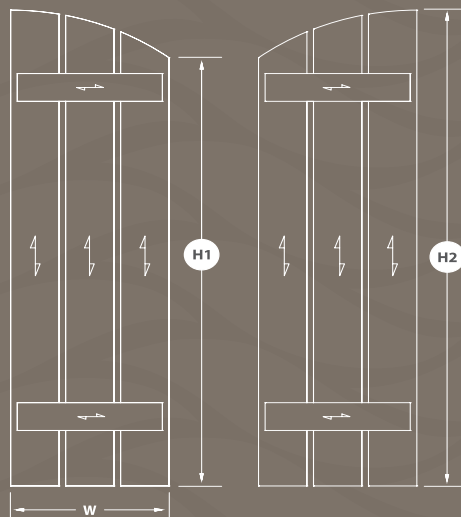

Diamond Plank Shutters

(items are approximate scale only)



Additional Sizes Available

Shutter height available in 1" increments, 24"-120", available at standard lead time. See price pages for individual part numbers.

Diamond Plank Shutters



Rough Sawn Cedar

NON-STOCK
SPECIAL ORDER ITEM

2 Plank, Diamond

3 Plank, Diamond

4 Plank, Diamond

| 2 Plank, Diamond | | 3 Plank, Diamond | | 4 Plank, Diamond | |
|---|---------------|---|---------------|---|---------------|
| | Part Number | | Part Number | | Part Number |
|  | SH2PD12X24RS |  | SH3PD18X24RS |  | SH4PD24X24RS |
| | SH2PD12X36RS | | SH3PD18X36RS | | SH4PD24X36RS |
| | SH2PD12X48RS | | SH3PD18X48RS | | SH4PD24X48RS |
| | SH2PD12X60RS | | SH3PD18X60RS | | SH4PD24X60RS |
| | SH2PD12X72RS | | SH3PD18X72RS | | SH4PD24X72RS |
| | SH2PD12X84RS | | SH3PD18X84RS | | SH4PD24X84RS |
| | SH2PD12X96RS | | SH3PD18X96RS | | SH4PD24X96RS |
| | SH2PD12X108RS | | SH3PD18X108RS | | SH4PD24X108RS |
| SH2PD12X120RS | SH3PD18X120RS | SH4PD24X120RS | | | |





(items are approximate scale only)

Shutters Accessories - Hinges / Clavos

Shutters Accessories - Hinges

NON-STOCK
SPECIAL ORDER ITEM

Colonial & Spear

| | Part Number | Length | | Part Number | Length |
|---|-------------|--------|--|-------------|--------|
|  | SHHNGCOL10* | 10" |  | SHHNGSPR10* | 10" |
| | SHHNGCOL16* | 16" | | SHHNGSPR16* | 16" |

* Sold in packs of 2.

Shutters Accessories - Clavos

NON-STOCK
SPECIAL ORDER ITEM

Round & Pyramid

| | Part Number | Diameter | | Part Number | Width |
|---|-------------------------|----------|---|-------------------------|--------|
|  | SHCLARND1.25* | 1 1/4" |  | SHCLAPYR1.25* | 1 1/4" |
| | SHCLARND1.25 - 8 pack | 1 1/4" | | SHCLAPYR1.25 - 8 pack | 1 1/4" |
| | SHCLARND1.25 - 12 pack | 1 1/4" | | SHCLAPYR1.25 - 12 pack | 1 1/4" |
| | SHCLARND1.25 - 18 pack | 1 1/4" | | SHCLAPYR1.25 - 18 pack | 1 1/4" |
| | SHCLARND1.25 - 24 pack | 1 1/4" | | SHCLAPYR1.25 - 24 pack | 1 1/4" |
| | SHCLARND1.25 - 100 pack | 1 1/4" | | SHCLAPYR1.25 - 100 pack | 1 1/4" |

* Sold in packs of 2.



Parts may be required to ship LTL (less than truckload) based on size and overall dimensions.

Shutter Board Fabrication Panels

(items are approximate scale only)

Shutter Board Fabrication Panels

Rough Sawn Cedar

**NON-STOCK
SPECIAL ORDER ITEM**

| | Individual Sheet Part Number | Width | Length | Thickness | Contractor Pack Part Number |
|---|---------------------------------|--------|--------|-----------|---|
|  | SHBB12X144RS 2-Board Panel | 12" | 144" | 3/4" | SHBB12X144RS-CP Contractor Packs sold in packs of 10 |
|  | SHBB14X144RS 3-Board Panel | 14" | 144" | 3/4" | SHBB14X144RS-CP Contractor Packs sold in packs of 10 |
|  | SHBB18X144RS 3-Board Panel | 18 " | 144" | 3/4" | SHBB18X144RS-CP Contractor Packs sold in packs of 10 |
|  | SHBB24X144RS 4-Board Panel | 24" | 144" | 3/4" | SHBB24X144RS-CP Contractor Packs sold in packs of 10 |
|  | FLT1X4-12RS Batten Trim | 3 1/2" | 144" | 3/4" | — |



(items are approximate scale only)

Louvered Shutter / Panel Shutter



Louvered Shutter

Woodgrain with Center Rail

**NON-STOCK
SPECIAL ORDER ITEM**



| Part Number | Width | Height |
|-----------------|-------|--------|
| LVSH12X36FNCR3S | 12" | 36" |
| LVSH12X48FNCR3S | 12" | 48" |
| LVSH16X48FNCR3S | 16" | 48" |
| LVSH16X60FNCR3S | 16" | 60" |
| LVSH18X48FNCR4S | 18" | 48" |
| LVSH18X60FNCR4S | 18" | 60" |

NOTE: Sold in pairs.

Panel Shutter

Woodgrain with Border

**NON-STOCK
SPECIAL ORDER ITEM**



| Part Number | Width | Height |
|-------------|-------|--------|
| SH3PB15X46S | 15" | 46" |
| SH3PB18X40S | 18" | 40" |
| SH3PB18X66S | 18" | 66" |
| SH3PB24X54S | 24" | 54" |

NOTE: Sold in pairs.
Product image is representative of actual part.

Shutter Louvered Fabrication Panels

Woodgrain

**NON-STOCK
SPECIAL ORDER ITEM**

| Part Number | Width | Length | Thickness |
|---------------|-------|--------|-----------|
| LVSSNN32X144S | 32" | 144" | 5/8" |

NOTE: Timber louvered panels sold in individual sheets.



Brackets, Corbels & Rafter Tails









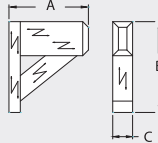

BRACKETS, CORBELS & RAFTER TAILS

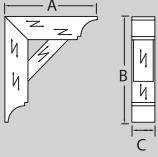

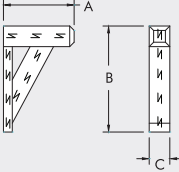
(items are approximate scale only)

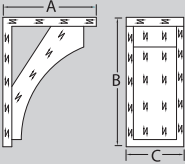
Brackets

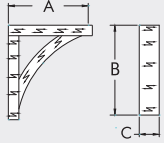

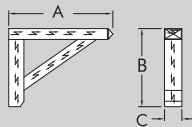
| Part Number | Projection (A) | Height (B) | Overall Width (C) | |
|---|----------------|------------|-------------------|---|
|  BKT14X16X3.5S | 14" | 16" | 3 1/2" |  |
| BKT14X16X6S | 14" | 16" | 5 1/2" | |
|  BKT22X24X4S-1 | 22" | 24" | 3 1/2" |  |
| BKT22X24X6S | 22" | 24" | 5 1/2" | |
| BKT26X24X4S | 26" | 24" | 3 1/2" | |
| BKT26X24X6S | 26" | 24" | 5 1/2" | |
|  BKT12X18X3X1S | 12" | 18" | 3 1/2" |  |
| BKT18X18X3X1S | 18" | 18" | 3 1/2" | |
|  BKT13X18X8S | 13" | 18" | 8" |  |
|  BKT16X18X4S | 16" | 18" | 4" |  |
|  BKT24X18X4S | 24" | 18" | 4" |  |

NOTE: Brackets are listed in order by height.









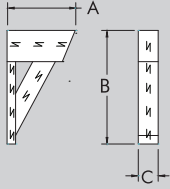

Brackets

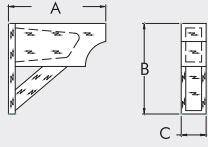
(items are approximate scale only)

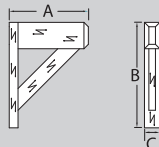
Brackets

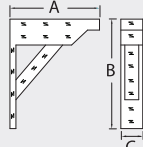
Standard Woodgrain
Continued

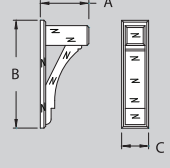
NON-STOCK
SPECIAL ORDER ITEM

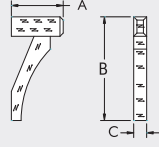
| Part Number | Projection (A) | Height (B) | Overall Width (C) | |
|--|----------------|------------|-------------------|---|
|  BKT12X20X3S | 12" | 20" | 3 1/2" |  |
|  BKT18X20X3S | 18" | 20" | 3 1/2" | |
|  BKT21X20X6S | 21 1/2" | 20" | 5 1/2" |  |
|  BKT18X24X3X2S | 18" | 24" | 3 1/2" |  |
|  BKT22.5X27.5X5.5S | 22 1/2" | 27 1/2" | 5 1/2" |  |
|  BKT14X30X7.5S | 13 1/2" | 30" | 7 1/2" |  |
|  BKT22X30X8S | 21 1/2" | 30" | 7 1/2" | |
|  BKT16X32X4S | 16" | 32" | 4" |  |



(items are approximate scale only)

Knee Braces



Knee Braces

Standard Woodgrain

| Part Number | Projection (A) | Height (B) | Overall Width (C) | |
|-------------|---|------------|-------------------|--------|
| BKT12X24X3S | 12" | 24" | 3 3/8" | |
| | BKTCV18X24X4S | 18" | 24" | 3 1/4" |
| | BKTCV18X24X6S | 18" | 24" | 5 1/4" |
| | BKTCV21X30X4S | 21" | 30" | 3 1/4" |
| | BKTCV21X30X6S | 21" | 30" | 5 1/4" |
| | | | | |
| | BKTSC18X24X3S | 18" | 24" | 3" |
| | <p>NON-STOCK SPECIAL ORDER ITEM</p> | | | |
| | BKTS18X24X6S | 18" | 24" | 5 1/2" |
| | <p>NON-STOCK SPECIAL ORDER ITEM</p> | | | |
| | BKT22X30X6S | 21 1/2" | 30" | 6" |
| | <p>NON-STOCK SPECIAL ORDER ITEM</p> | | | |

Parts may be required to ship LTL (less than truckload) based on size and overall dimensions.







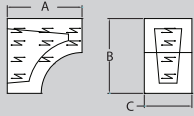

Corbels - Cove

(items are approximate scale only)

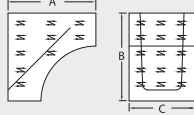
Corbels - Cove

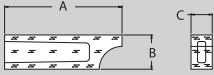
Standard Woodgrain

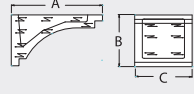
| | Part Number | Projection (A) | Height (B) | Overall Width (C) | |
|---|----------------|----------------|------------|-------------------|---|
|  <p>NON-STOCK SPECIAL ORDER ITEM</p> | COR5X5X3S* | 5 1/2" | 5 1/2" | 3 1/2" |  |
| | COR5X5S* | 5 1/2" | 5 1/2" | 5 1/2" | |
|  | COR8X8X6S* | 8" | 8" | 6" |  |
| | COR11X11X5S* | 11" | 11" | 5" | |
|  | CORCV18X6X6S* | 18" | 5 1/4" | 5 1/4" |  |
| | CORCV18X8X4S* | 18" | 7 1/4" | 3 1/4" | |
| | CORCV18X8X6S* | 18" | 7 1/4" | 5 1/4" | |
| | CORCV18X12X6S* | 18" | 11 1/4" | 5 1/4" | |
| | COR24X8X6S* | 24" | 8" | 6" | |
|  <p>NON-STOCK SPECIAL ORDER ITEM</p> | COR7X13X7S* | 13" | 7 1/4" | 7 1/2" |  |

*Product has open cavity.



Parts may be required to ship LTL (less than truckload) based on size and overall dimensions.













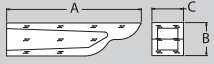

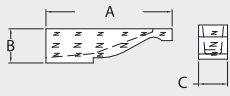

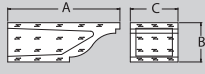

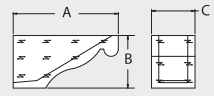

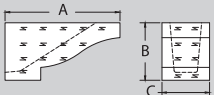
Corbels - Scroll

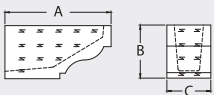
(items are approximate scale only)

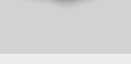
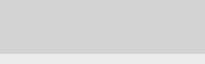
Corbels - Scroll

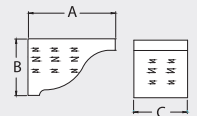
Standard Woodgrain

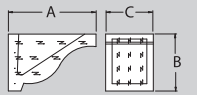
| | Part Number | Projection (A) | Height (B) | Overall Width (C) | |
|--|--------------|----------------|------------|-------------------|---|
|  | COROG24X6S* | 24" | 5 7/8" | 5 5/8" |  |
|  <small>NON-STOCK SPECIAL ORDER ITEM</small> | COR24X6X5S* | 24" | 6 1/2" | 5 1/2" |  |
|  | COROG20X7S* | 20" | 7" | 8 1/2" |  |
|  <small>NON-STOCK SPECIAL ORDER ITEM</small> | COROG15X7S* | 14 1/2" | 7 1/4" | 6" |  |
|  <small>NON-STOCK SPECIAL ORDER ITEM</small> | COROGA15X7S* | 14 1/2" | 7 1/4" | 6" |  |
|  <small>NON-STOCK SPECIAL ORDER ITEM</small> | COROGD15X7S* | 14 1/2" | 7 1/4" | 6" |  |
|  | COROG29X8S* | 28 3/8" | 7 3/8" | 7 3/8" |  |
|  <small>NON-STOCK SPECIAL ORDER ITEM</small> | COROG48X8S* | 48" | 7 3/8" | 7 3/8" |  |
|  <small>NON-STOCK SPECIAL ORDER ITEM</small> | COR7X11S | 11 3/8" | 7 3/8" | 7" |  |
|  | COROG8X12S* | 11 3/8" | 7 3/8" | 7 3/8" |  |

*Product has open cavity.



(items are approximate scale only)

Corbels - Scroll



Corbels - Scroll

Standard Woodgrain
Continued

NON-STOCK
SPECIAL ORDER ITEM

| Part Number | Projection (A) | Height (B) | Overall Width (C) |
|---|----------------|------------|-------------------|
|  COR39X10X5.5S* | 39 1/4" | 9 1/8" | 5 1/2" |
|  COR16X10X8S* | 16" | 10 1/2" | 8" |
|  COR12X12X4-7S* | 12" | 12" | 4" |
|  COR14X12X6S* | 14" | 12" | 6" |
|  COR11X13X6S* | 11" | 13" | 6" |

*Product has open cavity.











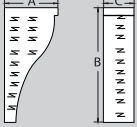

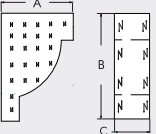
Corbels - Assorted

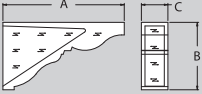
(items are approximate scale only)

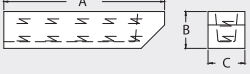
Corbels - Assorted

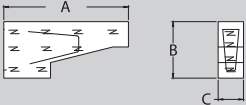
Standard Woodgrain

| Part Number | Projection (A) | Height (B) | Overall Width (C) | |
|--|----------------|------------|-------------------|---|
|  <p>COR7X15X4S NON-STOCK SPECIAL ORDER ITEM</p> | 7" | 15" | 4" |  |
|  <p>COR12X18X6S NON-STOCK SPECIAL ORDER ITEM</p> | 12" | 18" | 6" |  |
|  <p>COROG34X19S*</p> | 33 3/4" | 18 3/4" | 7 3/8" |  |
|  <p>COR24X5X5S* NON-STOCK SPECIAL ORDER ITEM</p> | 24" | 5 1/2" | 5 1/2" |  |
|  <p>COR16X7X3S* NON-STOCK SPECIAL ORDER ITEM</p> | 16" | 7 1/4" | 3 1/4" |  |
|  <p>COR16X7X5S* NON-STOCK SPECIAL ORDER ITEM</p> | 16" | 7 1/4" | 5 1/2" | |

*Product has open cavity.



(items are approximate scale only)







Corbels - Assorted

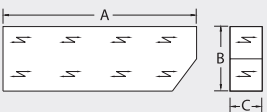

Corbels - Assorted

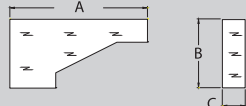
Standard Woodgrain
Continued

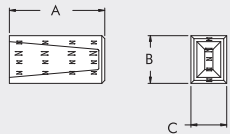
NON-STOCK
SPECIAL ORDER ITEM

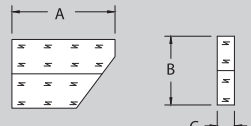
| Part Number | Projection (A) | Height (B) | Overall Width (C) | |
|---|----------------|------------|-------------------|---|
|  COR24X8X4S | 24" | 8" | 4" |  |
|  COR18X9X3S | 18" | 9" | 3" |  |
|  COR16X8S* | 16" | 8" | 6" |  |
|  COR24X16X4S | 24" | 16" | 4" |  |

*Product has open cavity.







Rafter Tails

(items are approximate scale only)

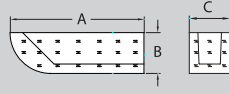
Rafter Tails

Standard Woodgrain

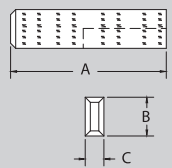
| | Part Number | Length | Height | Overall Width | |
|--|----------------|--------|--------|---------------|--|
|  | BMRTS4X4X24S* | 24" | 3 1/4" | 3 1/4" |  |
| | BMRTS6X4X24S* | 24" | 5 1/4" | 3 1/4" | |
| | BMRTS6X6X24S* | 24" | 5 1/4" | 5 1/4" | |
| | BMRTS8X4X24S* | 24" | 7 1/4" | 3 1/4" | |
| | BMRTS8X6X24S* | 24" | 7 1/4" | 5 1/4" | |
|  | BMRTBN8X4X30S* | 30" | 7 3/4" | 4" |  |
| NON-STOCK SPECIAL ORDER ITEM | | | | | |
|  | BMCRT25X12X6S* | 25" | 12" | 6" |  |
| NON-STOCK SPECIAL ORDER ITEM | | | | | |

*Product has open cavity.



(items are approximate scale only)

Rafter Tails



Rafter Tails

Standard Woodgrain
Double-Ended

NON-STOCK
SPECIAL ORDER ITEM

| | Part Number | Length | Height | Overall Width | |
|---|----------------|--------|--------|---------------|---|
|  | BMRTDE6X4X36S* | 36" | 6" | 4" |  |

*Product has open cavity.



Window & Door Trim

WINDOW & DOOR TRIM



(items are approximate scale only)

Crossheads - Classic

5.5" Crossheads - Classic

Smooth Cedar

NON-STOCK
SPECIAL ORDER ITEM

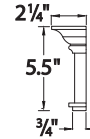
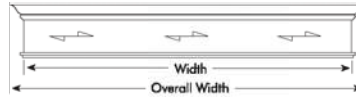

| Part Number | Width | Overall Width |
|-------------|-------|---------------|
| CHAC33X5.5S | 33" | 36" |
| CHAC39X5.5S | 39" | 42" |
| CHAC72X5.5S | 72" | 75" |

7.5" Crossheads - Classic

Smooth Cedar

NON-STOCK
SPECIAL ORDER ITEM

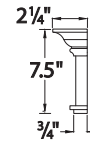
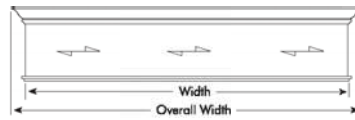

| Part Number | Width | Overall Width |
|-------------|-------|---------------|
| CHAC33X7.5S | 33" | 36" |
| CHAC39X7.5S | 39" | 42" |
| CHAC72X7.5S | 72" | 75" |

9.5" Crossheads - Classic

Smooth Cedar

NON-STOCK
SPECIAL ORDER ITEM

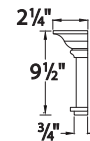
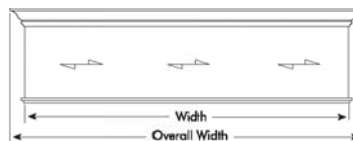



| Part Number | Width | Overall Width |
|-------------|-------|---------------|
| CHAC33X9.5S | 33" | 36" |
| CHAC39X9.5S | 39" | 42" |
| CHAC72X9.5S | 72" | 75" |

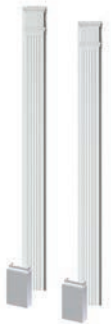

Parts may be required to ship LTL (less than truckload) based on size and overall dimensions.

Polyurethane Pilasters / Corbels / Louvers

(items are approximate scale only)

| Pilasters | Part Number | Width | Height | Plinth Height |
|---|--|--------|--------|---------------|
|  | PIL6X108 2-Piece Adjustable Fluted Pilaster w/Plinth <i>(sold in sets only)</i> | 6-1/4" | 108" | 13-1/4" |
| | PIL8108 2-Piece Adjustable Fluted Pilaster w/Plinth <i>(sold in sets only)</i> | 8" | 108" | 13" |

| Corbel | Part Number | Width | Height | Projection |
|---|--|-------|--------|------------|
|  | COR5X10 Recessed Decorative Corbel | 4" | 10" | 5-1/4" |

| Functional Louvers | Part Number | Width | Height | Outside Diameter | Trim Width | Trim Thickness | Vent Area |
|---|---|-------|--------|------------------|------------|----------------|------------|
|  | FLV16X24 Functional Vertical Smooth Louver | 16" | 24" | | | | 21 sq. in. |
|  | FRLV16 Functional Round Smooth Louver | | | 16" | | | |
| | FRLV18 Functional Round Smooth Louver | | | 18" | | | |
| | FRLV22 Functional Round Smooth Louver | | | 22" | | | |
| | FRLV24 Functional Round Smooth Louver | | | 24" | | | |
|  | FRLV24TK Round Smooth Louver with Flat Trim and Keystones | 24" | 24" | 22-7/8" | 3-1/2" | 1" | 10 sq. in. |

| Decorative Louvers | Part Number | Width | Height | Outside Diameter | Trim Width | Trim Thickness | Vent Area |
|---|--|-------|--------|------------------|------------|----------------|-----------|
|  | RLV18 Decorative Round Smooth Louver | | | 18" | | | |

(items are approximate scale only)

Polyurethane Crown

| Crown | Part Number | Projection | Height | Length | Bottom Thickness | Tooth | Pattern Repeats |
|---|---|------------|---------|--------|------------------|--------|-----------------|
|  | MLD405-12 Florentine Dentil Crown | 3-5/8" | 5-3/4" | 12'-6" | 5/8" | 5/8" | 12-1/2" |
|  | MLD410-12 Roman Dentil Crown | 3-1/4" | 6-7/8" | 12' | 1/2" | 1-1/2" | 3" |
|  | MLD425-12 Tuscan Dentil Crown w/Swag | 4-1/8" | 9-1/2" | 11'5" | 3/4" | 5/8" | 13-1/2" |
|  | MLD432-12 Classic Dentil Crown | 4" | 4-1/2" | 12'-3" | 1/4" | 1/2" | 1" |
|  | MLD460-12 Classic Crown | 4-3/8" | 5-1/8" | 12' | 3/4" | | |
|  | MLD490-12 Florentine Crown | 6" | 5-1/2" | 11'-5" | 1/4" | | 13" |
|  | MLD493-12 Greek Acanthus Leaf Crown | 5-1/2" | 6-5/8" | 12' | 3/8" | | 4" |
|  | MLD495-16 Leaf Crown | 5-3/8" | 10-1/8" | 16' | 5/8" | | 7-3/4" |
|  | MLD560-8 Egg & Dart Crown | 5-3/4" | 9-1/8" | 8' | 1-3/8" | | 5-1/4" |
|  | MLD564-16 Egg & Dart Crown | 2-5/8" | 5-7/8" | 16' | 1/4" | | 2-3/4" |
|  | MLD732-12 Classic Egg & Dart w/Acanthus Leaf Crown | 4-3/4" | 7-1/4" | 12' | 5/8" | | 5-3/8" |

Polyurethane Ceiling Medallions

(items are approximate scale only)

| Ceiling Medallions | Part Number | Width | Height | Outside Diameter | Inside Diameter | Projection |
|---|---|---------|---------|------------------|-----------------|------------|
|  | CM36NI Nicolas Ceiling Medallion with 2" Hole | | | 35-3/4" | 2" | 2" |
|  | CM38SY Symmetria Ceiling Medallion with 1" Hole | 38-1/8" | 28-5/8" | | 1" | 1-3/4" |
|  | CM67WT Whitney Ceiling Medallion with 4-3/8" Hole | 67-1/2" | 43-1/2" | | 4-3/8" | 1" |
|  | CM74SF Suffolk Ceiling Medallion | | | 74-1/4" | | 2" |
|  | CM15BM Beaumont Ceiling Medallion with 1" Hole | | | 14-3/8" | 1" | 2-1/4" |
|  | CM16FL Florentine Ceiling Medallion with 4-1/8" Hole | | | 16" | 4-1/8" | 1-1/8" |

(items are approximate scale only)

Polyurethane Ceiling Medallions

| Ceiling Medallions | Part Number | Width | Height | Outside Diameter | Inside Diameter | Projection |
|---|--|-------|--------|------------------|-----------------|------------|
|  | CM16FL2 Split Florentine Ceiling Medallion with 5-5/8" Hole | | | 15-3/4" | 5-5/8" | 1-5/8" |
|  | CM16JE2 Split Jefferson Ceiling Medallion with 5-3/4" Hole | | | 15-1/2" | 5-3/4" | 3/4" |
|  | CM24RN Randolph Ceiling Medallion with 1" Hole | | | 24-3/8" | 1" | 1-1/2" |
|  | CM30AL Acanthus Leaf Ceiling Medallion with 1" Hole | | | 30-1/4" | 1" | 2-1/2" |
|  | CM32R02 Split Rochelle Ceiling Medallion with 5-3/4" Hole | | | 31-7/8" | 5-3/4" | 2-1/4" |
|  | CM32SG St. George Ceiling Medallion with 1" Hole | | | 32-1/2" | 1" | 2-1/2" |

Big Ideas

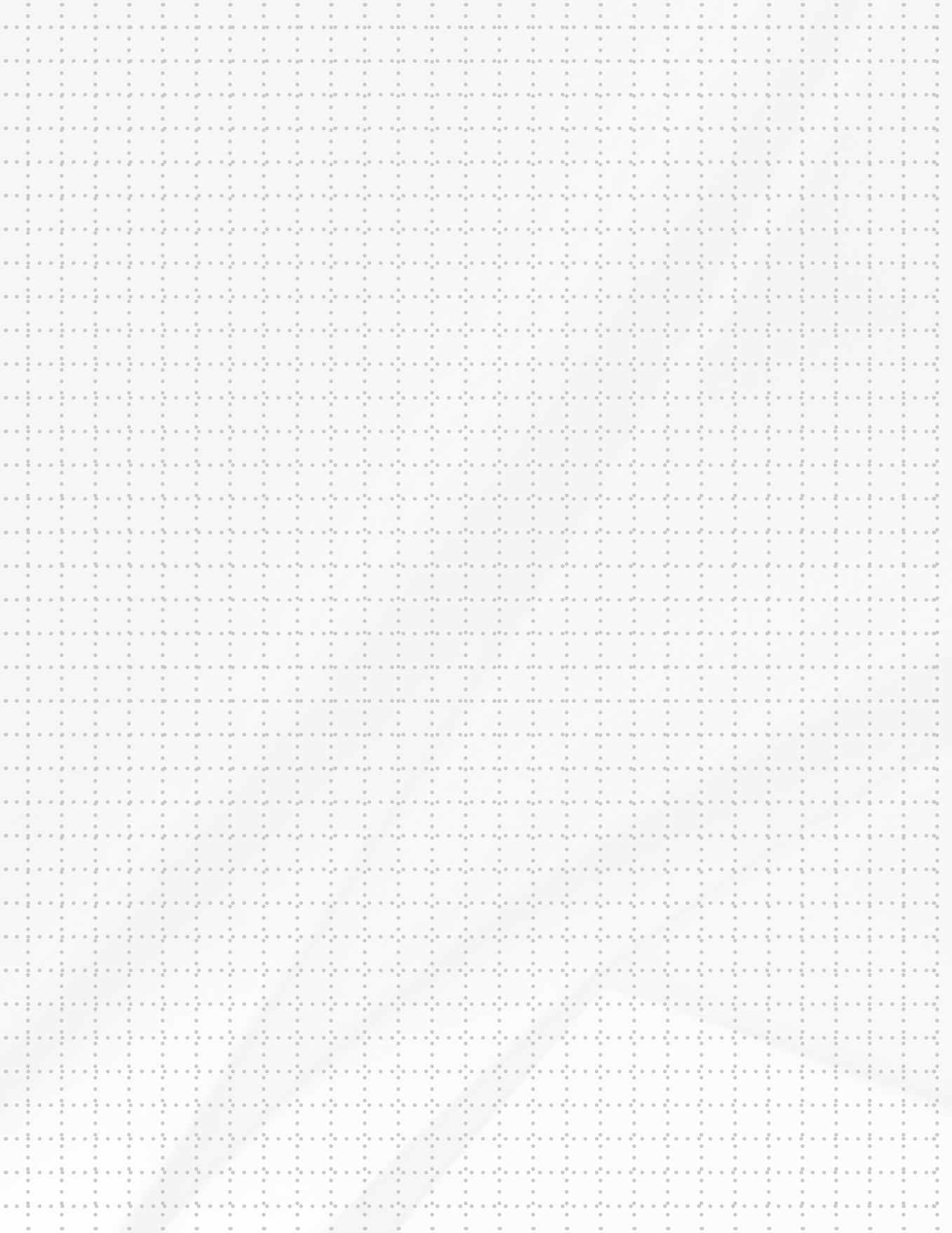

Protected Exterior Bodyguard® Sidings, S1S2E Trimboards & Exterior Mouldings



ECOLOGICAL AND DURABLE STRUCTURAL PROTECTION



CALIFORNIA FIRE APPROVAL

Bodyguard® has had profiles successfully tested by Western Fire Center Inc., to California State Fire Marshall Regulations.

SIDINGS

Tested in accordance with California State Fire Marshall Regulation 12.7A-1. This approval is for horizontal applications only and requires installation over OSB with a minimum thickness of 7/16".

UNDER EAVES

Tested in accordance with California State Fire Marshall 12.7A-3. This approval is for beaded T&G product (#801BG & #802BG) and must be mounted over a minimum of 1/2" exterior grade gypsum board.

Until now, it's been hard for contractors and homeowners to find genuine wood building solutions they can trust to last, and that look great. Bodyguard® is the original producer of treated FJ Pine products from New Zealand. Protected by an environmentally friendly preservative, Bodyguard® products provide long-lasting life and protection against decay, corrosion and insects. Sourced from the clean, green sustainable pine forests of New Zealand, these products are environmentally safe, easy to use and come with a 30-year warranty.

Sold exclusively through EL & EL Wood Products.

section contents

| | |
|---|-----|
| Bodyguard® Exterior Primed Millwork..... | 97 |
| Bodyguard® Interior / Exterior T&G..... | 96 |
| Bodyguard® Fire Rated Primed FJ Siding... | 94 |
| Bodyguard® Protected Siding | 93 |
| Bodyguard® Protected Trimboards | 93 |
| Pakari Trimboards..... | 100 |



Bodyguard® Primed FJ Pine

I/E

DESIGN STYLES

TRADITIONAL | CONTEMPORARY | COASTAL

**JANKA
HARDNESS**
(POUNDS-FORCE)

N/A



Natural Wood Solutions For Today's Building Challenges!



SUSTAINABLE - Bodyguard® wood products come from the well-managed pine plantation forests in clean, green New Zealand.



PROTECTED - The unique pressure treatment achieves total "active penetration" protection of the wood. The addition of waxes and resins boosts its water protection properties. The active ingredients used in this treatment process (known as Light Organic Solvent-borne Preservatives (LOSP's) do not dissolve in water and will not be removed through leaching.



ENVIRONMENTALLY FRIENDLY AND SAFE - The Bodyguard® preservative system is based on carbon based biocides and is registered in the United States of America by the EPA. As Bodyguard® is real wood and contains no hazardous additives it is safe to work with, just follow normal workplace safety practices for handling wood products.



DEFECT FREE - Bodyguard® is a natural wood product manufactured from kiln-dried timber. All defects, such as knots and resin pockets, are removed prior to fingerjointing.



TERMITE RESISTANT - One of the active protective ingredients in Bodyguard® is Permethrin, a food-crop protection product effective against all known species of termite.



FSC CERTIFIED - By buying products with an FSC label you are helping to promote responsible forest management worldwide. Ask for our supply availability of FSC certified products. (SCS-COC-00538 / SCS-COC-004440 / SGS-COC-003178 / RA-COC-005483).



GREEN BUILDING CREDITS - Bodyguard® qualifies for credit points under the following schemes:

- LEED for Homes
- NAHB Model Green Home Building Guidelines
- GreenPoint Rated (California only)



PAINT-READY FINISH - The machined finish of Bodyguard® is enhanced by a two-coat alkyd primer system and comes with a performance warranty. A good-quality acrylic paint system to the manufacturer's specifications will finish the appearance and protection of Bodyguard® perfectly.



SUITABLE FOR USE INSIDE AND OUTSIDE - Bodyguard® is safe for interior and exterior above ground use. We recommend application of finishing coats as soon as practicable after installation. Make sure your Bodyguard® product is dry before painting.



NON-CORROSIVE - The protection system's (LOSP's) do not contain any corrosive heavy metals and will not cause corrosion to nails and other fastening systems. Durable fasteners are recommended as good building practice for exterior applications.



EASE OF USE - No special tools, cutting equipment or fixing methods are required with Bodyguard®.



30 YEAR WARRANTY - A 30-year limited warranty is provided on all Bodyguard® products against termite attack, rot or fungal decay.

PAINTING & INSTALLATION

BODYGUARD® IS PRE-PRIMED (DOUBLE COATED) AND THE FOLLOWING IS RECOMMENDED:

- ❖ Bodyguard products must be painted as soon as practicable after installation.
- ❖ Bodyguard products must be dry before commencing painting (a moisture content of 14% or less).
- ❖ Apply top coat in warm, dry weather not below 50° F.
- ❖ Painting with solid acrylic stains is not recommended as UV light will penetrate the transparent stain and damage the primer paint.
- ❖ We recommend application of the first top coat prior to installation.

1. Nail holes: if nails are countersunk, seal exposed wood with Bodyguard End Seal then fill nail holes with an exterior grade wood filler, then spot prime. In temperatures less than 40°F use cold weather caulking sealants.
2. Remove all soft and chalky paint, dirt, and sand etc. to a smooth even finish.
3. Apply two full coats of premium quality exterior acrylic house paint as per manufacturer's instructions. For best results allow 24hrs between coats.
4. The use of colors with a Light Reflectance Value (LRV) of 45 or more is recommended, as these lighter colors reflect significantly more heat.
5. When cutting or re-machining; brush or spray-on a preservative containing zinc naphthen, Bodyguard End Seal is recommended.
6. **Corrosion resistant fasteners such as hot dipped galvanized nails or stainless steel nails must be used when installing.**
7. All nails should be countersunk and puttied prior to paint.

NOTE: ALL WOOD EXPANDS AND CONTRACTS. It is important to leave 1/8" gap between each piece of siding to allow for expansion. Failure to do so will void warranty and may cause serious issues.



(items are approximate scale only)

Bodyguard® FJ Pine Treated & Protected Siding/ S1S2E Trimboards & Exterior Mouldings



S1S2E TRIMBOARDS

For interior and exterior use. Reversible; rough-sawn on one side, smooth on the other with eased edges. Bodyguard® is manufactured with superior quality and performance in mind.

The result is a product that maintains its appearance and integrity as a uniform and quality building solution. The Bodyguard® product range consists of trimboards, sidings and exterior mouldings in a wide range of profiles and choices.

For homeowners and contractors who prefer the naturalness of wood; who value a durable solution; and who appreciate the confidence shown through a warranty and position. Bodyguard® provides a real wood solution for today's building challenges.



PLEASE REFER TO INSTALLATION AND PAINTING GUIDELINES.

PROTECTED TRIMBOARDS: S1S

| Protected S1S2E Trimboards Interior/Exterior Primed FJ Pine | | | |
|--|------------------|-----------------|-----------|
| ITEM | BODYGUARD PART # | SIZE | LENGTHS |
| 1X2S1S | 710 | 3/4 x 1-1/2" | 16' |
| 1X3S1S | 711 | 3/4 x 2-1/2" | 16' & 20' |
| 1X4S1S | 712 | 3/4 x 3-1/2" | 16' & 20' |
| 1X6S1S | 714 | 3/4 x 5-1/2" | 16' & 20' |
| 1X8S1S | 716 | 3/4 x 7-1/4" | 16' & 20' |
| 1X10S1S | 718 | 3/4 x 9-1/4" | 16' & 20' |
| 1X12S1S | 720 | 3/4 x 11-1/4" | 16' & 20' |
| 5/4X4S1S | 723 | 1" x 3-1/2" | 16' & 20' |
| 5/4X6S1S | 724 | 1" x 5-1/2" | 16' & 20' |
| 5/4X8S1S | 725 | 1" x 7-1/4" | 16' & 20' |
| 2X2S1S | 722 | 1-1/2 x 1-1/2" | 16' & 20' |
| 2X4S1S | 713 | 1-1/2 x 3-1/2" | 16' & 20' |
| 2X6S1S | 715 | 1-1/2 x 5-1/2" | 16' & 20' |
| 2X8S1S | 717 | 1-1/2 x 7-1/4" | 16' & 20' |
| 2X10S1S | 719 | 1-1/2 x 9-1/4" | 16' & 20' |
| 2X12S1S | 721 | 1-1/2 x 11-1/4" | 16' & 20' |

- ✓ Reversible S1S
- ✓ 1side Rough Sewn
- ✓ 1side Smooth
- ✓ 30 Year Limited Warranty

Bodyguard® Fire Rated Primed FJ Siding

✦ lengths available: all 16' & 20' only with 1/2" overlap

(items are approximate scale only)
CALIFORNIA FIRE APPROVAL

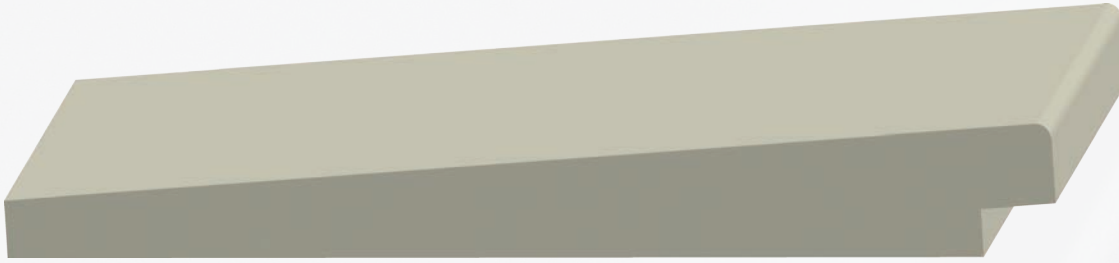

371 1 1/16 x 5-1/2 **Rab't Smooth Face Siding** N/S | **372** 1 1/16 x 7-1/2 **Rab't Smooth Face Siding** N/S

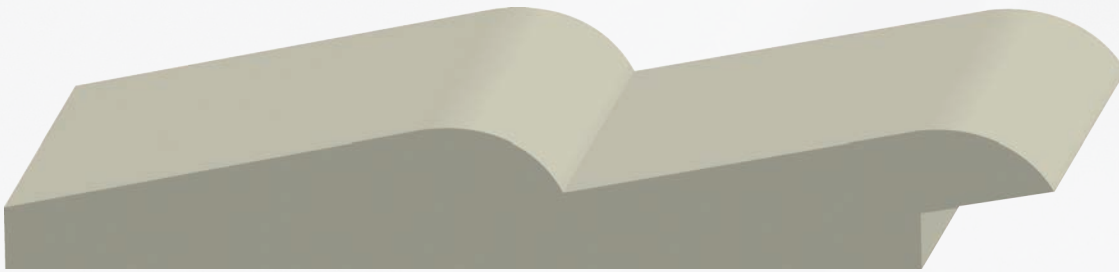

430 3/4 x 5-1/2 **2 Lap Siding** N/S



774 3/4 x 7-1/2 **Bevel Channel Siding** N/S | **773** 3/4 x 9-1/2 **Bevel Channel Siding** N/S



432 3/4 x 7-1/2 **3 Lap Siding** N/S | **433** 3/4 x 9-1/2 **3 Lap Siding** N/S

(items are approximate scale only)
CALIFORNIA FIRE APPROVAL

Bodyguard® Fire Rated Primed FJ Siding

lengths available: all 16' & 20' only with 1/2" overlap



793 3/4 x 5-1/2 **V-Rustic Siding** N/S
794 3/4 x 7-1/2 **V-Rustic Siding** N/S

795 3/4 x 9-1/2 **V-Rustic Siding** N/S



771 3/4 x 7-1/2 **Cove Siding** N/S

772 3/4 x 9-1/2 **Cove Siding** N/S

COMING SOON
in early 2018!

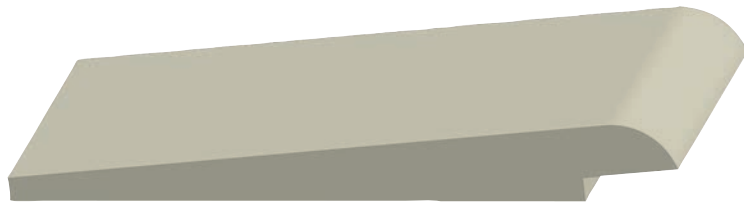

1x4BS 1/2 x 4 **#400 Bevel Siding** N/S



1x6NGS 1x6 **Nickel Gap Siding** N/S



Bodyguard® Interior / Exterior T&G

(items are approximate scale only)

✦ lengths available: all 16'

Protected T&G Bead Boards For Interior and Exterior Use

Smooth Surface, Four Sides. Available in 16' lengths. Reversible: Flat or Beaded

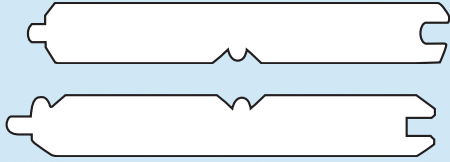

801BG 5/8 x 4 T&G Beaded Wainscot *N/S*
(Exposed face is 3-1/8) *[reversible]*



802BG 1 x 6 T&G Beaded Wainscot *N/S*
(Exposed face is 5-1/8) *[reversible]*

Bodyguard® Exterior Primed & Protected Millwork

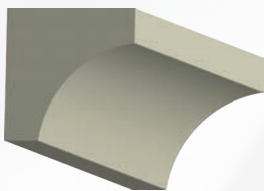

606 11/16 x 11/16 x 16'
Cove *N/S*



614 11/16 x 11/16 x 16'
Quarter Round *N/S*

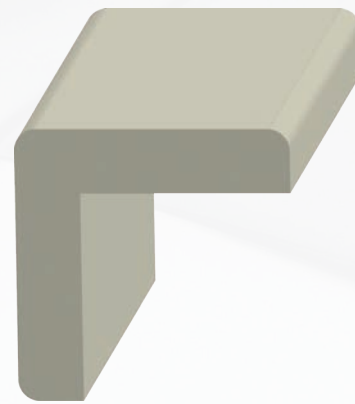

604 1-7/16 x 1-7/16 x 16'
Outside Corner Guard *N/S*

Bodyguard® Testing & Approvals

CALIFORNIA FIRE APPROVAL

Bodyguard has had profiles successfully tested by Western Fire Center Inc., to California State Fire Marshall Regulations.

Sidings: Tested in accordance with California State Fire Marshall Regulation 12.7A-1. This approval is for horizontal applications only and requires installation over OSB with a minimum thickness of 7/16".

Under Eaves: Tested in accordance with California State Fire Marshall Regulation 12.7A-3. This approval is for beaded T&G product (#801BG & #802BG) and must be mounted over a minimum of 1/2" exterior grade gypsum board.

Bodyguard® FJ Pine Exterior Primed & Protected Millwork

(items are approximate scale only)



224 9/16 x 3/4 x 16' **Base Cap** N/S

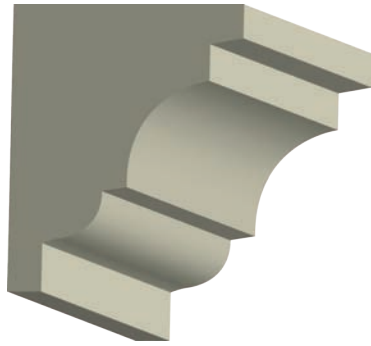

607 1-1/4 x 1-1/2 x 16' **Pediment Crown** N/S

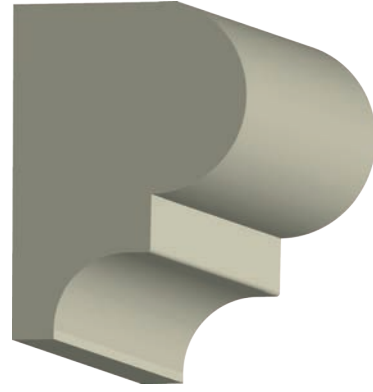

024 1-1/4 x 1-3/4 x 17' **Bead & Nose Coving** N/S



387 1-1/16 x 3-1/4 x 17' **Howe Casing** N/S



388 11/16 x 3-1/4 x 17' **Carolina Casing** N/S



1400 1-3/16 x 4-1/4 x 17' **Architrave** N/S



616 11/16 x 1-5/8 **Shingle Mold** N/S

✦ lengths available: 16'



629 1 x 2-5/8 **Stucco Mold** N/S

✦ lengths available: 17'



Bodyguard® Exterior Primed & Protected Millwork

(items are approximate scale only)

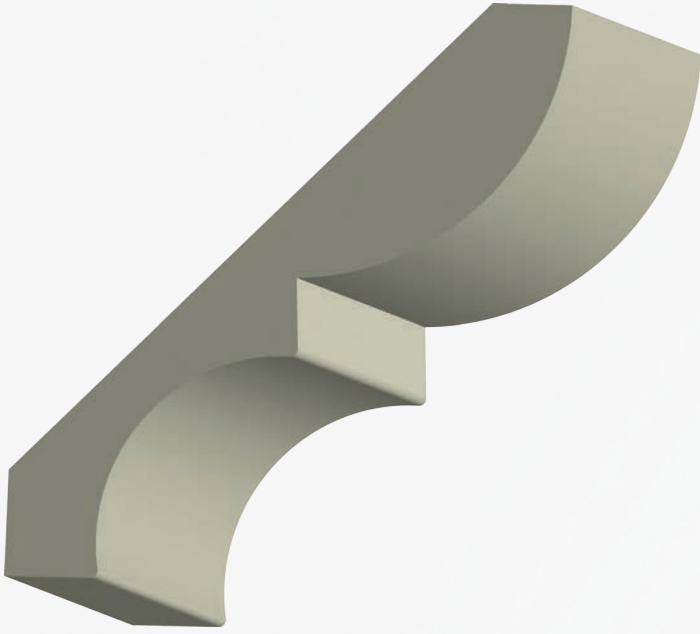

639 3/4 x 4-5/16 x 16' **Bed & Cove** N/S

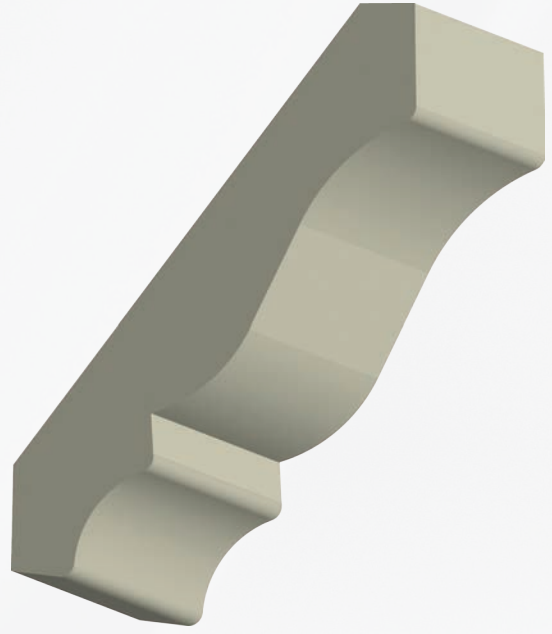

286 5/8 x 3-5/8 x 16' **Colonial Crown** N/S

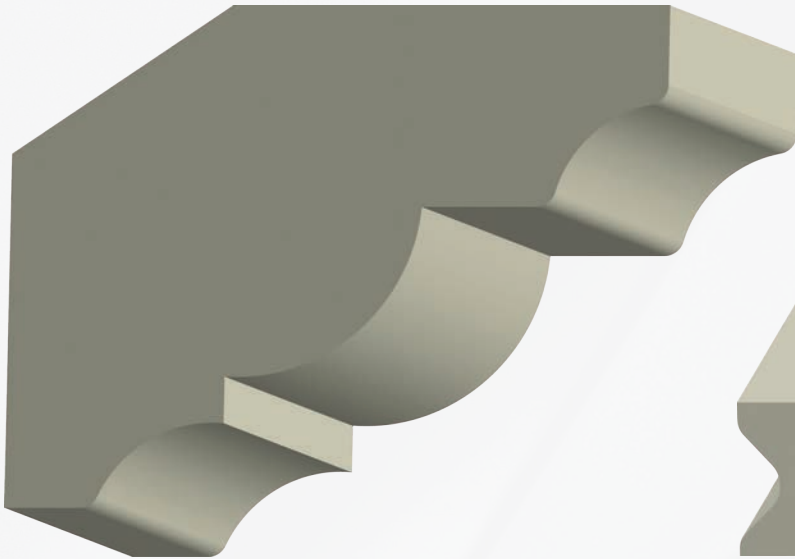

638 1-3/8 x 3-5/16 x 16' **Gutter Mould** N/S

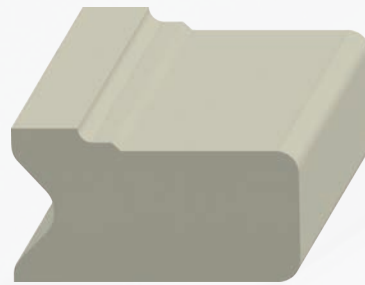

618 13/16 x 1-1/2' **Stucco Mold** N/S
lengths available: 17'

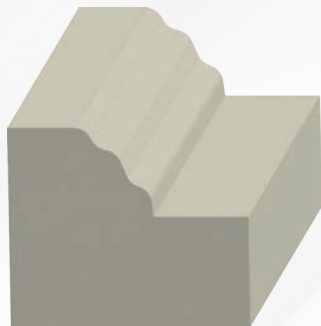

619 1-1/4 x 1-1/2 x 16' **Brick Mold** N/S
lengths available: 16'



627 15/16 x 1-15/16' **Step Stucco Mold** N/S
lengths available: 17'



Bodyguard® Exterior Primed & Protected Millwork

(items are approximate scale only)

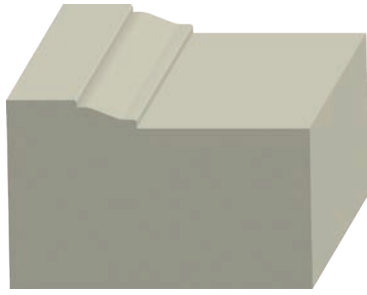

381 1-1/4 x 2 #180 Eastern Brick Mold without Stucco Key *N/S*
 lengths available: 17'

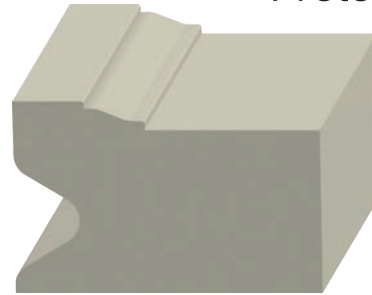

381K 1-1/4 x 2 #180 Eastern Brick Mold w/Stucco Key *N/S*
 lengths available: 17'

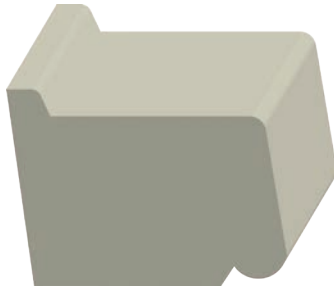

630 1-7/16 x 2-1/16 **Watertable** *N/S*
 lengths available: 16' only



634 1-7/16 x 3-1/4 **Watertable** *N/S*
 lengths available: 16' only



642 1-3/8 x 7 **Detailed Sill** *N/S*
 lengths available: 16'

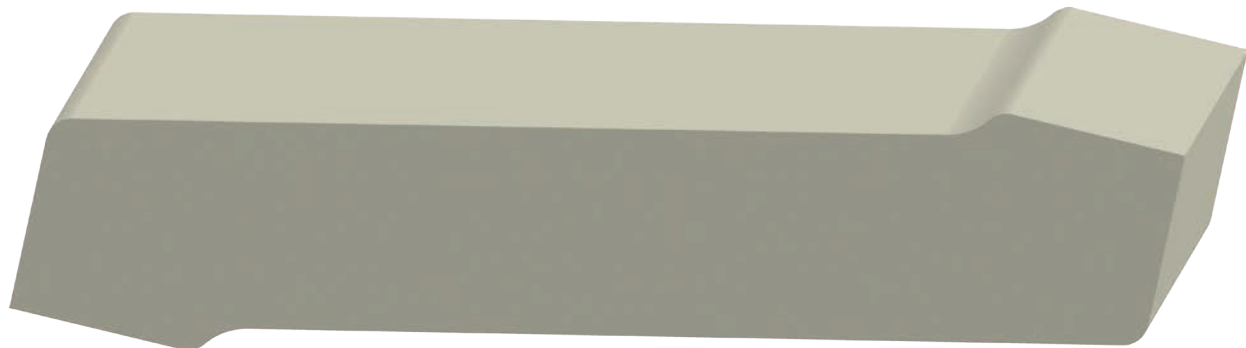

640 1-3/8 x 7 **Protected Reversible Sill** *N/S*
 lengths available: 16'

Pakari Interior/Exterior Trimboards



(items are approximate scale only)

✦ lengths available: 8' thru 16'

Introducing...Pakari,
a thermally modified Pine
wood that is chemical
free using a simple heat
treatment of steam and
high temperatures.



- ✓ FSC Certified
- ✓ Chemical Free Modification
- ✓ Insect & Rot Resistant
- ✓ Natural Rustic Appearance
- ✓ Lightweight
- ✓ Long Lengths
- ✓ Renewable Resource

Once the pine wood has been put through the unique process of Thermal Modification it is improved at the molecular level, taking on an abundance of new benefits; increased durability, stability, and even a reduction in the weight of the wood. The Pine wood turns into a rich chocolate brown color that is normally only seen in exotic hardwoods. If left untreated under direct sunlight, Pakari will eventually weather to a natural silver patina. To keep Pakari at its original chocolate brown color, it is recommended to use a UV protective coating.

Pakari's long length structure and lighter weight add up to a lower installation cost while providing an exotic look with a variety of design options.

Pakari is versatile enough to use indoor or outdoor. If used for an outdoor application, we recommend all Thermally Modified products be installed at least 12" above the ground and for siding application, using proper gap and nailing procedures to allow for normal wood expansion.



PAK1x4BW 11/16 x 3-5/8 **Pakari Rustic Barnwood Lumber** N/S



PAK1x6BW 11/16 x 5-3/4 **Pakari Rustic Barnwood Lumber** N/S



PAK1x6LAP 11/16 x 5-7/16 **Pakari Lap-Joint Paneling** N/S



DECKING SIDING TRIM INTERIOR DESIGN & DECOR



Solid Pine



BEAUTIFULLY GRAINED AND EASY TO WORK WITH



Solid Pine is beautifully grained, easy to work with and offers many choices for finishing. Pine can simply be clear coated to show its natural warmth, or it can be stained in a variety of colors, antiqued, or painted. Solid Pine often has a special place in the hearts of those who love wood.

When staining pine it is recommended to use a highly trained professional, as pine is a softwood that can absorb stain differently across the wood creating a blotchy look.



section contents

| | |
|---|-----|
| Astragal..... | 118 |
| Base | 107 |
| Base Shoe & Cap | 107 |
| Casing..... | 101 |
| Chair Rail..... | 117 |
| Cove | 116 |
| Crown..... | 112 |
| Exterior Molds | 121 |
| Full Round | 121 |
| Half Round | 116 |
| Interior Door Jambs | 124 |
| Lattice | 121 |
| Outside Corner Guard..... | 120 |
| Panel Cap..... | 118 |
| Panel & Decorative Mold..... | 119 |
| Quarter Round | 116 |
| S4S..... | 121 |
| Standard Door Frame | 124 |
| T&G Wainscot..... | 122 |
| Weatherstrip Kerfed Eext. Door Frames | 124 |
| Window & Door Stop..... | 106 |
| Window Stool..... | 122 |

guide

SPECIES

Solid Pine

DESIGN STYLES

TRADITIONAL | RUSTIC

INTERIOR/EXTERIOR

I/*E

JANKA
HARDNESS
(POUNDS-FORCE)

380

CUT LIST

Determining How Much You Need

- 1 Measure the room at the height or length where each moulding goes to determine the number and the length of the pieces you'll need.
- 2 Solid pine moulding is available in 8-16 ft. lengths. Add your footage and multiply that number by 1.1. The result is the total footage needed plus ten percent for waste. Perform this step for each type of moulding, base, chair rail and crown, separately.
- 3 When ordering casing for 6/8 doors, order 7' or 8' lengths and for 8/0 doors use 9' or 10' lengths.
- 4 Most door heads are cut from lineal random lengths. Always cut the longest pieces first.
- 5 The most important tool when working with moulding is **patience**. Remember the old adage, measure twice and cut once. Never try to rush trim work.
- 6 Lengths ordered may not always be available. Always verify availability when ordering.

ALWAYS TEST TO MAKE SURE YOUR MEASURING TOOLS ARE ACCURATE. IF YOU ARE WORKING WITH A HELPER, TAKE A MEASUREMENT WITH ONE TOOL WHILE YOUR HELPER MEASURES WITH ANOTHER AND COMPARE YOUR RESULTS.

HELPFUL HINTS

- * **Chair rails** can be installed 32" to 36" from the floor.
- * Base, shoe and quarter rounds should be the **last mouldings to be installed**.
- * Use Rosettes and Plinth blocks at the corners of windows and doors to **eliminate the mitering process**.
- * Use any brand of spray furniture polish on saw blade as a **lubricant for easier cutting**.
- * **After installation is complete:** caulk and/or putty all gaps and nail holes with wood putty.
- * **CHECK the moisture content of all wood moulding:** for interior trim, the MC should be 8-10%; for exterior trim the MC should be 12-14%. For every 4% change in MC, wood moves 1%.

FINISHING

1 Sand the surface of the pine moulding until it is smooth. Finish it with at least a 220 grit sandpaper for best results. Remove dust with a tack rag or by blowing the moulding clean with compressed air.

2 Apply a thin coat of the prepared shellac to the moulding using a clean cloth. Allow the shellac to dry. Sand lightly with 320 grit sandpaper to smooth the surface; don't remove the shellac layer. Remove dust from the surface before applying stain or another coat. Each coat of shellac will decrease the amount of stain that can penetrate the wood.

3 Pour 1 cup of shellac into a quart container. Add three cups of denatured alcohol. Stir well. Place a lid on the container until you are ready to use the thinned shellac.

4 Apply stain with a clean cloth. Stir the container of stain frequently as you work to maintain consistent color. Leave the stain on for the desired amount of time, then wipe thoroughly with a clean cloth. Sand lightly between coats of stain and before applying a protective clear coat.



SOLID PINE CAN ABSORB STAIN UNEVENLY. ALWAYS APPLY A LIBERAL COAT OF A PRE-STAIN WOOD CONDITIONER PRIOR TO STAINING AND, EVEN THEN, SELECT LIGHT TO MEDIUM COLORS FOR STAINING.

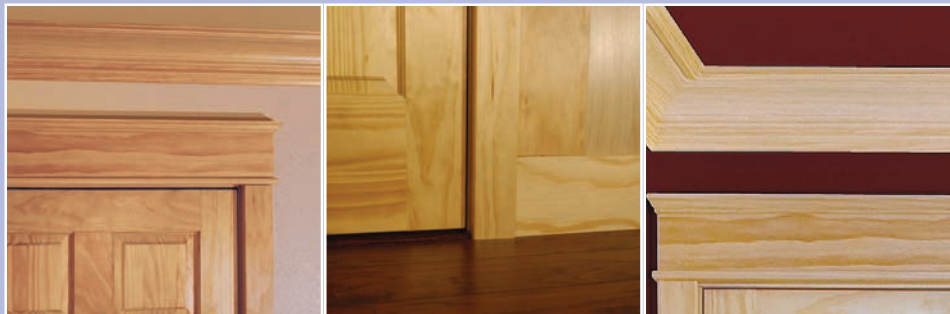

*EXTERIOR ITEMS CAN BE FOUND ON P.121 and 124



1-1/8" to 1-5/8" Casing

lengths available: 7' thru 16'

(arranged in order of width; items are approximate scale only)

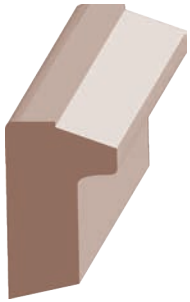

190SP 11/16 x 1-1/8
Solid Pine Back Band S
 (lips 9/16")

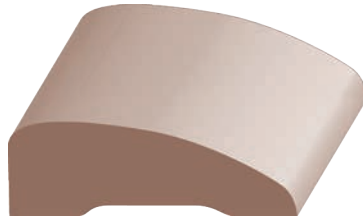

104SP 1/2 x 1-1/2
Solid Pine Streamline Casing S



100SP 9/16 x 1-5/8
Solid Pine 2 Round Edge Casing N



101SP 1/2 x 1-5/8
Solid Pine Streamline Casing S

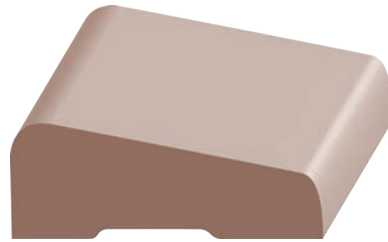

102SP 5/8 x 1-5/8
**Solid Pine Flat Beveled/
 Streamline Casing** N/S

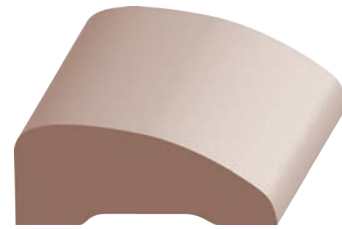

105SP 5/8 x 1-5/8
Solid Pine Oval/Streamline Casing N/S

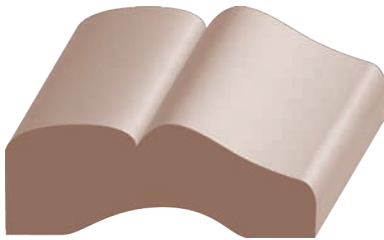

107SP 5/8 x 1-5/8
Solid Pine #711 Casing S

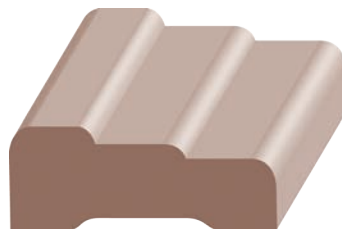

109SP 5/8 x 1-5/8
Solid Pine 3-Step Casing N/S

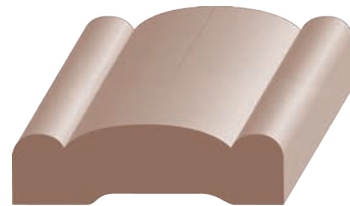

111SP 1/2 x 1-5/8
Solid Pine Bead & Barrel Casing S

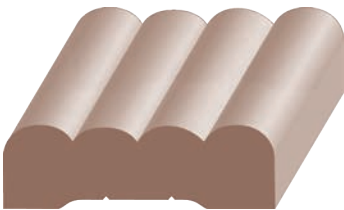

112SP 1/2 x 1-5/8
Solid Pine 4-Bead Casing S



113SP 1/2 x 1-5/8
Solid Pine #1550 Casing S

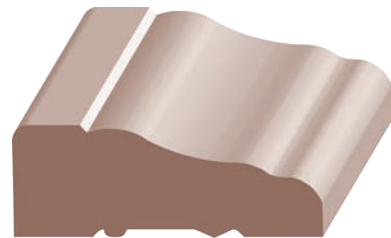

130SP 5/8 x 1-5/8
Solid Pine Moulded Casing N

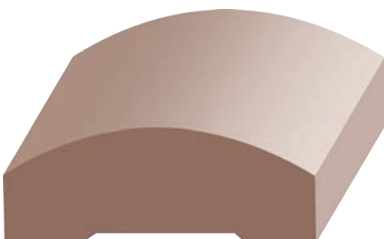

142SP 9/16 x 1-5/8
Solid Pine Oval Casing N



2" to 2-1/4" Casing

lengths available: 7' thru 16'

(arranged in order of width; items are approximate scale only)



121SP 5/8 x 2
Solid Pine Clamshell Casing **S**

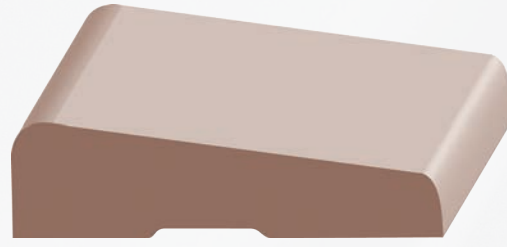

103BSP 5/8 x 2-1/4
Solid Pine Beveled Casing **N**

103SP 5/8 x 2-1/2
Solid Pine Streamline Casing **S**



106BSP 5/8 x 2-1/4
Solid Pine Oval Casing **N**

106SP 5/8 x 2-1/2
Solid Pine Streamline Casing **S**



110BSP 5/8 x 2-1/4
Solid Pine 3-Step Casing **N**

110SP 5/8 x 2-1/2
Solid Pine 3-Step Casing **S**



120BSP 9/16 x 2-1/4
Solid Pine 2 Round Edge Casing **N**

120SP 5/8 x 2-1/2
Solid Pine 2 Round Edge Casing **S**

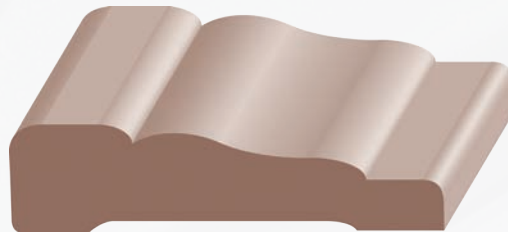

141SP 5/8 x 2-1/4
Solid Pine Moulded Casing **N**

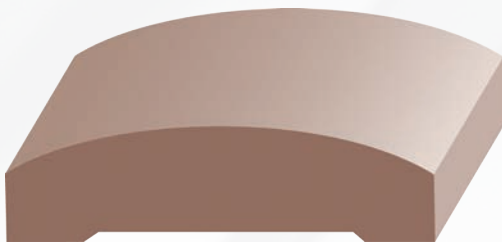

143SP 9/16 x 2-1/4
Solid Pine Oval Casing **N**



152SP 11/16 x 2-1/4
Solid Pine Colonial/#356 Casing **N/S**
Also Available in Pre-packaged Sets

2-1/2" to 2-5/8" Casing

lengths available: 7' thru 16'

(arranged in order of width; items are approximate scale only)

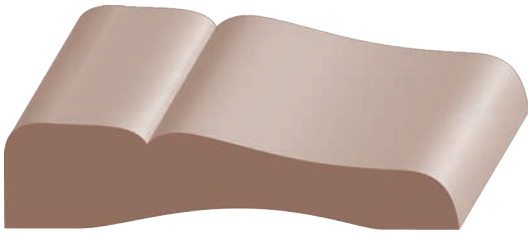

108SP 5/8 x 2-1/2
Solid Pine #711 Casing **S**

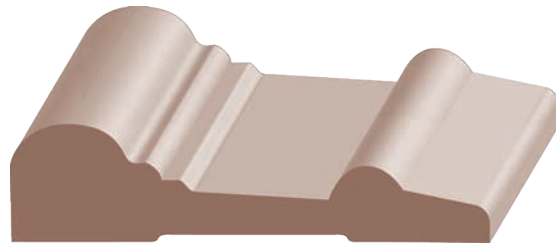

115SP 5/8 x 2-1/2
Solid Pine Universal Casing **S**

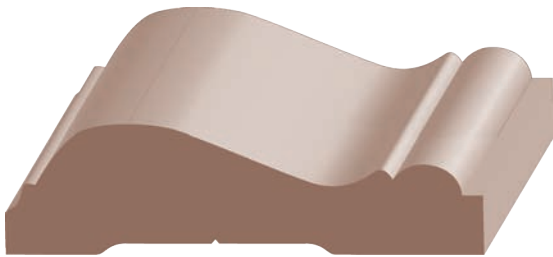

116SP 11/16 x 2-1/2
Solid Pine Colonial Casing **S**

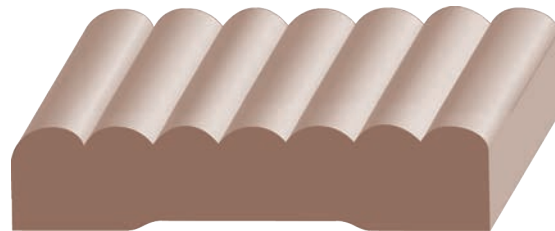

122SP 5/8 x 2-1/2
Solid Pine 7-Bead Casing **S**

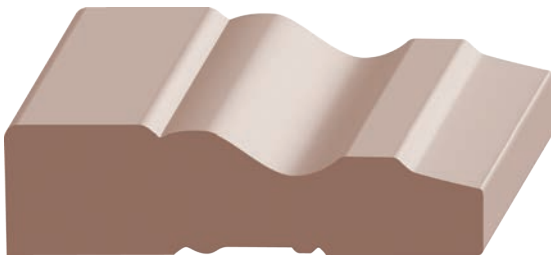

131SP 11/16 x 2-1/2
Solid Pine Riviera Casing **N**

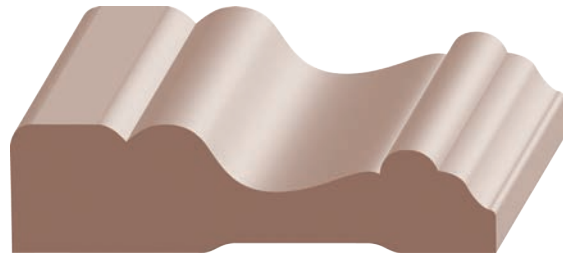

150SP 5/8 x 2-1/2
Solid Pine Cape Cod Casing **N/S**

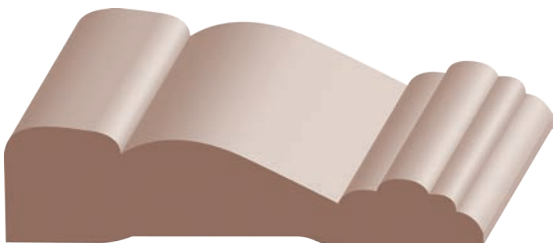

169SP 11/16 x 2-1/2 Victorian Casing **N**

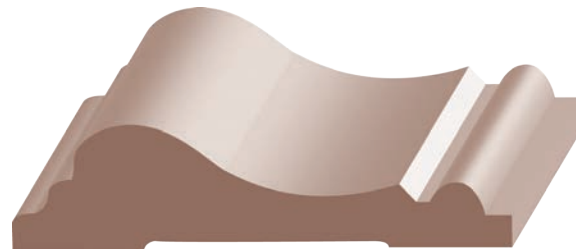

145SP 5/8 x 2-5/8 Coronado Casing / Chair Rail **N**



2-7/8" to 3-1/4" Casing

lengths available: 8" thru 16"

(arranged in order of width; items are approximate scale only)

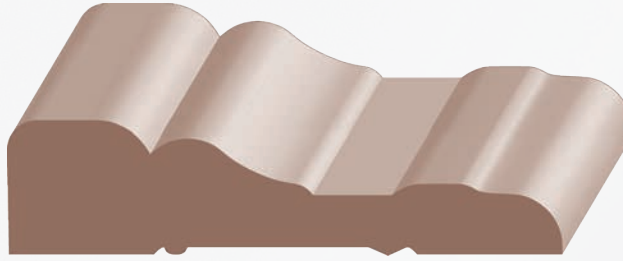

119SP 11/16 x 2-7/8
Solid Pine Colonial Casing S



139SP 9/16 x 3-1/4
Solid Pine 2 Round Edge Casing N/S

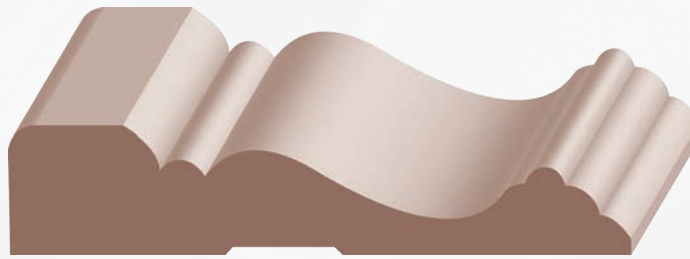

155BSP 11/16 x 3-1/4
Solid Pine Cape Cod Casing N

155SP 11/16 x 3-1/2
Solid Pine Cape Cod Casing S



176SP 5/8 x 3-1/4
Solid Pine Moulded Casing N/S



(arranged in order of width; items are approximate scale only)

3-1/4" to 4-1/4" Casing

lengths available: 7' thru 16'

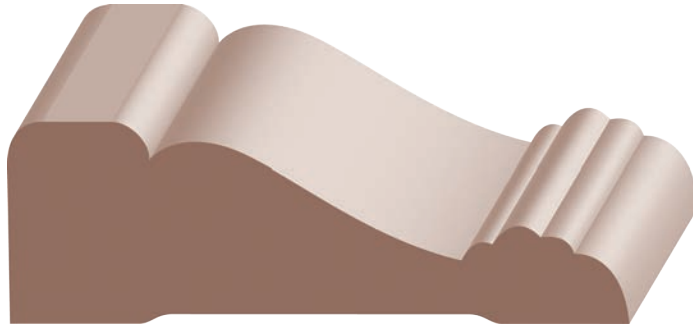

186SP 1 x 3-1/4
Solid Pine 49er Casing N



114SP 1/4 x 3-1/2
Solid Pine 2 Eased Edge Mullion Casing S

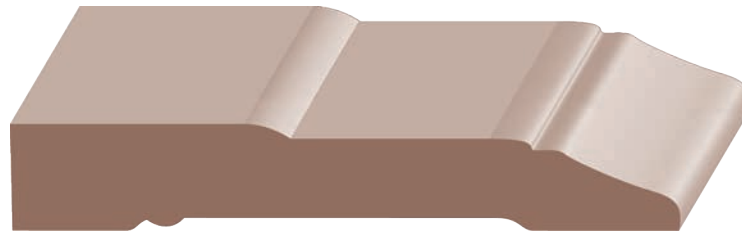

117SP 9/16 x 3-1/2
Solid Pine Colonial Casing/Base S
(use with 190SP to create a wider casing)



118SP-4 9/16 x 4-1/4
Solid Pine Colonial Casing/Base S
(use with 190SP to create a wider casing)

Window & Door Stop

lengths available: 7' thru 16'

(arranged in order of width; items are approximate scale only)

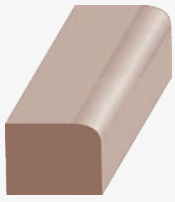

200SP 3/8 x 1/2
Solid Pine
1 Round Edge Stop **S**

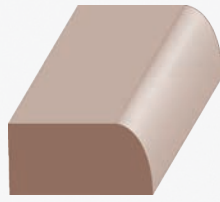

213SP 3/8 x 3/4
Solid Pine
1 Round Edge Stop **S**

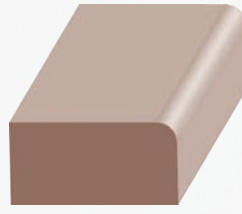

212SP 7/16 x 7/8
Solid Pine
1 Round Edge Stop **N**

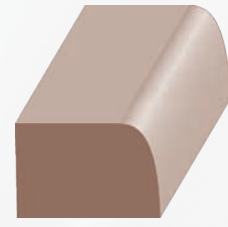

204SP 1/2 x 3/4
Solid Pine
1 Round Edge Stop **S**

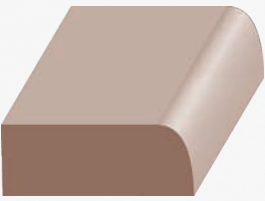

208SP 3/8 x 1
Solid Pine
1 Round Edge Stop **S**

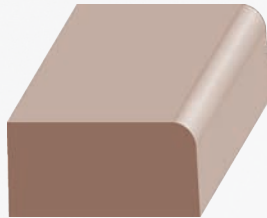

205SP 1/2 x 1
Solid Pine
1 Round Edge Stop **S**

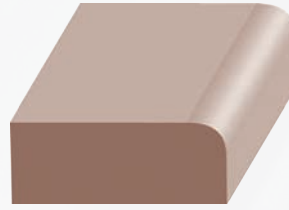

214SP 7/16 x 1-1/8
Solid Pine
1 Round Edge Stop **N**

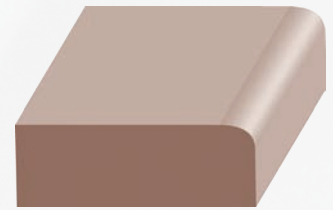

201SP 7/16 x 1-1/4
Solid Pine
1 Round Edge Stop **N**



202SP 3/8 x 1-1/4
Solid Pine
1 Round Edge Stop **S**

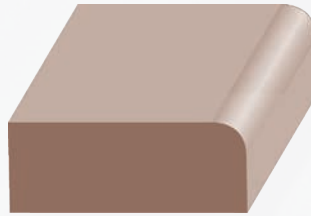

206SP 1/2 x 1-1/4
Solid Pine
1 Round Edge Stop **S**

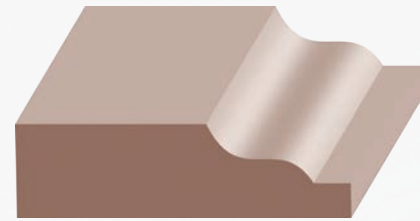

210BSP 7/16 x 1-3/8
Solid Pine
Colonial Stop **N**

210SP 1/2 x 1-3/4
Solid Pine
Ogee Stop **S**



216SP 7/16 x 1-3/8
Solid Pine
1 Round Edge Stop **N**

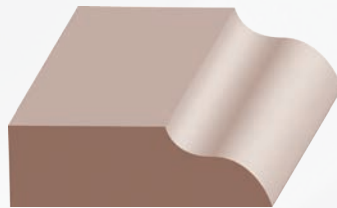

219SP 7/16 x 1-3/8
Solid Pine
Ogee Stop **N/S**



203SP 3/8 x 1-5/8
Solid Pine
1 Round Edge Stop **S**



207SP 1/2 x 1-5/8
Solid Pine
1 Round Edge Stop **S**



217SP 7/16 x 1-5/8
Solid Pine
1 Round Edge Stop **N**



218SP 7/16 x 2-1/4
Solid Pine
1 Round Edge Stop **N**



3/4" to 2-1/4" Base, Shoe & Cap

lengths available: 8' thru 16'

(arranged in order of width; items are approximate scale only)

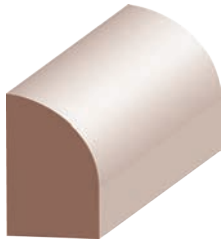

300BSP 1/2 x 3/4
Solid Pine Base Shoe **N/S**

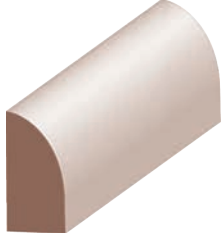

300ASP 3/8 x 3/4
Solid Pine Base Shoe **S**

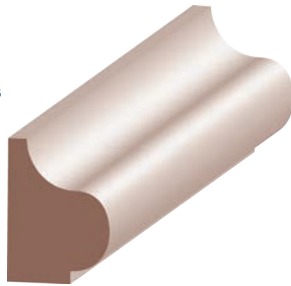

615SP 9/16 x 3/4
Solid Pine Base Cap **N**

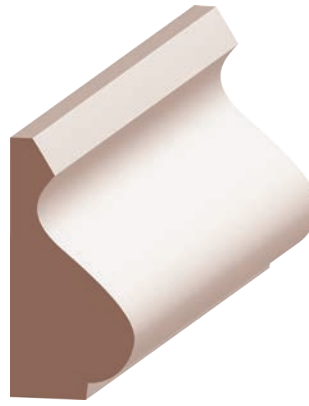

614SP 11/16 x 1-3/8
Solid Pine
Coronado Base Cap **N/S**

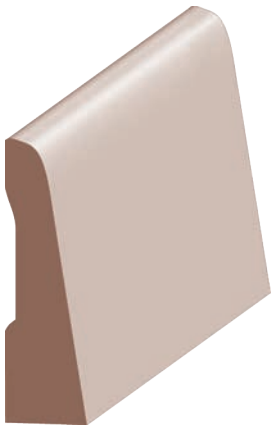
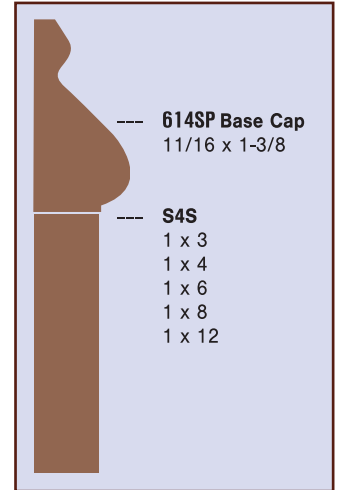

301SP 7/16 x 1-1/2
Solid Pine
Flat Base/Apron **S**

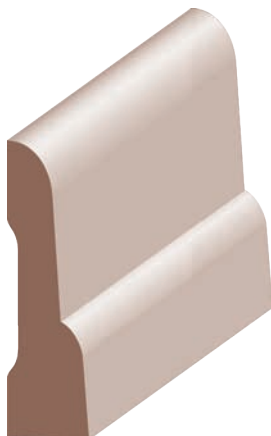

308SP 7/16 x 1-9/16
Solid Pine Combo
Base & Shoe **S**

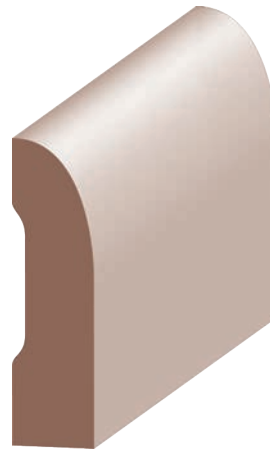

302SP 7/16 x 1-5/8
Solid Pine
Streamline Base **S**

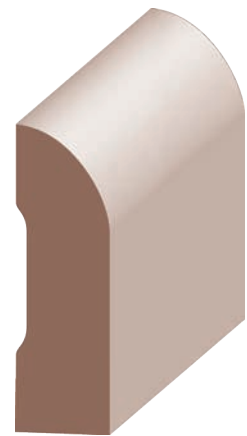

303SP 1/2 x 1-5/8
Solid Pine
Streamline Base **S**

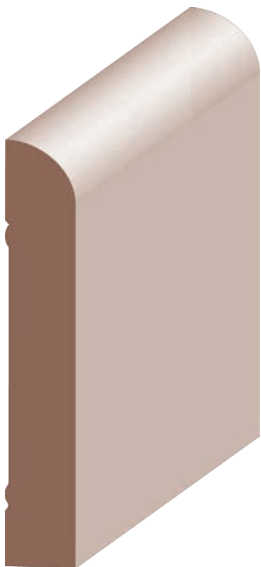

304SP 3/8 x 2-1/4
Solid Pine
Streamline Base **S**



306BSP 1/2 x 2-1/4
Solid Pine
Streamline Base **N**

306SP 1/2 x 2-1/2
Solid Pine
Streamline Base **S**

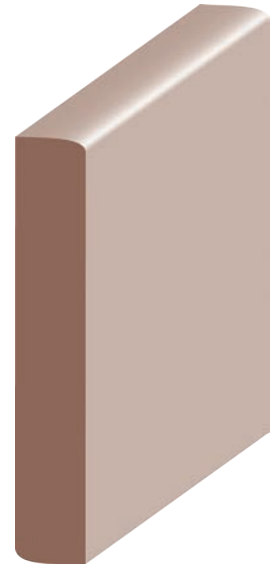

R304SP-2 3/8 x 2-1/4
Reversible Base **N**



2-1/4" to 2-1/2" Base

lengths available: 8" thru 16"

(arranged in order of width; items are approximate scale only)

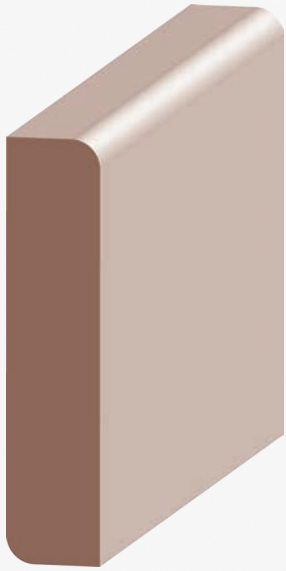

R306SP-2 1/2 x 2-1/4
Solid Pine
Reversible Base **N**

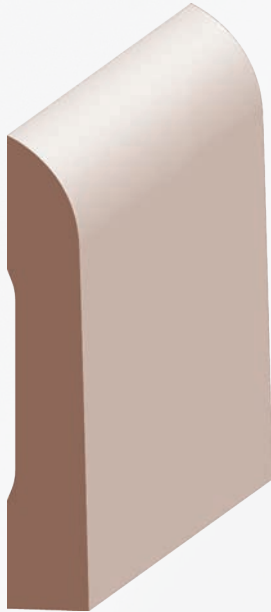

305SP 7/16 x 2-1/2
Solid Pine
Streamline Base **S**

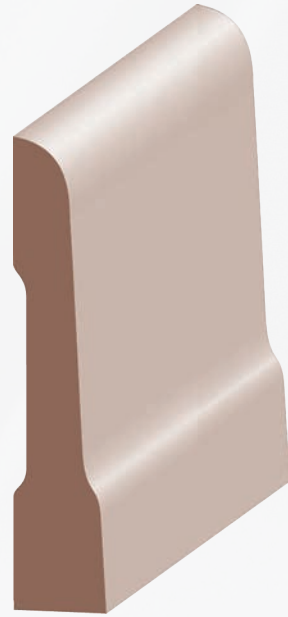

309SP 1/2 x 2-1/2
Solid Pine
Combo Base & Shoe **S**



310SP 1/2 x 2-1/2
Solid Pine
#711 Base **S**

310SP-SC 7/16 x 2-1/2
Solid Pine Scant
#711 Base **S**

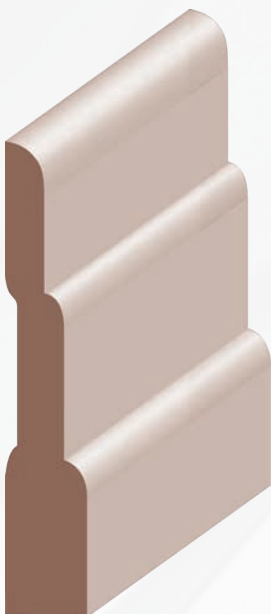

321SP-2 1/2 x 2-1/2
Solid Pine 3-Step Base **S**
(FORMERLY 312SP-2)

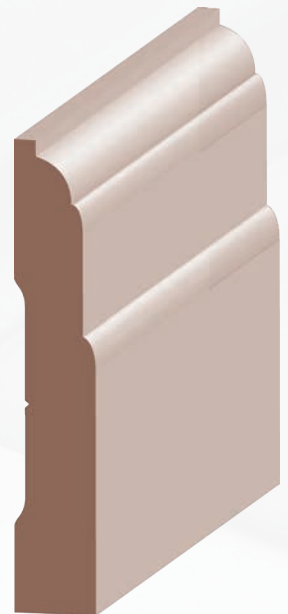

313SP 7/16 x 2-1/2
Solid Pine #1550 Base **S**

3-1/4" to 3-1/2" Base

lengths available: 8' thru 16'

(arranged in order of width; items are approximate scale only)

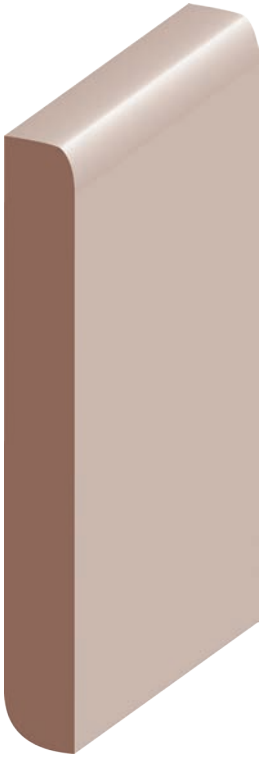

R304SP-3 3/8 x 3-1/4
Solid Pine Reversible Base **N**

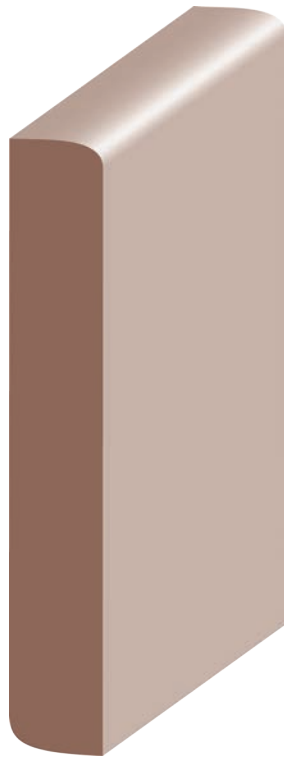

R306SP-3 1/2 x 3-1/4
Solid Pine Reversible Base **N**

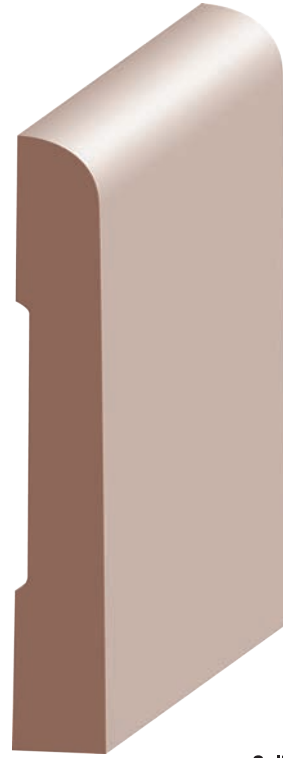

307BSP 1/2 x 3-1/4
Solid Pine Streamline Base **N**

307SP 7/16 x 3-1/2
Solid Pine Streamline Base **S**

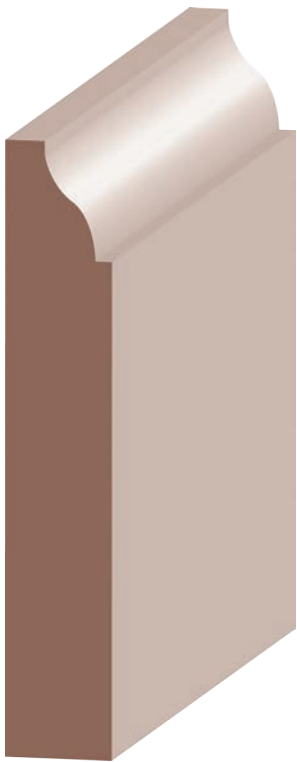

314SP-3 9/16 x 3-1/4
Solid Pine Coronado/#623 Base **N/S**

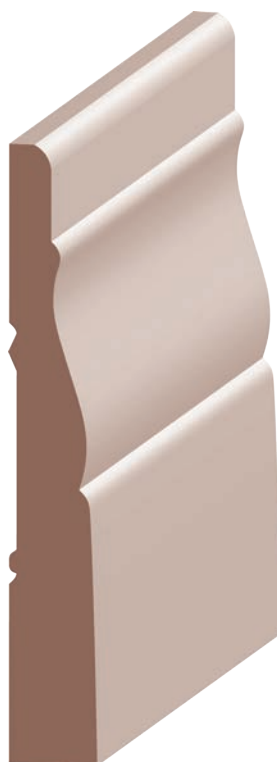

320SP 1/2 x 3-1/4
Solid Pine Colonial/#356 Base **N/S**

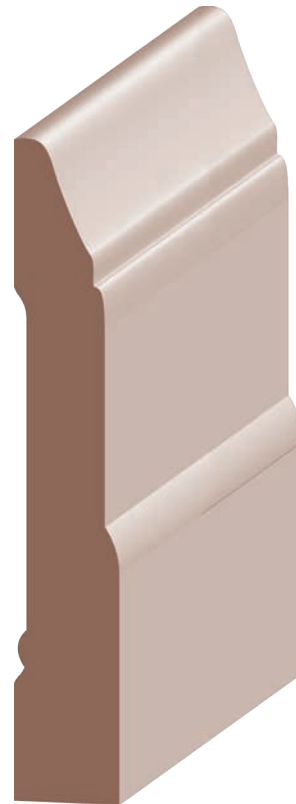

117SP 9/16 x 3-1/2
Solid Pine Colonial Base/Casing **S**



3-1/2" to 4-1/4" Base

lengths available: 8' thru 16'

(arranged in order of width; items are approximate scale only)

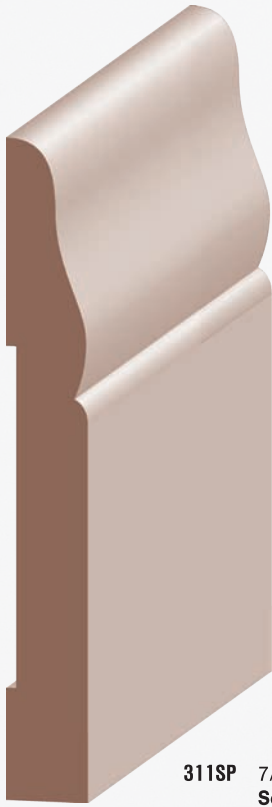

311SP 7/16 x 3-1/2
Solid Pine #711 Base **S**



321SP-3 1/2 x 3-1/2
Solid Pine 3 Step Base **N/S**

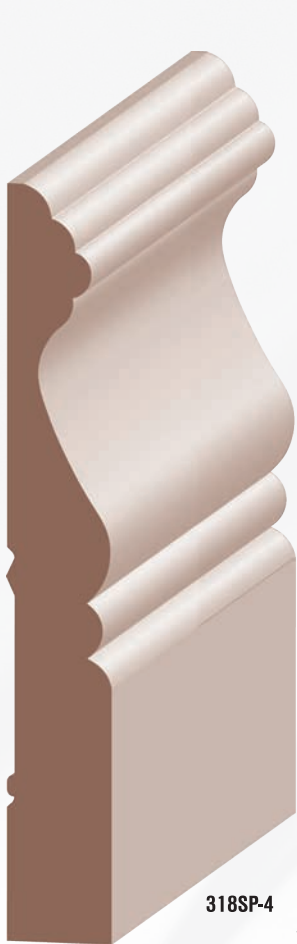

318SP-4 9/16 x 4
Solid Pine
Cape Cod Base **S**

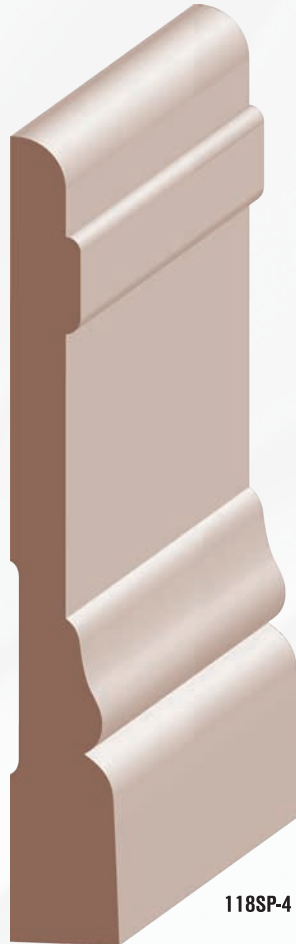

118SP-4 9/16 x 4-1/4
Solid Pine
Colonial Base/Casing **S**



(arranged in order of width; items are approximate scale only)

5-1/4" to 5-1/2" Base

lengths available: 8' thru 16'

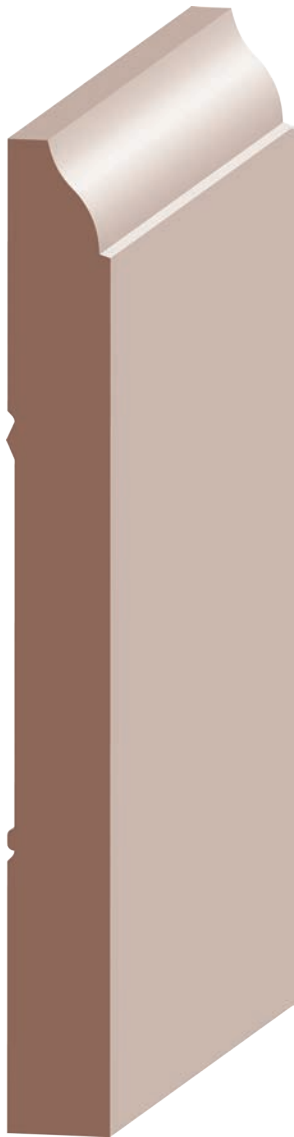

314SP-5 9/16 x 5-1/4
Solid Pine Coronado/#618 Base **N/S**



318SP-5 9/16 x 5-1/4
Solid Pine Cape Cod Base **N/S**

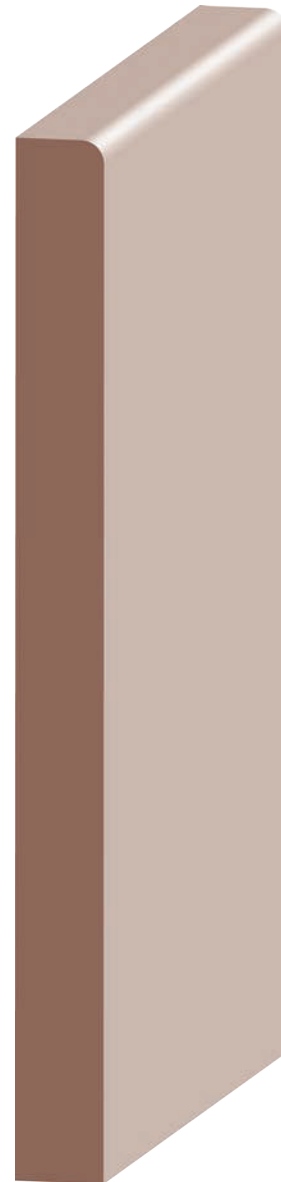

387SP-5 1/2 x 5-1/2
Solid Pine 1 Eased Edge
Craftsman Base **N/S**

1-5/8" to 3-5/8" Crown

lengths available: 8" thru 16"

(arranged in order of width; items are approximate scale only)

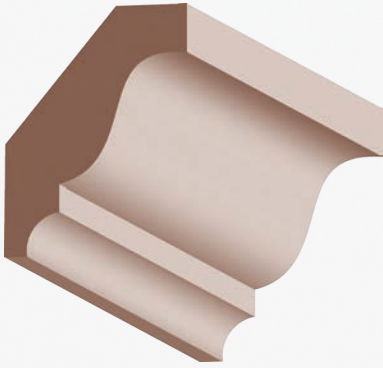

400SP 9/16 x 1-5/8 **Solid Pine Colonial Crown** **N**

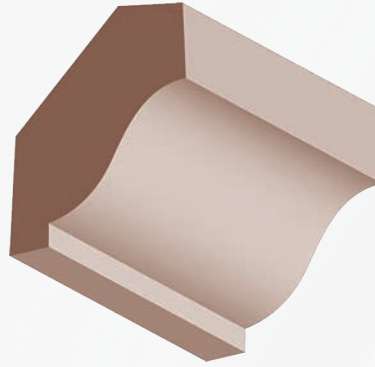

401SP-1 9/16 x 1-5/8 **Solid Pine Crown** **S**
(FORMERLY E400)

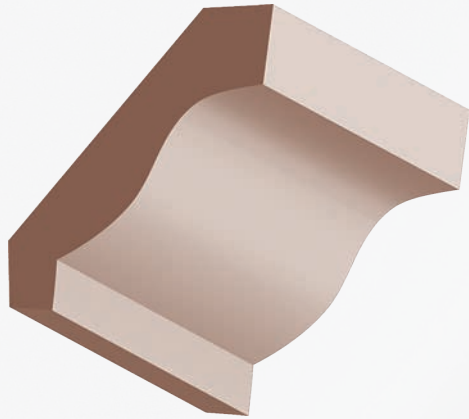

401SP-2 9/16 x 2-1/4 **Solid Pine Crown** **S**
(FORMERLY E401)

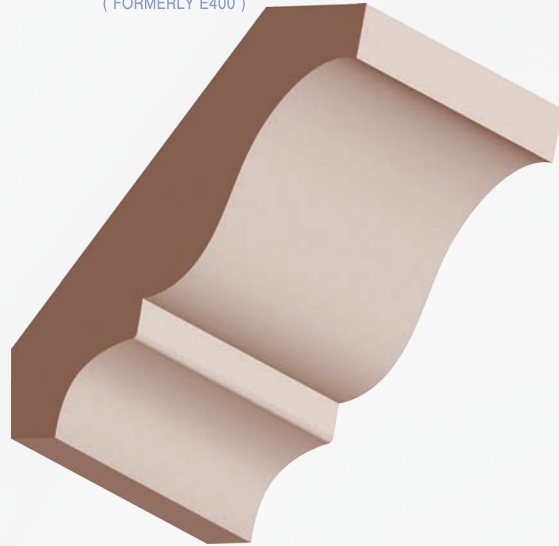

436SP 9/16 x 2-3/4 **Solid Pine Colonial Crown** **N**

418SP 9/16 x 2-1/4 **Solid Pine Colonial Crown** **S**

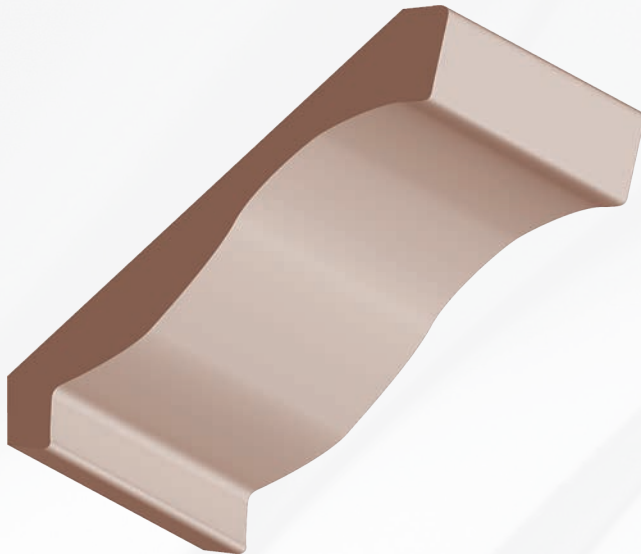

401SP-3 9/16 x 3-1/2 **Solid Pine Crown** **S**

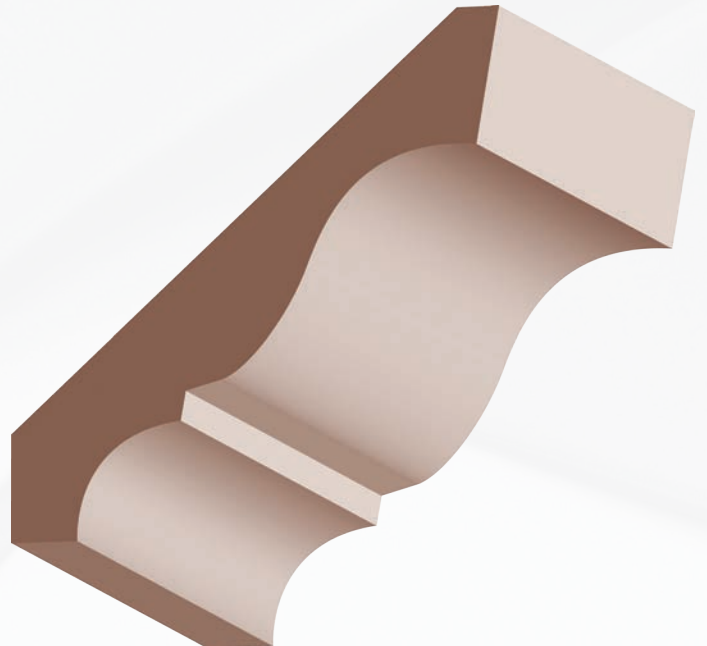

405BSP 9/16 x 3-5/8 **Solid Pine Colonial Crown** **N**

405SP 9/16 x 3-3/8 **Solid Pine Colonial Crown** **S**



(arranged in order of width; items are approximate scale only)

4-1/4" to 4-1/2" Crown

lengths available: 8' thru 16'

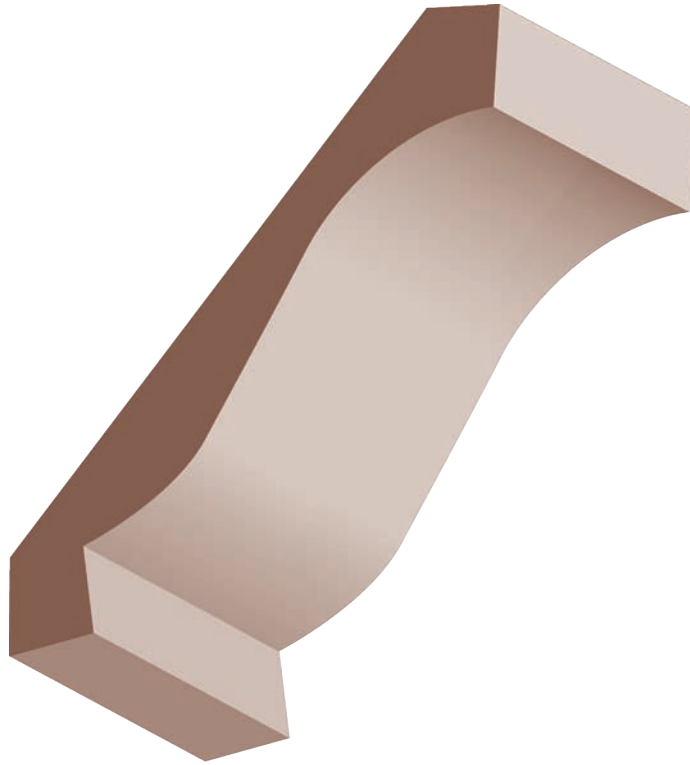

403SP 9/16 x 4-1/4
Solid Pine Crown **S**

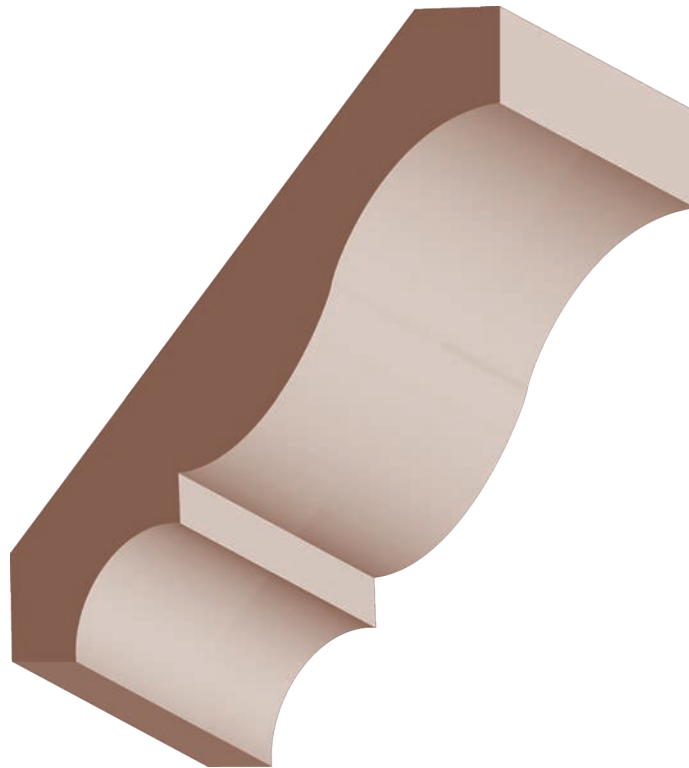

406SP 9/16 x 4-1/2
Solid Pine Colonial Crown **N/S**

4-1/2" to 5-1/4" Crown

lengths available: 8' thru 16'

(arranged in order of width; items are approximate scale only)

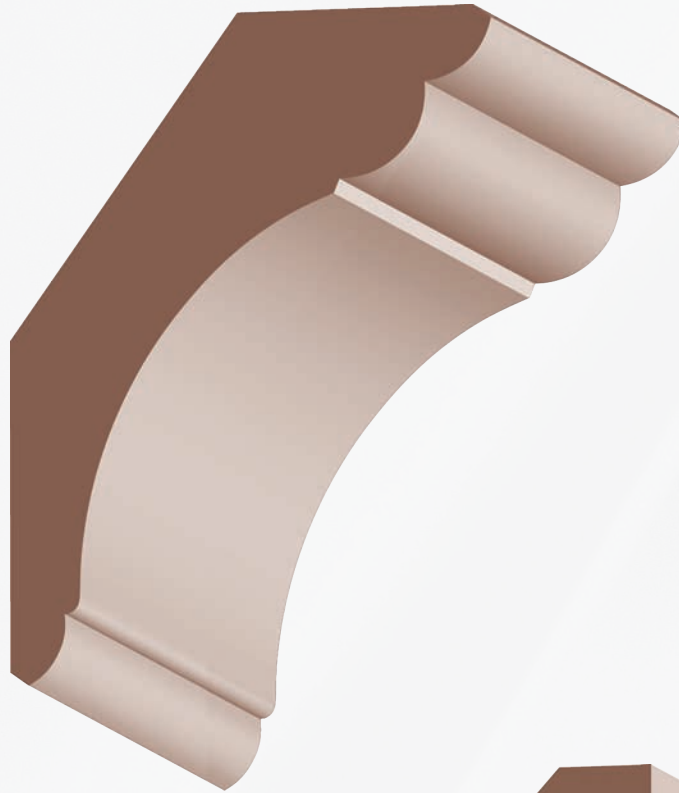

407SP 1-1/8 x 4-1/2
Solid Pine Cornice **S**

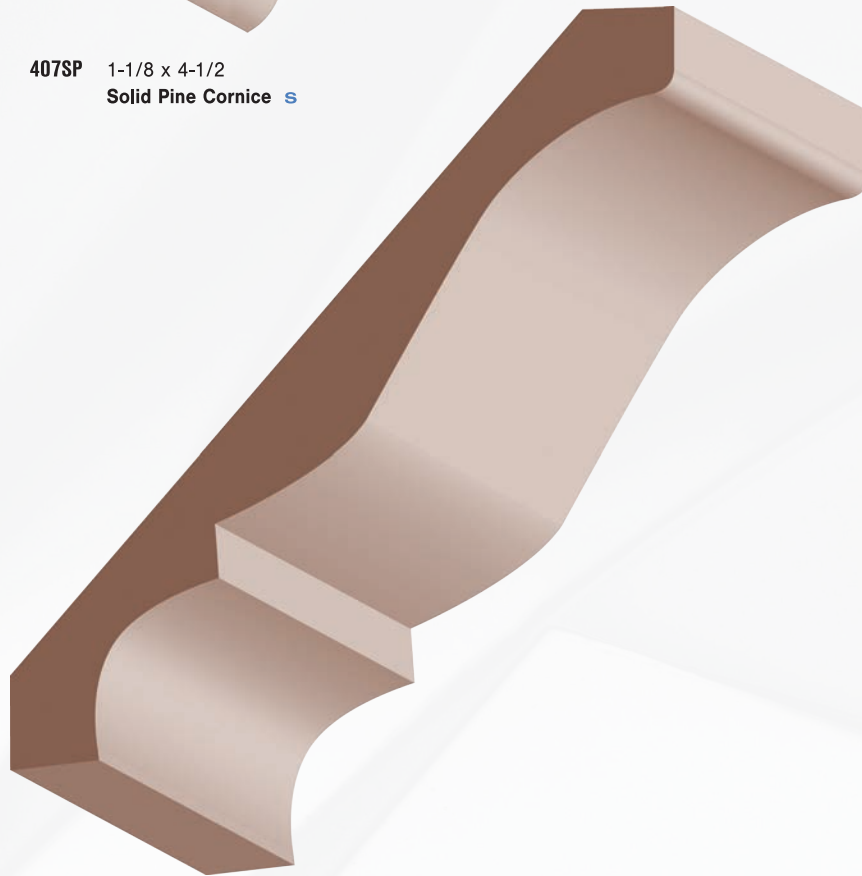

414SP 9/16 x 5-1/4
Solid Pine Colonial Crown **N/S**

(arranged in order of width; items are approximate scale only)

5-1/2" to 6" Crown

✦ lengths available: 8' thru 16'

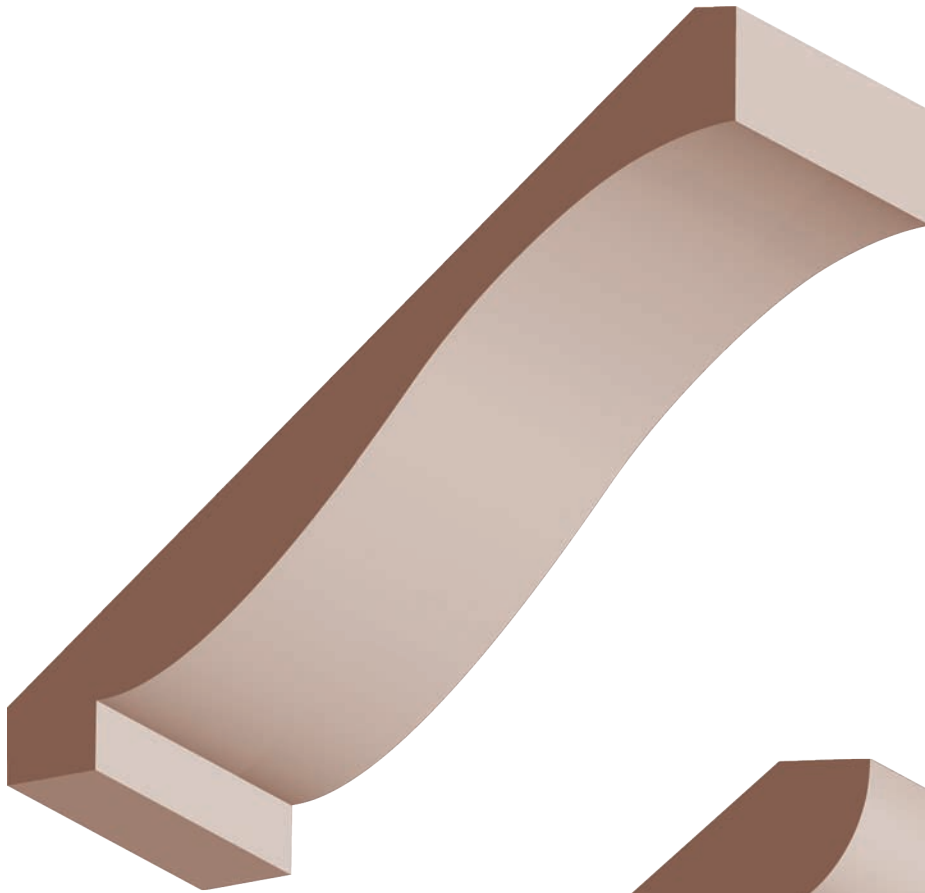

404SP 9/16 x 5-1/2
Solid Pine Crown **S**

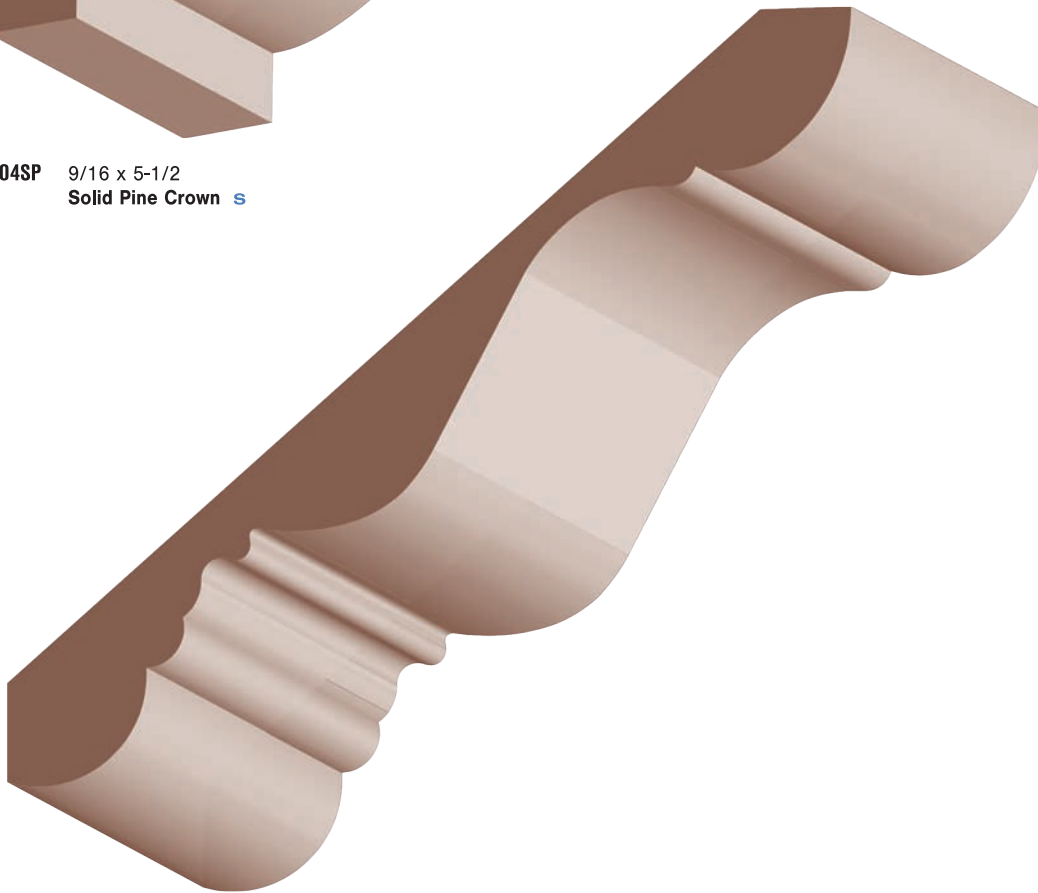

410SP-6 11/16 x 6
Solid Pine Charleston Crown **S**

Half Round

✂ lengths available: 8' thru 16'



- Solid Pine Half Round**
- 570SP 1/4 x 1/2 **N/S**
 - 571SP 5/16 x 5/8 **N/S**
 - 572SP 3/8 x 3/4 **N/S**
 - 573SP 1/2 x 1 **N/S**
 - 574SP 5/8 x 1-1/4 **S**

Quarter Round

✂ lengths available: 8' thru 16'



- Solid Pine Quarter Round**
- 500SP 1/4 x 1/4 **N/S**
 - 501SP 3/8 x 3/8 **N/S**
 - 502SP 1/2 x 1/2 **N/S**
 - 503SP 5/8 x 5/8 **N/S**
 - 504SP 3/4 x 3/4 **N/S**
 - 505SP 1 x 1 **N/S**

(arranged in order of width; items are approximate scale only)

Cove

✂ lengths available: 8' thru 16'



- 520SP 3/8 x 3/8
Solid Pine Cove S

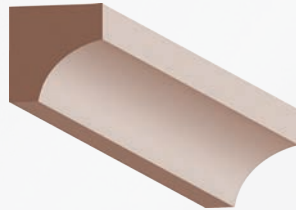

- 521SP 1/2 x 1/2
Solid Pine Cove N/S

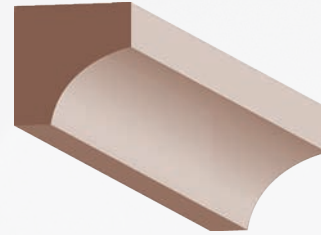

- 522SP 5/8 x 5/8
Solid Pine Cove S

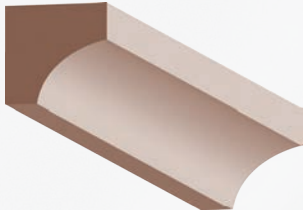

- 523SP 3/4 x 3/4
Solid Pine Cove N/S

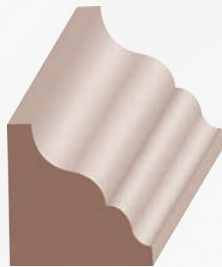

- 528SP 3/4 x 3/4
Solid Pine Decorative Cove N

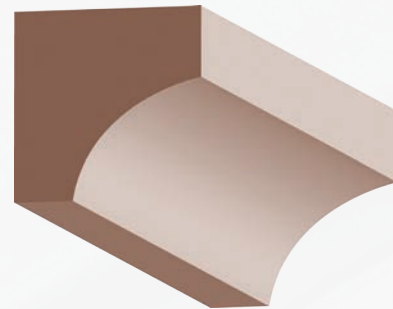

- 524SP 1 x 1
Solid Pine Cove N/S



- 527BSP 5/8 x 1-1/2
Solid Pine Linoleum Cove N

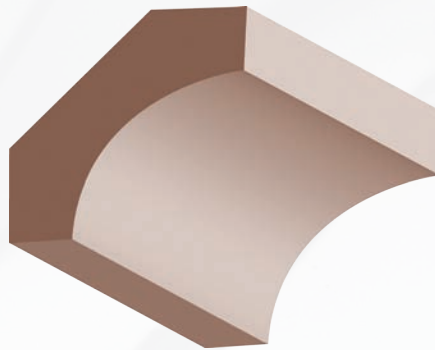

- 525BSP 11/16 x 1-3/4
Solid Pine Sprung Cove N

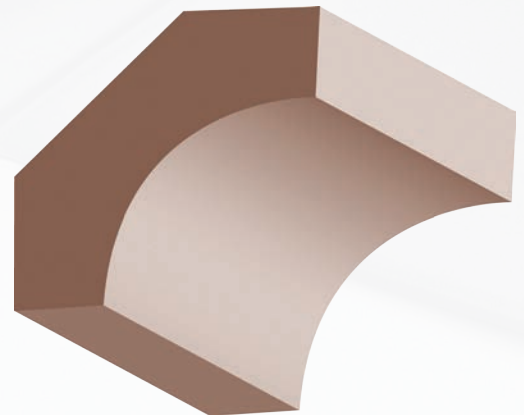

- 526SP 5/8 x 2-1/4
Solid Pine Sprung Cove N/S

- 527SP 7/16 x 1-1/4
Solid Pine Linoleum Cove S

- 525SP 5/8 x 1-5/8
Solid Pine Sprung Cove S

(arranged in order of width; items are approximate scale only)

Screen / Scribe / Bead

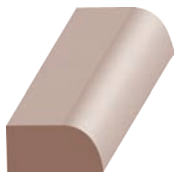

590SP 3/16 x 1/2
Solid Pine Insert **N/S**



591SP 1/4 x 3/4
Solid Pine Flat Screen Mold **N/S**

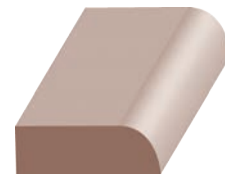

593SP 3/16 x 3/4
Solid Pine Scribe Mold **N/S**

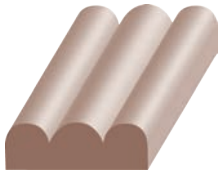

592SP 1/4 x 3/4
Solid Pine Beaded Screen Mold **N/S**



597SP 3/8 x 3/8
Solid Pine Glass Bead **N/S**

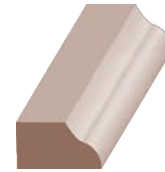

596SP 1/4 x 7/16
Solid Pine Glass Bead **S**

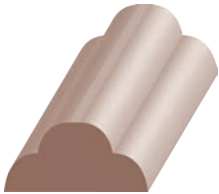

594SP 3/8 x 3/4
Solid Pine Cloverleaf **N/S**

Chair Rail

lengths available: 8" thru 16"

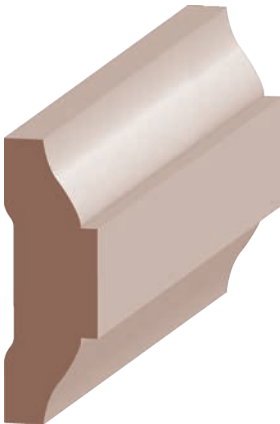

650SP 1/2 x 1-1/2
Solid Pine Chair Rail **S**



651BSP 9/16 x 2
Solid Pine Chair Rail **N**

651SP 9/16 x 2-1/2
Solid Pine Chair Rail **S**



145SP 5/8 x 2-5/8
Solid Pine Coronado Casing/Chair Rail **N**

652SP 11/16 x 2-1/2
Solid Pine Colonial Chair Rail **S**



Astragal

(arranged in order of width; items are approximate scale only)

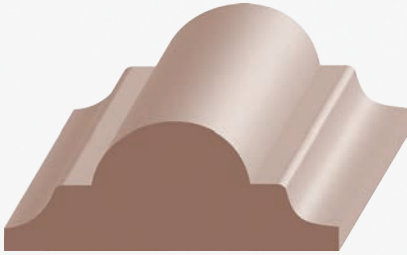

646SP 11/16 x 1-5/8
Solid Pine Flat Astragal/Panel Mold **N**

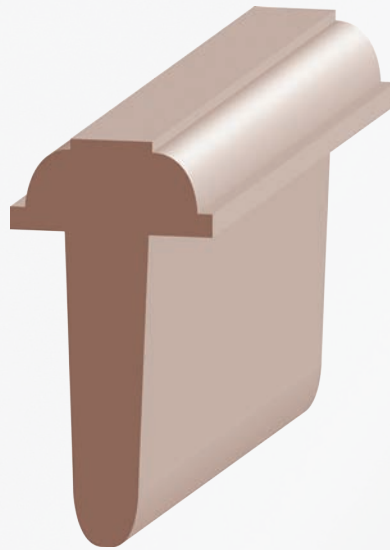

662SP 1-1/4 x 2
Solid Pine T-Astragal **N/S**
 (for 1-3/8" Door)

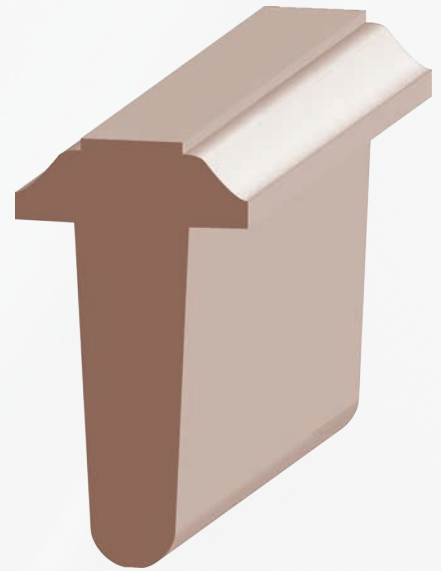

661SP 1-1/4 x 2-1/4
Solid Pine T-Astragal **S**
 (for 1-3/4" Doors)

lengths available: 7' thru 16'

lengths available: 7' and 8' only

lengths available: 7' & 8' only

Panel Cap

lengths available: 8' thru 16' only

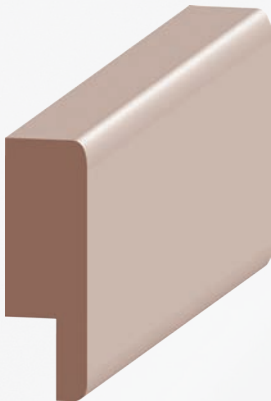

623SP 7/16 x 1-3/8
Solid Pine Wainscot Cap **N**
 [with 3/8" Rab't]

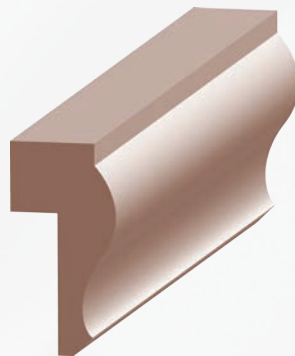

624SP 9/16 x 1-1/8
Solid Pine Panel Cap **N**
 [with 1/4" x 3/8" Rab't]

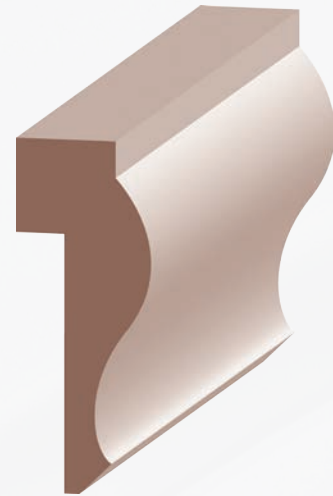

625SP 3/4 x 2
Solid Pine Large Panel Cap **N**
 [with 1/4" x 1-1/8" Rab't]

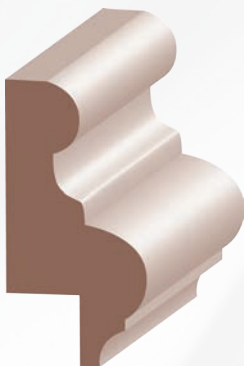

620SP 3/4 x 1-1/2
Solid Pine Panel Cap **N/S**
 [with 3/8" Rab't]



Panel & Decorative

lengths available: 8' thru 16'

(arranged in order of width; items are approximate scale only)

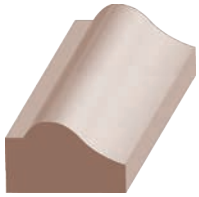

600SP 3/8 x 5/8
Solid Pine Panel Mold **N/S**

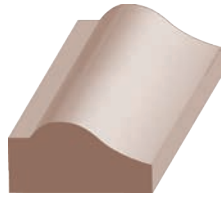

601SP 5/8 x 3/4
Solid Pine Panel Mold **N/S**

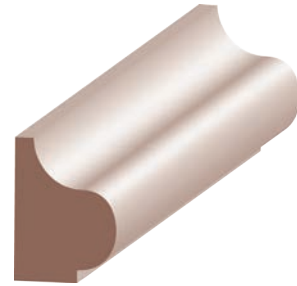

615SP 9/16 x 3/4
Solid Pine Base Cap **N**

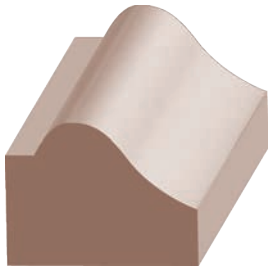

602SP 3/4 x 1
Solid Pine Panel Mold **N/S**

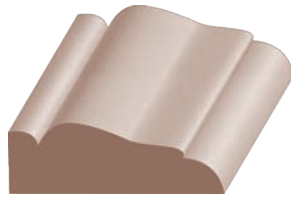

604SP 3/8 x 1-1/8
Solid Pine Panel Mold **S**

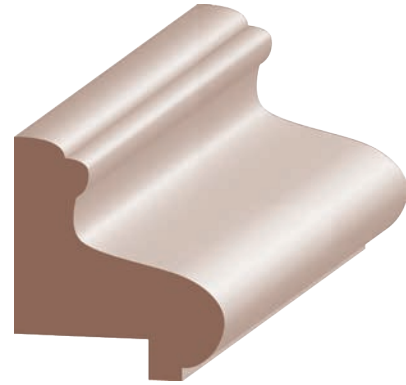

613SP 1-1/8 x 1-1/4
Solid Pine Raised Panel Cap **N/S**
[with 1/4" x 3/4" Rab't]

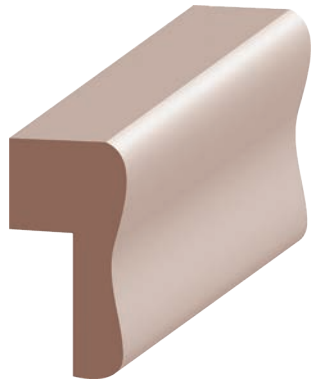

731SP 5/8 x 1-1/4
Solid Pine Wainscot Cap **S**
[with 1/4" Rab't]

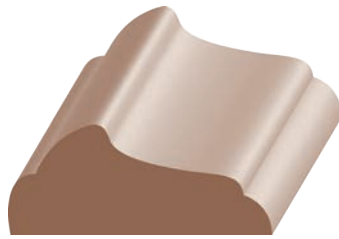

606SP 9/16 x 1-3/8
Solid Pine Panel Mold **N/S**

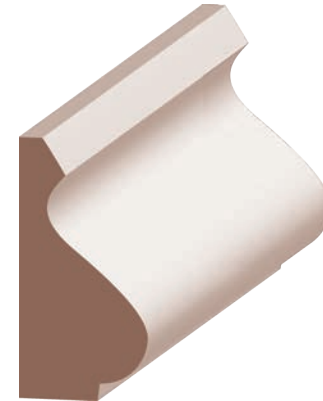

614SP 11/16 x 1-3/8
Solid Pine Coronado Base Cap/Panel Cap **N/S**

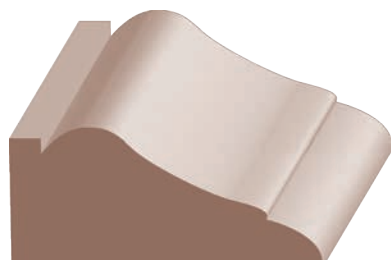

605SP 3/4 x 1-5/8
Solid Pine Panel Mold **N/S**

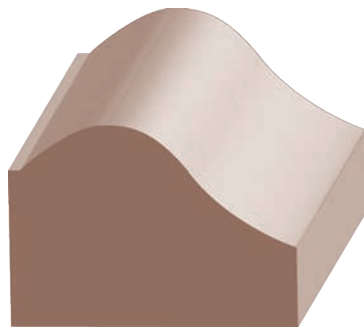

603SP 1-1/16 x 1-1/2
Solid Pine Panel/Brick Mold **S**

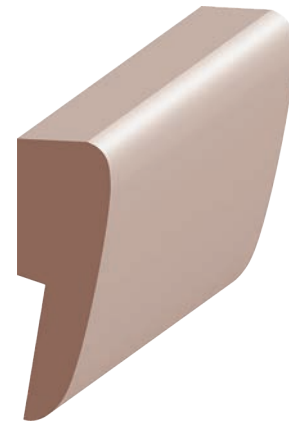

730SP 1/2 x 1-1/2
Solid Pine Panel Cap **S**
[with 1/8" Rab't]



Panel & Decorative

(arranged in order of width; items are approximate scale only)



607SP 5/8 x 1-5/8
Solid Pine Beauty Mold **S**

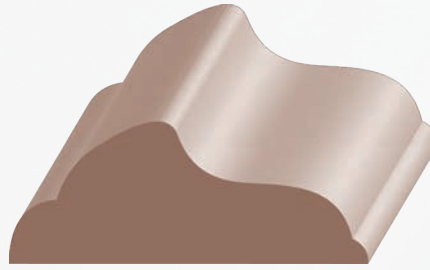

608SP 3/4 x 1-7/8
Solid Pine Beauty Mold **S**

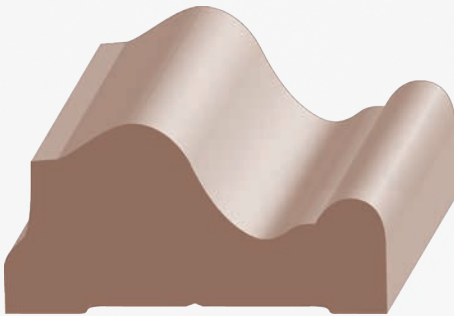

610SP 1 x 2
Solid Pine Decorative Panel Mold **S**



611SP 1-3/8 x 3-1/4
Solid Pine Decorative Panel Mold **S**

Outside Corner Guard

lengths available: 8" thru 16"

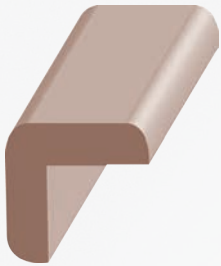

720SP 3/4 x 3/4
Solid Pine Outside Corner Guard **N/S**

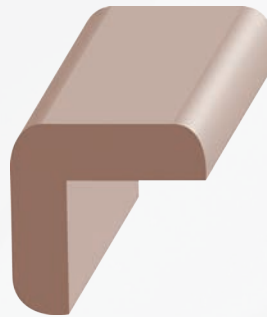

721SP 1 x 1
Solid Pine Outside Corner Guard **N/S**

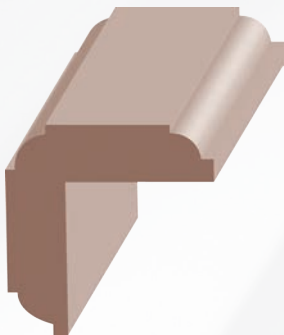

723SP 1-1/8 x 1-1/8
Solid Pine Decorative Outside Corner Guard **N/S**

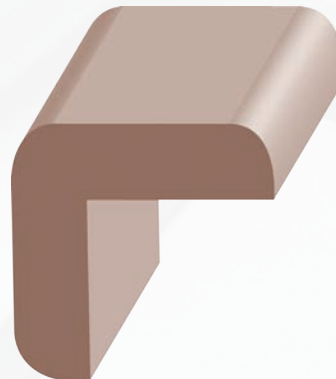

722SP 1-3/8 x 1-3/8
Solid Pine Outside Corner Guard **N/S**

(arranged in order of width; items are approximate scale only)

Lattice / S4S / Full Round

lengths available: 8' thru 16'



Solid Pine Lattice

| | | |
|---------------|-------------|-----|
| 700SP | 1/4 x 1-1/8 | N/S |
| 701SP | 1/4 x 1-1/4 | S |
| 701BSP | 1/4 x 1-3/8 | N |
| 702SP | 1/4 x 1-5/8 | S |
| 702BSP | 1/4 x 1-3/4 | N |
| 703SP | 1/4 x 2-1/2 | S |
| 703BSP | 1/4 x 2-1/4 | N |
| 704SP | 1/4 x 3-1/2 | N/S |

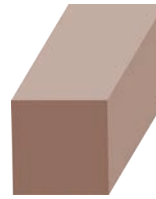

| | | | | |
|--------------|-----------------|--------|----------------------|-----|
| 705SP | 1/2 x 1/2 | | S4S | N/S |
| 706SP | 1/2 x 3/4 | | S4S | N/S |
| 707SP | 1/2 x 1-1/2 | | S4S | N/S |
| 708SP | 1/2 x 2-1/2 | | S4S | N/S |
| 709SP | 1/2 x 3-1/2 | | S4S | N/S |
| 710SP | 1/2 x 5-1/2 | | S4S | N/S |
| 711SP | 3/4 x 3/4 | | S4S | N/S |
| 712SP | 11/16 x 1-1/4 | | S4S | S |
| 713SP | 11/16 x 1-5/8 | (1x2) | S4S | N/S |
| 714SP | 11/16 x 2-1/2 | (1x3) | S4S | N/S |
| 715SP | 11/16 x 3-1/2 | (1x4) | S4S | N/S |
| 716SP | 1 x 1 | (1x1) | S4S | N/S |
| 717SP | 1-9/16 x 1-9/16 | (2x2) | S4S | N/S |
| 719SP | 1-1/2 x 1-1/2 | (2x2) | 4EE S4S | S |
| 750SP | 3/4 x 5-1/2 | (1x6) | C&BTR S4S | N/S |
| 751SP | 3/4 x 7-1/4 | (1x8) | C&BTR S4S | N/S |
| 752SP | 3/4 x 9-1/4 | (1x10) | C&BTR S4S | S |
| 753SP | 3/4 x 11-1/4 | (1x12) | C&BTR S4S | N/S |
| 715KP | 3/4 x 3-1/2 | (1x4) | #2 COMMON S4S | N |
| 750KP | 3/4 x 5-1/2 | (1x6) | #2 COMMON S4S | N |
| 751KP | 3/4 x 7-1/4 | (1x8) | #2 COMMON S4S | N |
| 752KP | 3/4 x 9-1/4 | (1x10) | #2 COMMON S4S | N |
| 753KP | 3/4 x 11-1/4 | (1x12) | #2 COMMON S4S | N |
| 758KP | 1-1/2 x 11-1/4 | (2x12) | #2 COMMON S4S | N |

Full Round

lengths available: 6' - 16'

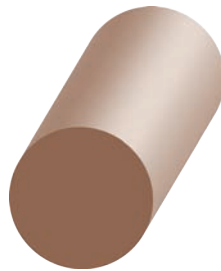

Solid Pine Full Round

| | | |
|--------------|--------|-----|
| 800SP | 3/4" | N |
| 801SP | 1" | N |
| 802SP | 1-1/4" | N/S |
| 803SP | 1-3/8" | S |
| 807SP | 1-5/8" | N |

Exterior Molds

lengths available: 7' thru 16'

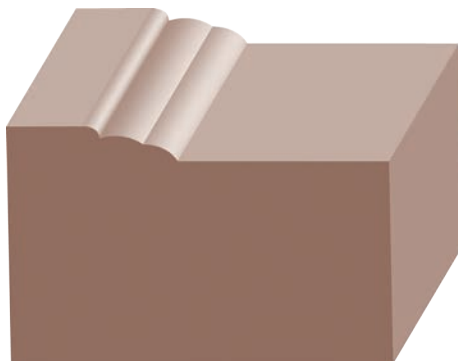

612ASP 1-1/4 x 2
Solid Pine #180 Eastern Brick Mold N/S
 without Stucco Key

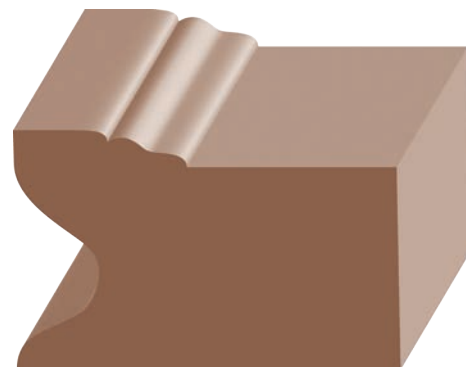

612BSP 1-1/4 x 2
Solid Pine #180 Eastern Brick Mold N/S
 with Stucco Key



Clear Pine T&G Wainscot

lengths available: 3' thru 16'

(arranged in order of width; items are approximate scale only)



2000SP 3/8 x 3-3/8 **Solid Pine Beaded T&G Wainscot** N
2002SP 9/16 x 5-1/2 **Solid Pine Beaded T&G Wainscot** N/S

2001SP 3/8 x 3-3/8 **Solid Pine Flat T&G Wainscot** N
2003SP 9/16 x 5-1/2 **Solid Pine Flat T&G Wainscot** N/S

Knotty Pine T&G Wainscot

lengths available: 6' thru 16'



2000KP 3/8 x 3-1/4 **Knotty Pine Beaded T&G Wainscot** S

2001KP 3/8 x 3-3/8 **Knotty Pine Flat T&G Wainscot** S

Window Stool

lengths available: 8' thru 16'



990SP 11/16 x 4-1/2 **Solid Pine Ogee Window Stool** N
992SP 11/16 x 5-1/2 **Solid Pine Ogee Window Stool** N



979SP 11/16 x 5-1/2 **Solid Pine Flat Window Stool** S
980SP 11/16 x 4-3/4 **Solid Pine Flat Window Stool** S
985SP 11/16 x 7-1/4 **Solid Pine Flat Window Stool** S



981SP 7/8 x 2-1/2 **Solid Pine Rabbeted Window Stool** S
982SP 7/8 x 3-1/2 **Solid Pine Rabbeted Window Stool** S
984SP 7/8 x 5-1/2 **Solid Pine Rabbeted Window Stool** S

Miscellaneous

(arranged in order of width; items are approximate scale only)

lengths available: 8' thru 16'

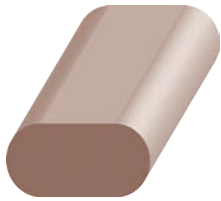

901SP 3/8 x 3/4
Solid Pine Parting Bead **N/S**

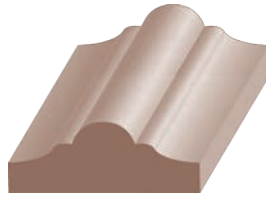

903SP 3/8 x 1
Solid Pine Flat Hoffco **S**

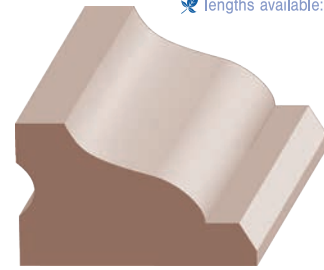

904SP 3/4 x 1-1/4
Solid Pine Drip Mold **S**

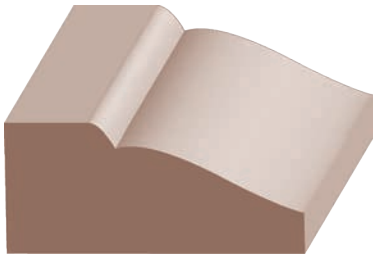

900SP 11/16 x 1-5/8
Solid Pine Band Mold **S**

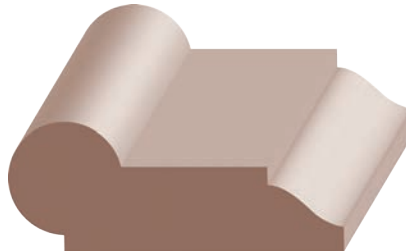

916SP 3/4 x 1-3/4
Solid Pine Picture Mould **N**

905SP 11/16 x 1-5/8
Solid Pine #1139 Picture Mould **S**

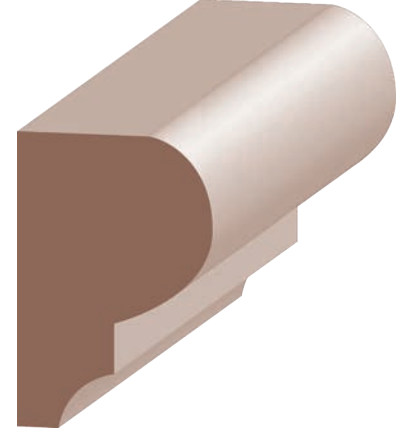

909SP 1 x 1-5/8
Solid Pine Nose & Cove **N/S**

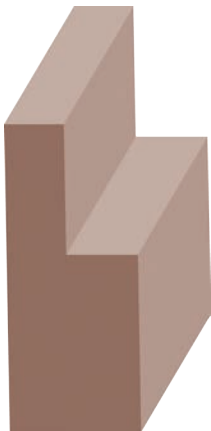

911SP 11/16 x 1-5/8
Solid Pine Rab't Shelf Cleat **N**
[with 3/8" x 11/16" Rab't]

Chamfer

lengths available: 8' thru 16'



906SP 1/2 x 1/2
Solid Pine Chamfer **N/S**



907SP 3/4 x 3/4
Solid Pine Chamfer **N/S**

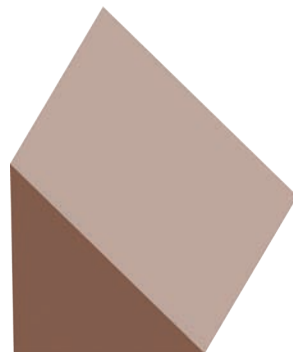

908SP 1 x 1
Solid Pine Chamfer **N/S**

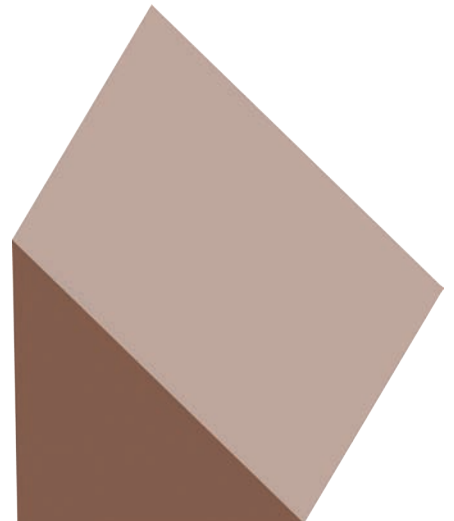

912SP 1-1/2 x 1-1/2
Solid Pine Chamfer **N**

Weatherstrip Kerfed Exterior Door Frames

(arranged in order of width; items are approximate scale only)

1-3/4" doors only



Exterior Door Frame Specs

- ☞ 1-1/4" Thick
- ☞ 6/8 = 82-1/2" Below Dado
- ☞ 8/0 = 98-1/2" Below Dado
- ☞ No Screen Rabbet
- ☞ Single End Dado (Except on Lineal)
- ☞ 3 Pair Per Bundle
- ☞ Kerfing for Bullnose is Available
- ☞ Ripped to Width Available
- ☞ Rab't Measures 1/2" x 2-1/8"

| EXTERIOR DOOR FRAMES Weatherstrip Kerfed | | | |
|---|------------|---------|-----|
| For 1/2" x 2-1/8" Door Rab't. | | | |
| | Solid Pine | | |
| SIZE | 6/8 | 8/0 | |
| 4-1/8 | 418WSP6 | 418WSP8 | N/S |
| 4-5/8 | 458WSP6 | 458WSP8 | N/S |
| 5-1/4 | 514WSP6 | 514WSP8 | N/S |
| 6-5/8 | 658WSP6 | 658WSP8 | N/S |
| 7-1/4 | 714WSP6 | 714WSP8 | N/S |

Standard Frame for 1-3/4" Doors

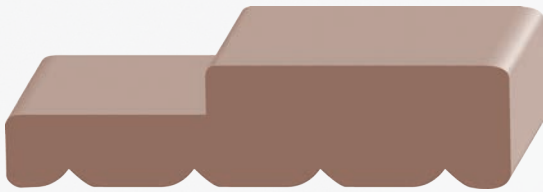

| EXTERIOR DOOR FRAMES Standard | | | |
|----------------------------------|------------|---------|-----|
| For 1/2" x 1-13/16" Door Rab't. | | | |
| | Solid Pine | | |
| SIZE | 6/8 | 8/0 | |
| 4-1/8 | 418SP6 | 418SP8 | N/S |
| 4-5/8 | 458SP6 | 458SP8 | N/S |
| 5-1/4 | 514SPE6 | 514SPE8 | N/S |
| 6-5/8 | 658SP6 | 658SP8 | N/S |
| 7-1/4 | 714SPE6 | 714SPE8 | N/S |

Window Jamb Extension



JAMBEXT 11/16 x 3-15/16 **Jamb Extension N**
(for Andersen® windows)

Interior Door Jambs



Kerfing for bullnose is available on all jamb sizes and species. Custom size odd wall widths available upon request.

Interior Door Jamb Specs

- ☞ 11/16" Thick
- ☞ 6/8 = 81" Below Dado **N**
- ☞ 80-5/8" Below Dado **S**
- ☞ 8/0 = 97" Below Dado **N**
- ☞ 96-5/8" Below Dado **S**
- ☞ Solid Pine jambs may have a glue line where door stop is applied
- ☞ Random Lengths only available in most Solid Wood Species
- ☞ Dado depth is 3/8"
- ☞ Heads cut 3/4 over opening
- ☞ 5 pair per bundle

| INTERIOR DOOR JAMBS | | | | | | | |
|---------------------|------------|----------|-----|---------|----------|----------|---|
| | Solid Pine | | | | Veneer | | |
| SIZE | 6/8 | 8/0 | | SIZE | 6/8 | 8/0 | |
| 4-9/16 | 4916SPI6 | 4916SPI8 | N/S | 4-9/16 | 4916PVI6 | 4916PVI8 | N |
| 4-13/16 | 434SPI6 | 434SPI8 | N | 4-13/16 | 434PVI6 | - | N |
| 5-1/4 | 514SPI6 | 514SPI8 | N/S | 5-1/4 | 514PVI6 | - | N |
| 6-9/16 | - | - | - | 6-9/16 | 6916PVI6 | - | N |
| 7-1/4 | 714SPI6 | 714SPI8 | N/S | 7-1/4 | 714PVI6 | - | N |

Primed & Unprimed Finger-Joint Pine

THE ECONOMICAL CHOICE FOR PAINTED WOOD



Finger-Joint (FJ) Pine consists of small pieces of wood that are recycled and jointed together (repurposed) to create lengths for door casings in 7' or 17' lengths, as well as 16' for crowns, base and chair rails. The advantages to FJ Pine mouldings are the definition of detail, much sharper than MDF, the workability, nailing ease and personal preference for wood. FJ Pine can have some imperfections, grain variances for one, as all natural woods have. Close inspection prior to installation and painting is key. Primed FJ moulding is coated with a water-based gesso. Each piece of moulding is ready for paint once prepping is complete. Please note that 10% of trimbacks (length other than specified) are allowed.

section contents

| | |
|---|-----|
| Base / Base Shoe | 138 |
| Apron..... | 175 |
| Casing..... | 125 |
| Chair Rail..... | 170 |
| Cove | 171 |
| Crown..... | 154 |
| Door Header | 125 |
| Door Stop..... | 137 |
| Exterior Brick & Stucco Mould | 177 |
| Exterior Door Frames..... | 180 |
| Flat Astragal..... | 171 |
| Full Round | 171 |
| Hook & Cleat..... | 176 |
| Interior Door Jambs | 182 |
| Nosing..... | 176 |
| Panel Mold | 172 |
| Panel Mold & Cap..... | 173 |
| Quarter Round | 171 |
| S4S..... | 178 |
| T-Astragal | 171 |
| Wainscot..... | 179 |
| Weatherstrip Kerfed Ext. Door Frames... | 181 |
| Window Stool..... | 175 |

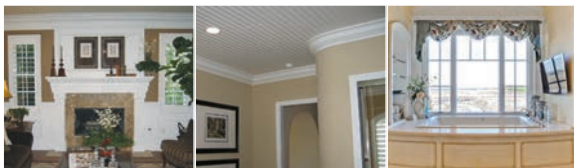

guide

SPECIES

Primed & Unprimed Finger-Joint Pine

INTERIOR/EXTERIOR

I/*E

DESIGN STYLES

TRADITIONAL | CONTEMPORARY | COLONIAL

JANKA
HARDNESS
(POUNDS-FORCE)

710

FINISHING

1

Priming and painting the moulding before it is installed is recommended. Ensure all areas that have filler are dry and sanded before applying any primer or paint.

3

Painting is recommended for moulding surfaces already coated with a primer. In most applications a semigloss coat for durability, washability, and appearance is recommended.

2

If you install the moulding and then finish it, protect the area around the moulding by masking it off with tape. Carefully remove the tape immediately after finishing to prevent its drying to the finish.

4

Please ensure that only higher quality paints with high solids content are used. Two finish coats are recommended for top quality durability and appearance. Water added to paint for dilution can and often causes excess moisture and adversely affects wood.



COMPARED TO SOLID WOOD, FJ MOULDINGS MAKE BETTER USE OF HARVESTED TREES, ARE MORE DIMENSIONALLY STABLE AND LESS LIKELY TO WARP, CUP, OR SPILT. FJ MOULDINGS ARE NOT SUITABLE FOR STAINING BUT GREAT FOR PAINTING.

CUT LIST

Determining How Much You Need

- 1 Measure the room at the height or length where each moulding goes to determine the number and the length of the pieces you'll need.
- 2 FJ primed or unprimed casing and stop is available in 7' on select profiles, 17' on all casing profiles and 16' or 17' on door stop. When figuring how much footage your project requires, for each type of moulding, base, casing, crown, etc., measure your walls or openings and add the footage. Then multiply the footage by 1.1. The result is the total footage needed plus 10% for waste.
- 3 When ordering casing for 6/8 doors: Jambs that are 80-5/8" BD use 7' casing on profiles 3" wide or smaller. Use 17' casing for profiles wider than 3" or for 8/0 doors. Jambs that are 81" BD use 7' casing on profiles 2-1/4" or smaller and 17' casing for profiles wider than 2-1/4" or for 8/0 doors.
- 4 Most door heads are cut from 7' legs (2- 3/0 heads on ONE or BOTH sides of door opening). Always cut the longest pieces first: door legs, window legs, long window heads and sills, and then door heads.
- 5 The most important tool when working with moulding is **patience**. Remember the old adage, measure twice and cut once. Never try to rush trim work.
- 6 Lengths ordered may not always be available. Always verify availability when ordering.

ALWAYS TEST TO MAKE SURE YOUR MEASURING TOOLS ARE ACCURATE. IF YOU ARE WORKING WITH A HELPER, TAKE A MEASUREMENT WITH ONE TOOL WHILE YOUR HELPER MEASURES WITH ANOTHER AND COMPARE YOUR RESULTS.

HELPFUL HINTS

- * Chair rails can be installed 32" to 36" from the floor.
- * Base, shoe, and quarter rounds should be the last mouldings to be installed.
- * Use any brand of spray furniture polish on saw blade as a lubricant for easier cutting.
- * Use Rosettes and Plinth blocks at the corners of windows and doors to eliminate the mitering process.
- * After installation is complete, caulk and/or putty all gaps and nail holes.
- * CHECK the moisture content of all wood moulding: for interior trim, the MC should be 8-10%; for exterior trim the MC should be 12-14%. For every 4% change in MC, wood moves 1%.

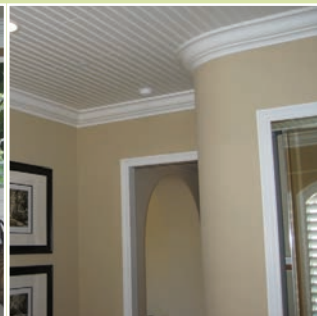

(items are approximate scale only)

1" to 1-5/8" Casing & Door Header

✂ Lengths available: 7' & 17' on profiles up to 2-1/4" wide only – 17' if profile is wider than 2-1/4" [Ⓜ] Mitered pairs available in 7'



PR193FJ 11/16 x 1
Primed FJ Back Band ^N
[Lips 5/8" casing]



PR192FJ 1-1/8 x 1-1/4
Primed FJ Back Band ^N
[Lips 5/8" casing]

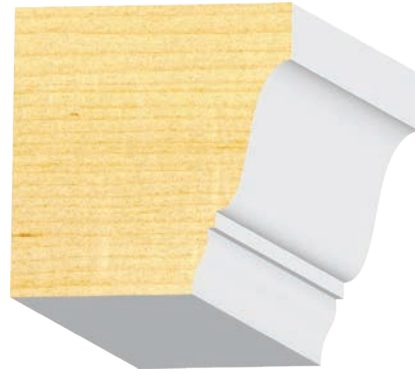

PRHC150FJ 1-5/16 x 2-1/4
Primed FJ Door Header Cap ^{N/S}



PR969FJ 7/16 x 1-1/4
Primed FJ
2 EE Door Header Fillet ^{N/S}



151FJ 9/16 x 1-1/2
Unprimed FJ Pre-fit Casing ^S



PR100FJ 9/16 x 1-5/8
Primed FJ 2 Round Edge Casing ^{N/S}



PR970FJ 11/16 x 1-1/4
Primed FJ
2 EE Door Header Fillet ^{N/S}



101FJ 1/2 x 1-5/8
Unprimed FJ
Streamline Casing ^S

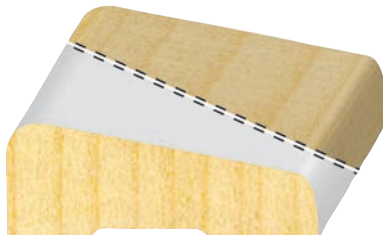

PR102FJ 5/8 x 1-5/8
Primed FJ Beveled/
Streamline Casing [Ⓜ] ^{N/S}



PR107FJ 5/8 x 1-5/8
Primed FJ #711 Casing [Ⓜ] ^S



102FJ 5/8 x 1-5/8
Unprimed FJ Beveled/
Streamline Casing [Ⓜ] ^{N/S}

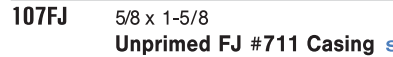

107FJ 5/8 x 1-5/8
Unprimed FJ #711 Casing ^S



PR130FJ 5/8 x 1-5/8
Primed FJ Moulded Casing ^N



PR142FJ 9/16 x 1-5/8
Primed FJ Oval Casing ^N



PR152FJ-1 5/8 x 1-5/8
Primed FJ Colonial 356 Casing ^N

2 to 2-1/4" Casing

(items are approximate scale only)

✂ Lengths available: 7' & 17' on profiles up to 2-1/4" wide only –
 17' if profile is wider than 2-1/4" (M) Mitered pairs available in 7'



121FJ 11/16 x 2
Unprimed FJ Clamshell Casing S



153FJ 9/16 x 2
Unprimed FJ #356 Casing S



PR103BFJ 5/8 x 2-1/4
Primed FJ Beveled/Streamline Casing (M) N/S

103BFJ 5/8 x 2-1/4
Unprimed FJ Beveled Casing (M) N

103FJ 11/16 x 2-1/2
Unprimed FJ Streamline Casing (M) S



PR110BFJ-2 5/8 x 2-1/4 **Primed FJ 3-Step Casing** N/S

110FJ 5/8 x 2-1/2 **Unprimed FJ 3-Step Casing** S



PR120FJ 9/16 x 2-1/4 **Primed FJ 2 Round Edge Casing** N/S

120FJ 9/16 x 2-1/4 **Unprimed FJ 2 Round Edge Casing** N

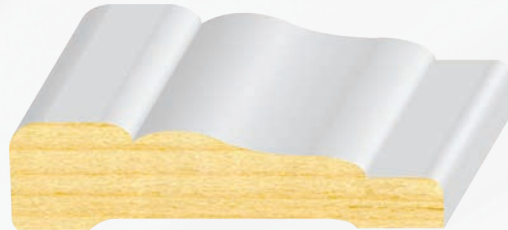

PR141FJ 5/8 x 2-1/4 **Primed FJ Moulded Casing** N



PR143FJ 9/16 x 2-1/4 **Primed FJ Oval Casing** N



PR149FJ-2 5/8 x 2-1/4 **Primed FJ Meridian Casing** N/S

(items are approximate scale only)

2-1/4" to 2-1/2" Casing

✦ Lengths available: 7' & 17' on profiles up to 2-1/4" wide only – 17' if profile is wider than 2-1/4" **M** Mitered pairs available in 7'

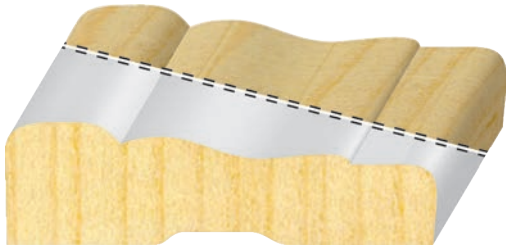

PR152FJ 11/16 x 2-1/4 **Primed FJ Colonial/#356 Casing** **M** N/S
152FJ 11/16 x 2-1/4 **Unprimed FJ Colonial/#356 Casing** **M** N/S

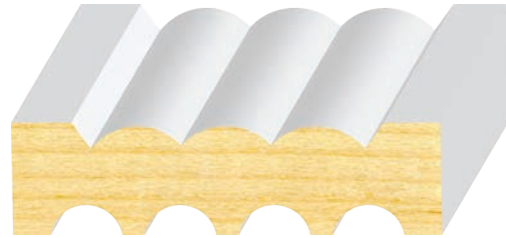

PR158FJ-2 11/16 x 2-1/4
Primed FJ Reversible 4-Flute & Reed Casing **N**



PR162FJ 5/8 x 2-1/4 **Primed FJ Anderson Casing** **N**
162FJ 5/8 x 2-1/4 **Unprimed FJ #366 Casing** **S**
162BFJ 11/16 x 2-1/2 **Unprimed FJ #366 Casing** **S**



PR128FJ 5/8 x 2-7/16 **Primed FJ Mission/Bel-Air Casing** **N/S**
128FJ 5/8 x 2-7/16 **Unprimed FJ Bel-Air Casing** **S**

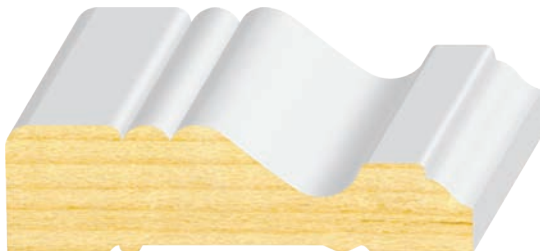

PR132FJ 11/16 x 2-7/16 **Primed FJ Carolina/Palisade Casing** **N/S**



PR137FJ 11/16 x 2-7/16 **Primed FJ Carmel Casing** **N/S**



PR167FJ 11/16 x 2-7/16 **Primed FJ Santa Fe/#275 Casing** **N/S**
167FJ 11/16 x 2-7/16 **Unprimed FJ #275 Casing** **S**



PR108FJ 5/8 x 2-1/2 **Primed FJ #711 Casing** **S**
108FJ 5/8 x 2-1/2 **Unprimed FJ #711 Casing** **S**

2-1/2" Casing

(items are approximate scale only)

✂ Lengths available: 7' & 17' on profiles up to 2-1/4" wide only –
17' if profile is wider than 2-1/4" **M** Mitered pairs available in 7'



115FJ 5/8 x 2-1/2 **Unprimed FJ Universal Casing** **S**

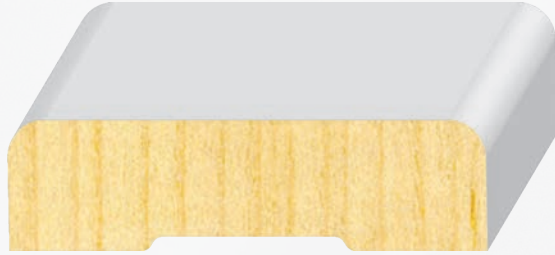

PR120BFJ 11/16 x 2-1/2 **Primed FJ 2RE Casing** **N/S**



PR131FJ 11/16 x 2-1/2 **Primed FJ Riviera Casing** **M N/S**

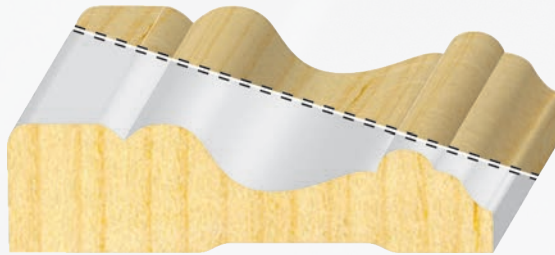

PR150FJ 5/8 x 2-1/2 **Primed FJ Cape Cod Casing** **N/S**
150FJ 5/8 x 2-1/2 **Unprimed FJ Cape Cod Casing** **S**



PR157FJ 1-1/4 x 2-1/2 **Primed FJ Coronado Casing** **S**
157FJ 1-1/4 x 2-1/2 **Unprimed FJ Coronado Casing** **S**



PR159FJ 1 x 2-1/2 **Primed FJ Hermosa Casing** **S**
159FJ 1 x 2-1/2 **Unprimed FJ Hermosa Casing** **S**



PR163FJ 5/8 x 2-1/2 **Primed FJ Monterey Casing** **S**
163FJ 5/8 x 2-1/2 **Unprimed FJ Monterey Casing** **S**



164FJ 1-1/4 x 2-1/2 **Unprimed FJ Bell Court Casing** **S**

(items are approximate scale only)

2-1/2" to 3" Casing

✂ Lengths available: 7' & 17' on profiles up to 2-1/4" wide only – 17' if profile is wider than 2-1/4"  Mitered pairs available in 7'



PR169FJ 11/16 x 2-1/2 **Primed FJ Victorian/Tudor Casing** N/S
169FJ 11/16 x 2-1/2 **Unprimed FJ Tudor Casing** S

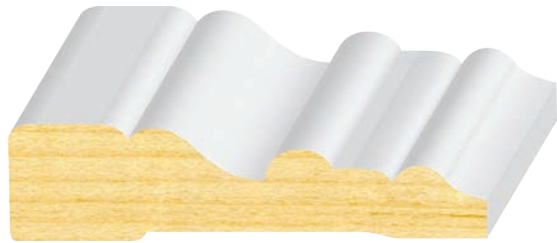

PR175FJ-2 5/8 x 2-1/2 **Primed FJ Sierra Casing** N/S

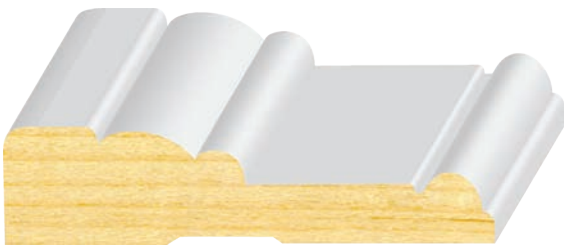

PR123FJ 5/8 x 2-9/16 **Primed FJ Montecito Casing** S



PR172FJ-2 11/16 x 2-1/2 **Primed FJ Contemporary Casing** N/S



PR119FJ 11/16 x 2-7/8 **Primed FJ Solano/Colonial Casing** N/S
119FJ 11/16 x 2-7/8 **Unprimed FJ Colonial Casing** S



PR146FJ-2 11/16 x 2-1/4 **Primed FJ Classic Beaded Casing** N/S



147FJ 1-3/16 x 2-7/8 **Unprimed FJ Palos Verdes Casing** S



PR165FJ 5/8 x 3 **Primed FJ #275 Casing** S
165FJ 5/8 x 3 **Unprimed FJ #275 Casing** S

3-3/16" to 3-1/4" Casing

(items are approximate scale only)

✦ Lengths available: 7' & 17' on profiles up to 2-1/4" wide only – 17' if profile is wider than 2-1/4"  Mitered pairs available in 7'



PR148FJ 13/16 x 3-3/16 **Primed FJ Piedmont Casing** **N**



PR110FJ-3 5/8 x 3-1/4 **Primed FJ 3-Step Casing** **N/S**



126FJ 11/16 x 3-1/4 **Unprimed FJ Crescent Casing** **S**



PR129FJ 5/8 x 3-1/4 **Primed FJ Mission/Bel-Air Casing** **N/S**



PR133FJ 11/16 x 3-1/4 **Primed FJ Carolina Casing** **N**

PR133BFJ 11/16 x 3-9/16 **Primed FJ Palisade Casing** **S**

(items are approximate scale only)

3-1/4" Casing

✂ Lengths available: 7' & 17' on profiles up to 2-1/4" wide only – 17' if profile is wider than 2-1/4"  Mitered pairs available in 7'



PR135FJ 11/16 x 3-1/4 **Primed FJ Monterey/Colorado Casing** N/S



PR139FJ 9/16 x 3-1/4 **Primed FJ 2 Round Edge Casing** N/S



154FJ-3 1/2 x 3-1/4 **Unprimed FJ 3-Flute Casing (Not Reversible)** S

✂ lengths available: 14' & 16' + Trimbacks

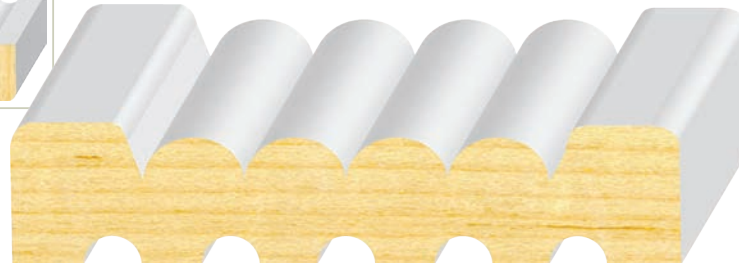

PR158FJ-3 11/16 x 3-1/4 **Primed FJ Reversible 5-Flute & Reed Casing** N



160FJ 1-1/4 x 3-1/4 **Unprimed FJ Hermosa Casing** S



3-1/4" Casing

(items are approximate scale only)

✂ Lengths available: 7' & 17' on profiles up to 2-1/4" wide only –
 17' if profile is wider than 2-1/4"  Mitered pairs available in 7'



161FJ 5/8 x 3-1/4 **Unprimed FJ Cambridge Casing** S
 ✂ lengths available: 17' + Trimbacks



162FJ-3 11/16 x 3-1/4 **Unprimed FJ #366 Casing** S



PR170FJ 1 x 3-1/4 **Primed FJ Tudor Casing** S

170FJ 1 x 3-1/4 **Unprimed FJ Tudor Casing** S

✂ lengths available: 17' + Trimbacks



PR176FJ 5/8 x 3-1/4 **Primed FJ Moulded Casing** N/S

176FJ 5/8 x 3-1/4 **Unprimed FJ Moulded Casing** N



PR177FJ 1-1/16 x 3-1/4 **Primed FJ Howe Casing** N

PR177BFJ 11/16 x 3 **Primed FJ Howe Casing** S

(items are approximate scale only)

3-1/4" to 3-7/16" Casing

✂ Lengths available: 7' & 17' on profiles up to 2-1/4" wide only – 17' if profile is wider than 2-1/4"  Mitered pairs available in 7'

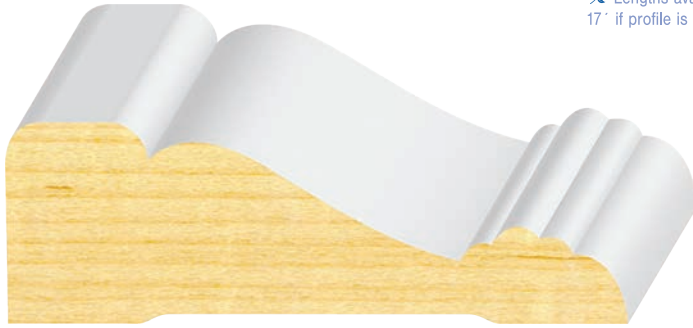

PR186FJ 1 x 3-1/4 **Primed FJ 49er Casing** N



PR166FJ 1-1/16 x 3-3/8 **Primed FJ Santa Fe/#275 Casing** N/S

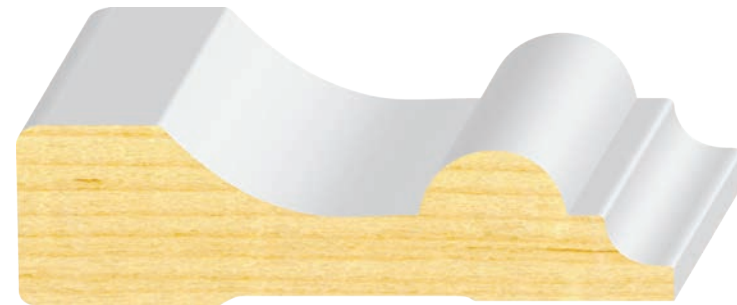

PR146FJ-3 7/8 x 3-7/16 **Primed FJ Classic Beaded Casing** N/S



PR149FJ-3 7/8 x 3-7/16 **Primed FJ Meridian Casing** N/S

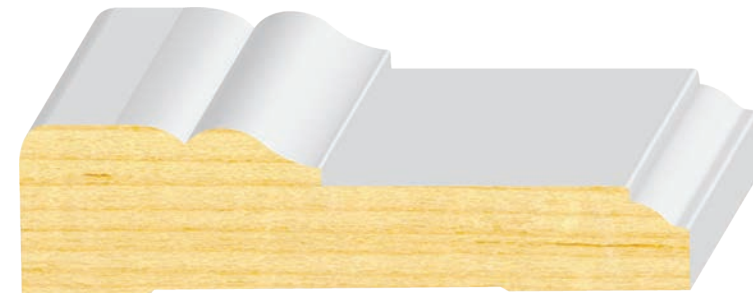

PR156FJ 5/8 x 3-7/16 **Primed FJ Shasta Casing** N

3-7/16" to 3-1/2" Casing

(items are approximate scale only)

✂ Lengths available: 7' & 17' on profiles up to 2-1/4" wide only –
 17' if profile is wider than 2-1/4" **M** Mitered pairs available in 7'

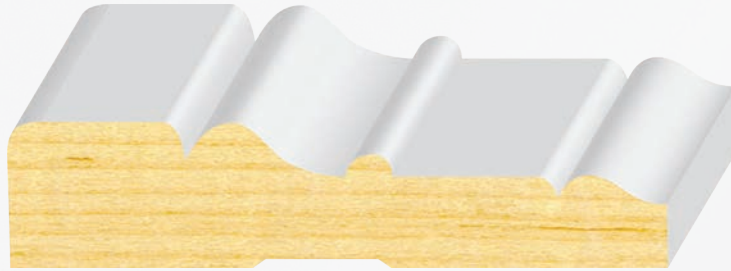

PR175FJ-3 11/16 x 3-7/16 **Primed FJ Sierra Casing** *N/S*



117FJ 9/16 x 3-1/2 **Unprimed FJ Colonial Base/Casing** *S*



138FJ 1 x 3-1/2 **Unprimed FJ Crescent Casing** *S*
 [FORMERLY 166A]

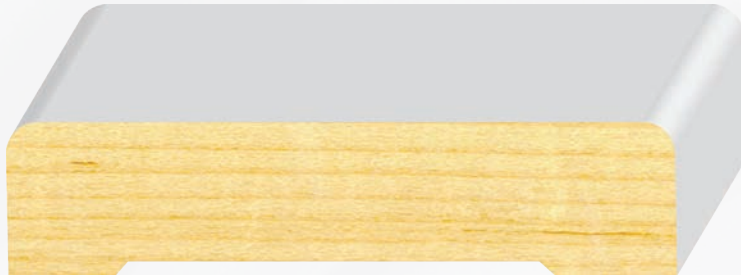

PR139BFJ 13/16 x 3-1/2 **Primed FJ 2 Round Edge Casing** *N/S*



155FJ 11/16 x 3-1/2 **Unprimed FJ Cape Cod Casing** *S*

(items are approximate scale only)

3-1/2" to 4" Casing

✂ Lengths available: 7' & 17' on profiles up to 2-1/4" wide only – 17' if profile is wider than 2-1/4" **M** Mitered pairs available in 7'



156FJ 11/16 x 3-1/2 **Unprimed FJ Chesapeake Casing** **S**



158FJ-3 1/2 x 3-1/2 **Unprimed FJ 5-Flute Casing (Not Reversible)** **S**

✂ lengths available: 16' + Trimbacks



PR172FJ-3 11/16 x 3-1/2 **Primed FJ Contemporary Casing** **N/S**



PR198FJ 11/16 x 3-1/2 **Primed FJ Valley Casing** **N**



PR199FJ 11/16 x 4 **Primed FJ 2 Eased Edge Craftsman Casing** **N/S**
[FORMERLY PR186A]

4-1/4" to 5-1/2" Casing

(items are approximate scale only)

✦ Lengths available: 7' & 17' on profiles up to 2-1/4" wide only –
 17' if profile is wider than 2-1/4" **M** Mitered pairs available in 7'



PR118FJ-4 9/16 x 4-1/4 **Primed FJ Colonial Base/Casing** **S**
PR362FJ-4 9/16 x 4-1/4 **Primed FJ Solano Base/Casing** **N**
118FJ-4 9/16 x 4-1/4 **Unprimed FJ Colonial Base/Casing** **S**



PR146FJ-4 7/8 x 4-1/4 **Primed FJ Classic Beaded Casing** **N/S**



PR136FJ 13/16 x 4-1/4 **Primed FJ Monterey/Colorado Casing** **N/S**

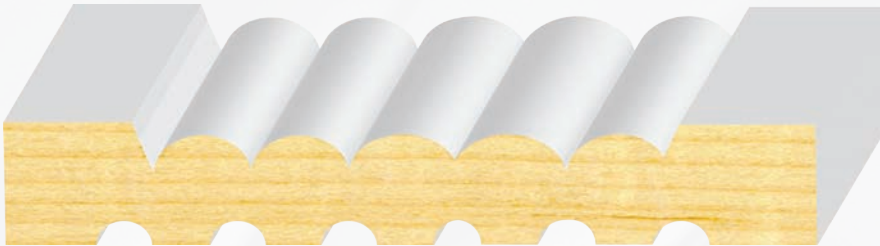

PR158FJ-4 11/16 x 4-1/4 **Primed FJ Reversible 6-Flute & Reed Casing** **N**



173FJ 1/2 x 5-1/2 **Unprimed FJ 4-Flute Casing** **S**
 ✦ lengths available: 16' + Trimbacks



Door Stop

lengths available: 7' & 17'

(items are approximate scale only)

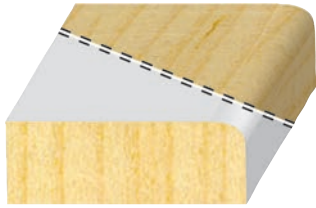

PR201FJ 7/16 x 1-1/4
Primed FJ
1 Round Edge Stop N/S

201FJ 7/16 x 1-1/4
Unprimed FJ
1 Round Edge Stop N/S

202BFJ 3/8 x 1-1/4
Unprimed FJ
1 Round Edge Stop N

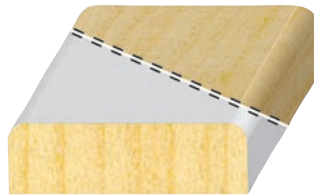

PR202FJ 3/8 x 1-1/4
Primed FJ 2RE Stop S

202FJ 3/8 x 1-1/4
Unprimed FJ 2RE Stop S



206FJ 1/2 x 1-1/4
Unprimed FJ 1RE Stop S



PR208FJ 7/16 x 1-1/4
Primed FJ Ogee Stop N



PR210FJ 1/2 x 1-3/4
Primed FJ
Ogee Stop S

210FJ 1/2 x 1-3/4
Unprimed FJ
Ogee Stop S



PR210BFJ 7/16 x 1-3/8
Primed FJ
Colonial Stop N

210BFJ 7/16 x 1-3/8
Unprimed FJ
Colonial Stop N

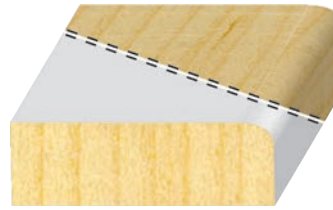

PR216FJ 7/16 x 1-3/8
Primed FJ 1RE Stop N

216FJ 7/16 x 1-3/8
Unprimed FJ 1RE Stop N



PR219FJ 7/16 x 1-3/8
Primed FJ Ogee Stop N



PR209FJ 1/2 x 1-1/2
Primed FJ 1RE Stop N/S

209FJ 1/2 x 1-1/2
Unprimed FJ 1RE Stop S



211FJ 1/2 x 1-1/2
Unprimed FJ Kerfed 1
Round Edge Stop w/Vinyl S
 lengths available: 7'



9023 7/16 x 1-3/8
Gray 3-Finger Vinyl
for Kerfed Stop S



PR213FJ 11/16 x 1-11/16
Primed FJ Howe Stop N
 lengths available: 7' & 17' only



212KFJ 1/2 x 2
Unprimed FJ Stop w/Kerf S

209KFJ 1/2 x 1-1/2
Unprimed FJ Stop w/Kerf S



220FJ 9/16 x 2-1/4
Unprimed FJ Garage Door Stop N
 lengths available: 16' only



3/4" to 2-1/4" Base & Base Shoe

lengths available: 16' + trimbacks – Flexible moulding available for all profiles

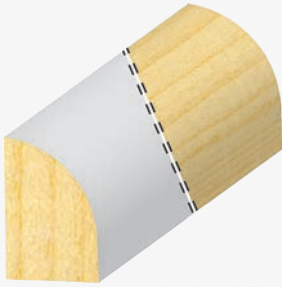

PR300AFJ 3/8 x 3/4
Primed FJ Base Shoe N/S
PR300ALVL **Primed FJ LVL Base Shoe** N/S
300AFJ 3/8 x 3/4 **Unprimed FJ Base Shoe** S

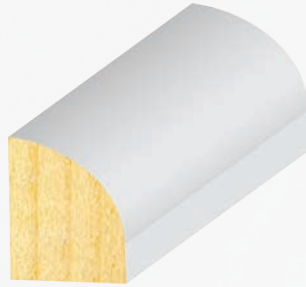

PR300BFJ 1/2 x 3/4
Primed FJ Base Shoe N/S
PR300BLVL **Primed LVL Base Shoe** N/S



301FJ 7/16 x 1-1/2
Unprimed FJ Flat Base/Apron N/S

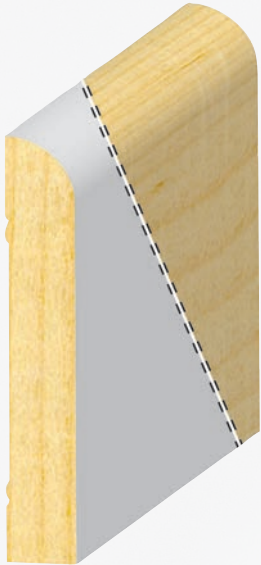

PR304FJ 3/8 x 2-1/4
Primed FJ Streamline Base S
304FJ 3/8 x 2-1/4
Unprimed FJ Streamline Base S



PRR304FJ-2 3/8 x 2-1/4
Primed FJ Reversible Base N
PRR305FJ-2 1/2 x 2-1/4
Primed FJ Reversible Base N



PR306FJ 1/2 x 2-1/4
Primed FJ Streamline Base N



PR314FJ-2 7/16 x 2-1/4
Primed FJ Coronado Base N

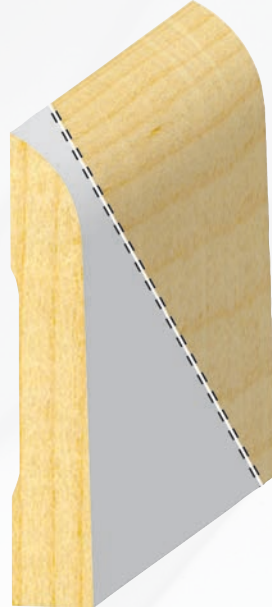

PR305FJ 7/16 x 2-1/2
Primed FJ Streamline Base S
305FJ 7/16 x 2-1/2
Unprimed FJ Streamline Base S

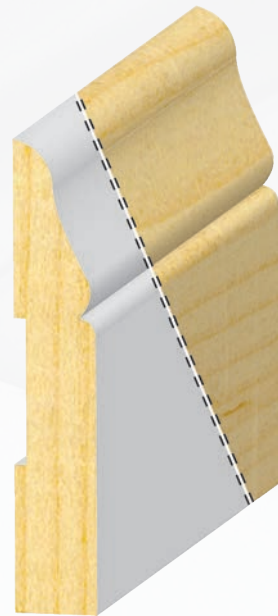

PR310FJ 7/16 x 2-1/2
Primed FJ #711 Base S
310FJ 7/16 x 2-1/2
Unprimed FJ #711 Base S
310BFJ 5/8 x 2-1/2
Unprimed FJ #711 Base S

(items are approximate scale only)

2-1/2" to 3-1/4" Base

✂ lengths available: 16' + trimbacks – Flexible moulding available for all profiles



321FJ-2 7/16 x 2-1/2
Unprimed FJ 3-Step Base S
 [FORMERLY 312A]



319FJ 1/2 x 2-1/2
Unprimed FJ #356 Base S



PRR304FJ-3 3/8 x 3-1/4
Primed FJ Reversible Base N

PRR305FJ-3 1/2 x 3-1/4
Primed FJ Reversible Base N

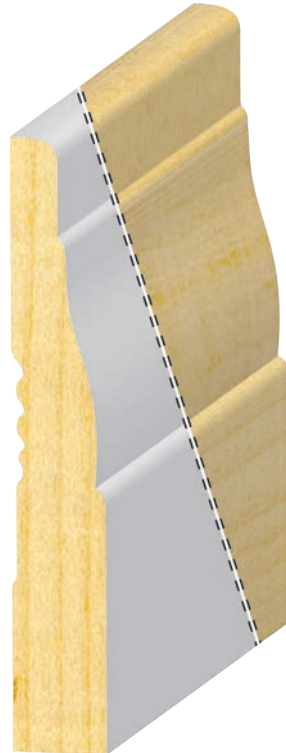

PR320FJ 7/16 x 3-1/4
Primed FJ Colonial 356 Base N/S

320FJ 7/16 x 3-1/4
Unprimed FJ #356 Base S

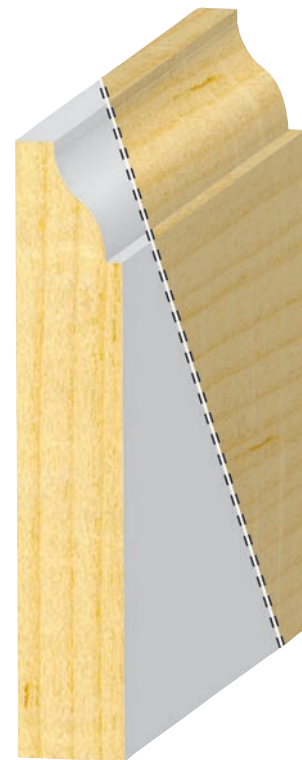

PR314FJ-3 9/16 x 3-1/4
Primed FJ Coronado/#623 Base N/S

314FJ-3 9/16 x 3-1/4
Unprimed FJ Coronado/#623 Base N/S

314FJ-3SC 1/2 x 3-3/16
Unprimed FJ Scant #623 Base S



3-1/4" to 3-7/16" Base

(items are approximate scale only)

✦ lengths available: 16' + trimbacks – Flexible moulding available for all profiles



PR344FJ-3 9/16 x 3-1/4
Primed FJ Peninsula Base N



PR347FJ-3 9/16 x 3-1/4
Primed FJ Edgewood Base N

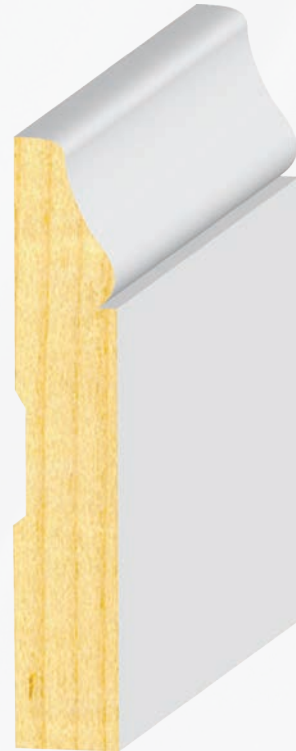

PR356FJ-3 9/16 x 3-1/4
Primed FJ Riviera Base N



PR371FJ-3 9/16 x 3-1/4
Primed FJ Montecito Base N



PR338FJ-3 9/16 x 3-7/16
Primed FJ Santa Fe/#175 Base N/S



339FJ 9/16 x 3-7/16
Unprimed FJ Crescent Base S

(items are approximate scale only)

3-7/16" to 3-1/2" Base

✦ lengths available: 16' + trimbacks – Flexible moulding available for all profiles



PR358FJ 9/16 x 3-7/16
Primed FJ Classic Beaded Base **N/S**



PR365FJ-3 9/16 x 3-7/16
Primed FJ Crescent/Lancaster Base **N/S**



117FJ 9/16 x 3-1/2
Unprimed FJ Colonial Base/Casing **S**



PR118FJ-3 9/16 x 3-1/2
Primed FJ Colonial Base **S**

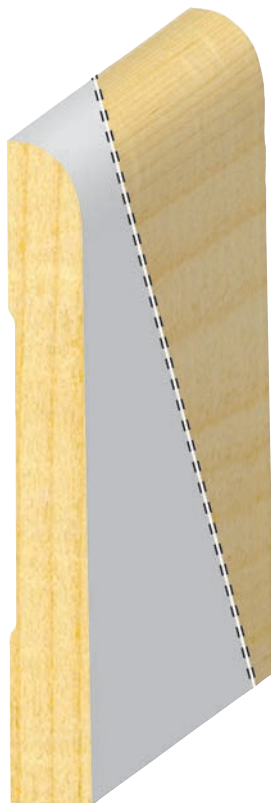

PR307FJ 7/16 x 3-1/2
Primed FJ Streamline Base **S**

307FJ 7/16 x 3-1/2
Unprimed FJ Streamline Base **S**

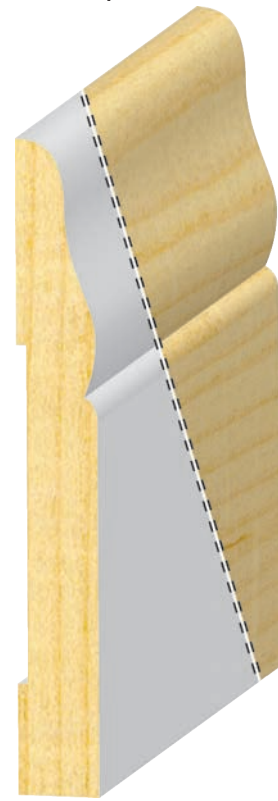

PR311FJ 7/16 x 3-1/2
Primed FJ #711 Base **S**

311FJ 7/16 x 3-1/2
Unprimed FJ #711 Base **S**



3-1/2" to 3-3/4" Base

(items are approximate scale only)

✦ lengths available: 16' + trimbacks – Flexible moulding available for all profiles



321FJ-3 1/2 x 3-1/2
Unprimed FJ
3 Step Base **S**



367FJ 1 x 3-1/2
Unprimed FJ
Palos Verdes Base **S**
 [FORMERLY 327FJ]



PR387FJ-3 7/16 x 3-1/2
Primed FJ 1 Eased
Edge Craftsman Base **N/S**



324FJ 9/16 x 3-3/4
Unprimed FJ
Hermosa Base **S**



(items are approximate scale only)

4-1/4" Base

✂ lengths available: 16' + trimbacks – Flexible moulding available for all profiles

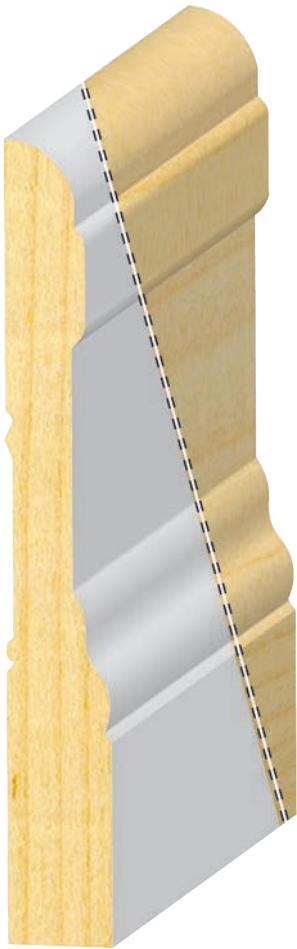

PR362FJ-4 9/16 x 4-1/4
Primed FJ
Solano Base N



PR314FJ-4 9/16 x 4-1/4
Primed FJ
Coronado/#620 Base N/S

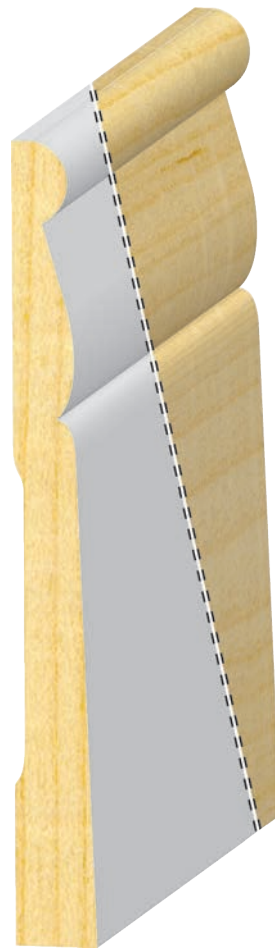

PR316FJ 7/16 x 4-1/4
Primed FJ
Monterey Base S

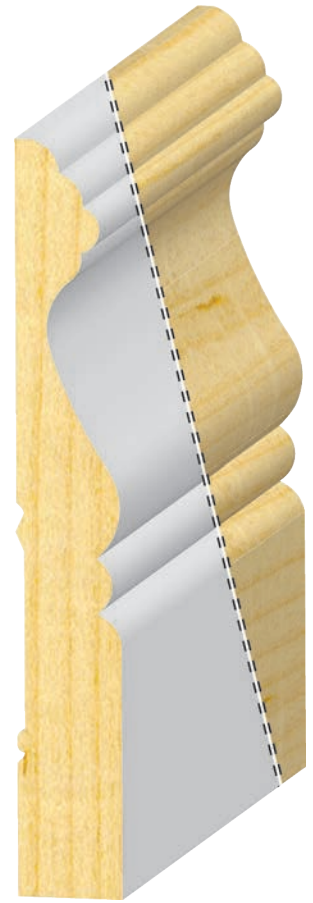

PR318BFJ-4 9/16 x 4-1/4
Primed FJ
Cape Cod Base N/S

PR118FJ-4 9/16 x 4-1/4
Primed FJ
Colonial Base S

316FJ 7/16 x 4-1/4
Unprimed FJ
Monterey Base S

318FJ-4 9/16 x 4
Unprimed FJ
Cape Cod Base S

118FJ-4 9/16 x 4-1/4
Unprimed FJ
Colonial Base S

base | primed & unprimed fj pine



4-1/4" Base

✦ lengths available: 16' + trimbacks – Flexible moulding available for all profiles

(items are approximate scale only)

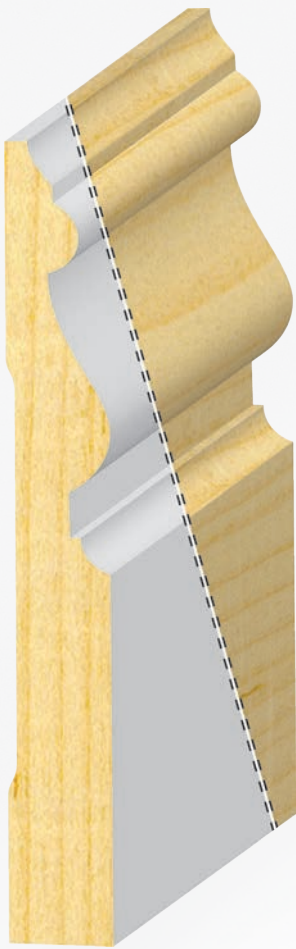

PR325FJ 9/16 x 4-1/4
Primed FJ
Imperial/#175 Base N/S

325FJ 9/16 x 4-1/4
Unprimed FJ
#175 Base S



326FJ 11/16 x 4-1/4
Unprimed FJ
Crescent Base S



PR371FJ-4 9/16 x 4-1/4
Primed FJ
Montecito Base N

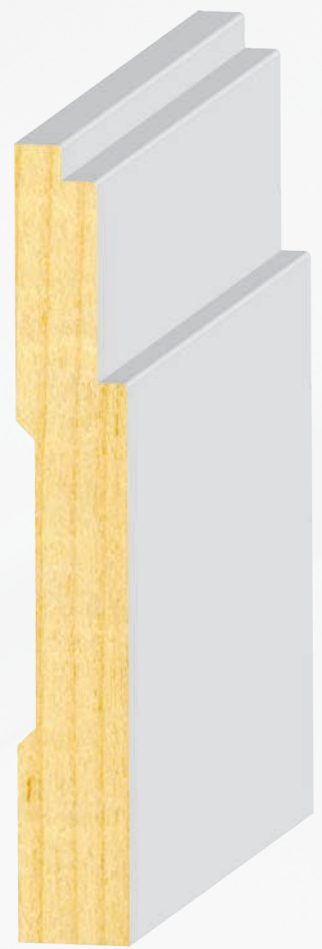

PR349FJ-4 9/16 x 4-1/4
Primed FJ
Meridian Base N/S

primed & unprimed fj pine | base



(items are approximate scale only)

4-1/2" Base

lengths available: 16' + trimbacks — Flexible moulding available for all profiles

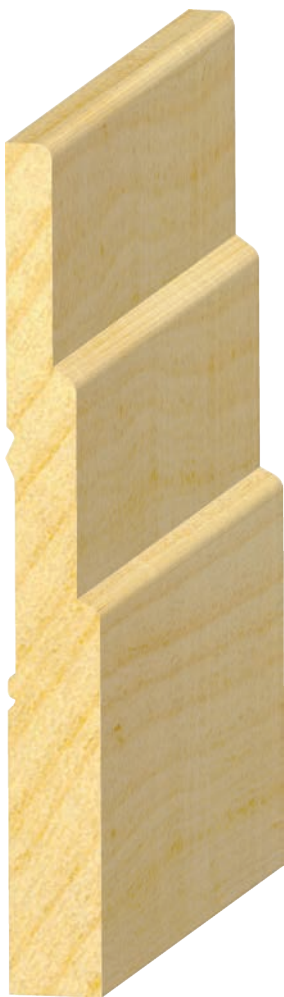

321FJ-4 1/2 x 4-1/2
Unprimed FJ
3-Step Base **S**



PR338FJ-4 9/16 x 4-1/2
Primed FJ
Santa Fe/#175 Base **N/S**



PR380FJ 9/16 x 4-1/2
Primed FJ Carolina/
Palisade Base **N/S**

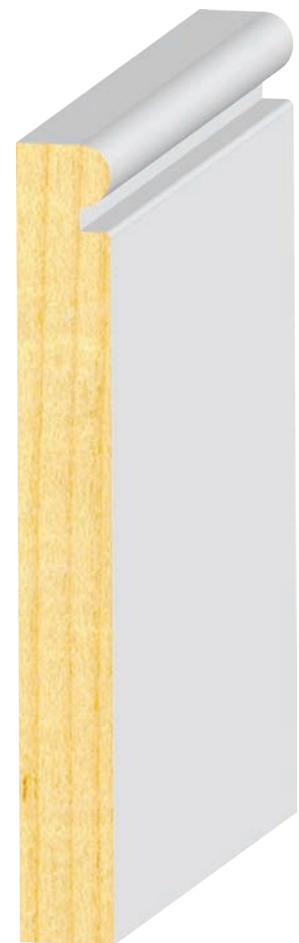

PR372FJ-4 9/16 x 4-1/4
Primed FJ
Contemporary Base **N/S**



5" to 5-1/4" Base

(items are approximate scale only)

✦ lengths available: 16' + trimbacks – Flexible moulding available for all profiles

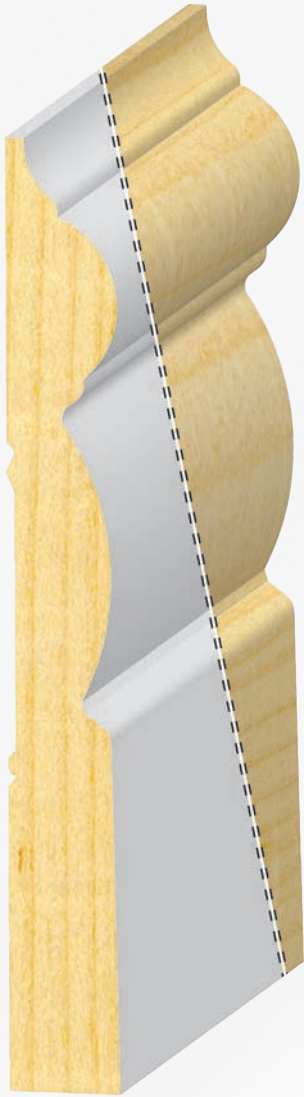

PR323FJ 9/16 x 5
Primed FJ
Mission/Hermosa Base N/S

323FJ 9/16 x 5
Unprimed FJ
Hermosa Base S

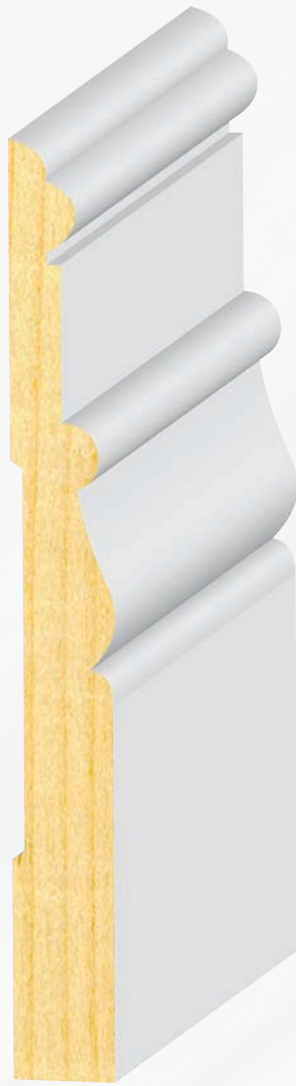

PR336FJ 9/16 x 5
Primed FJ Sierra/
Montecito Base N/S



PR347FJ-5 9/16 x 5-3/16
Primed FJ
Edgewood Base N

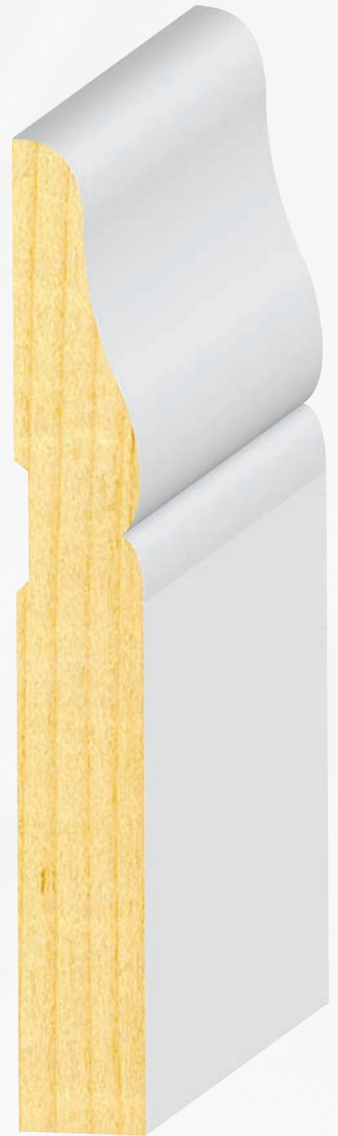

PR313FJ 11/16 x 5-1/4
Primed FJ
Classic Base N



(items are approximate scale only)

5-1/4" Base

✂ lengths available: 16' + trimbacks – Flexible moulding available for all profiles

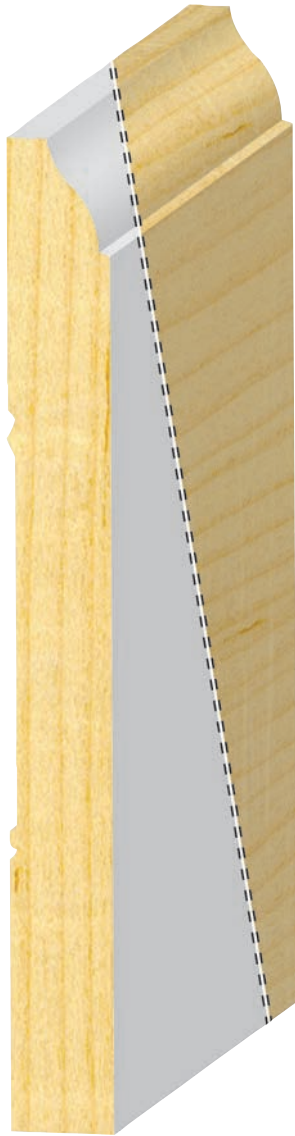

PR314FJ-5 9/16 x 5-1/4
Primed FJ
Coronado/#618 Base N/S

314FJ-5 9/16 x 5-1/4
Unprimed FJ #618 Base S



317FJ 9/16 x 5-1/4
Unprimed FJ
Crescent Base S

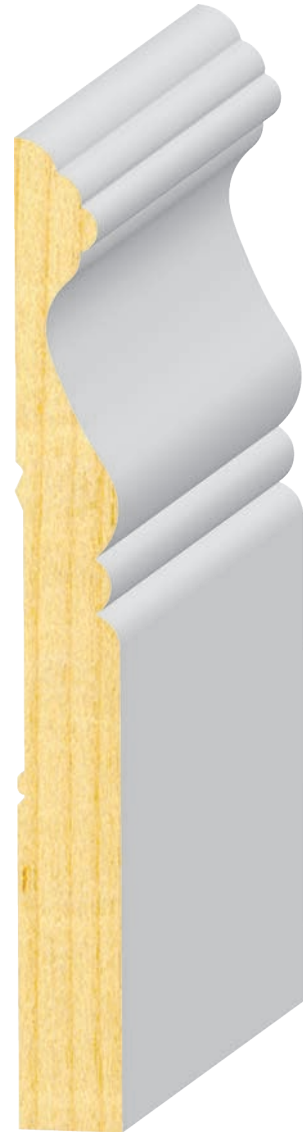

PR318FJ-5 9/16 x 5-1/4
Primed FJ
Cape Cod Base N/S



5-1/4" Base

(items are approximate scale only)

✦ lengths available: 16' + trimbacks – Flexible moulding available for all profiles



318BFJ 9/16 x 5-1/4
Unprimed FJ
"B" Cape Cod Base *S*

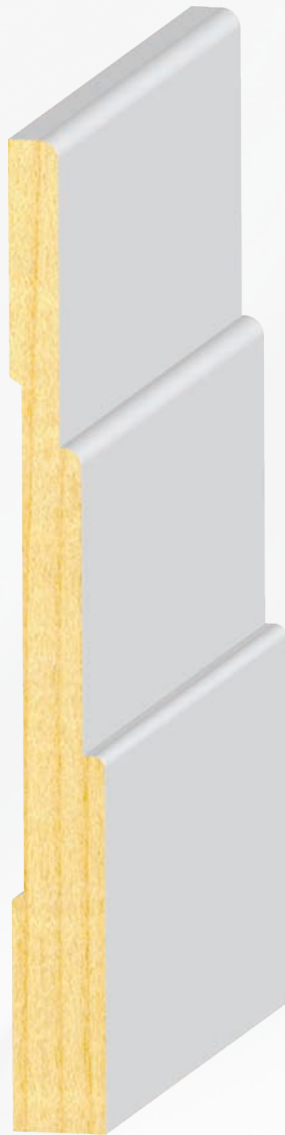

PR321FJ-5 1/2 x 5-1/4
Primed FJ
3-Step Base *N/S*

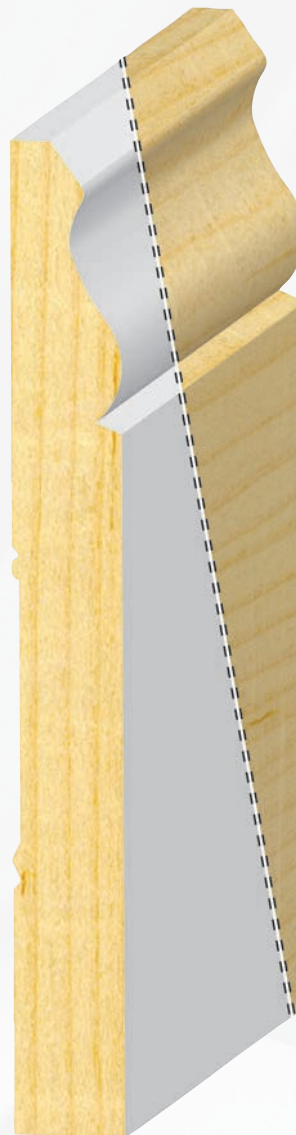

328FJ-5 9/16 x 5-1/4
Unprimed FJ
Colonial Base *S*

PR328FJ-5 9/16 x 5-1/4
Primed FJ
Vintage/Colonial
Base *N/S*

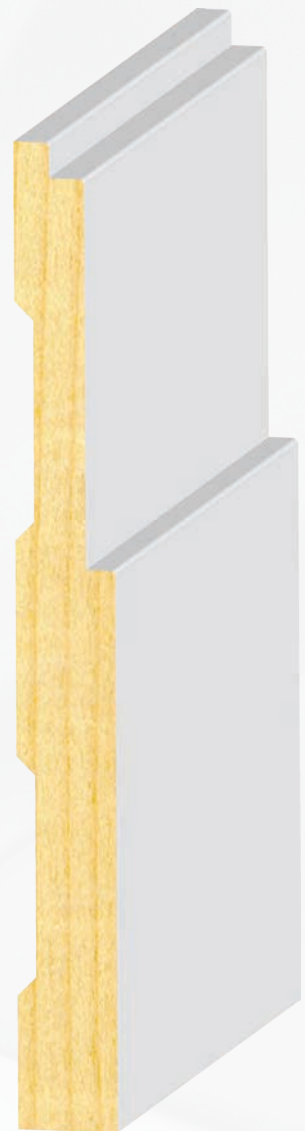

PR349FJ-5 9/16 x 5-1/4
Primed FJ
Meridian Base *N/S*

primed & unprimed fj pine | base



(items are approximate scale only)

5-1/4" Base

✂ lengths available: 16' + trimbacks – Flexible moulding available for all profiles

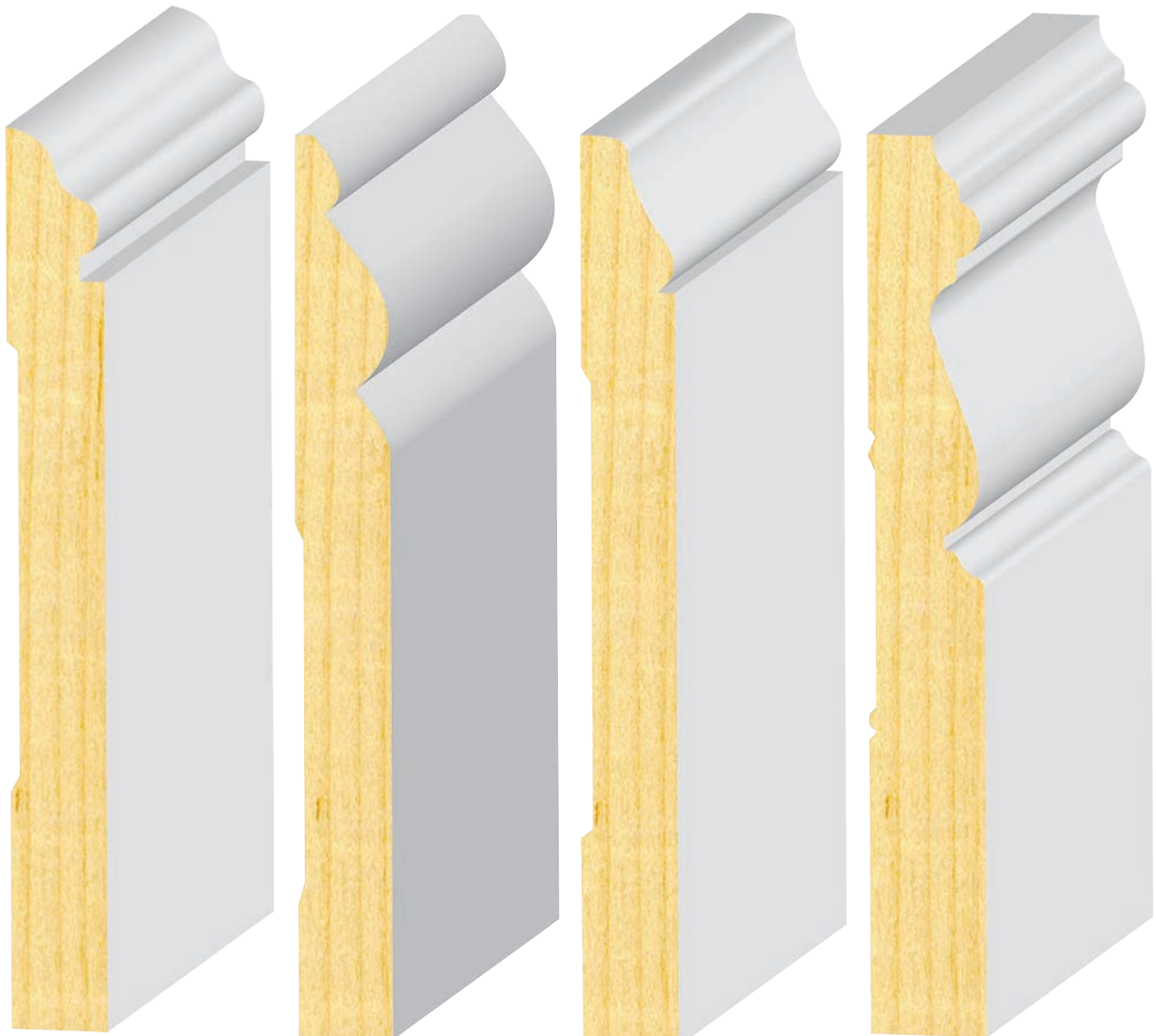

PR344FJ-5 9/16 x 5-1/4
Primed FJ
Peninsula Base **N**

PR352FJ 9/16 x 5-1/4
Primed FJ
Sierra Base **N**

PR356FJ-5 9/16 x 5-1/4
Primed FJ
Riviera Base **N**

PR361FJ-5 11/16 x 5-1/4
Primed FJ
Monterey/Sonoma Base **N/S**



5-1/4" Base

lengths available: 16' + trimbacks – Flexible moulding available for all profiles

(items are approximate scale only)

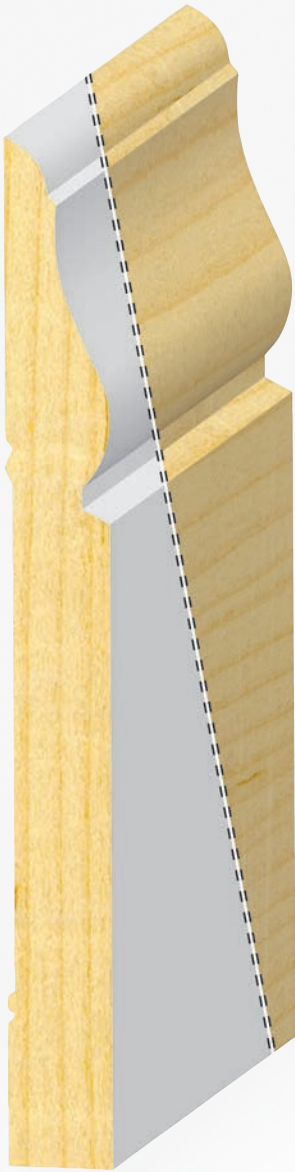

PR365FJ-5 5/8 x 5-1/4
Primed FJ
Crescent/Lancaster Base N/S

365FJ 5/8 x 5-1/4
Unprimed FJ Lancaster Base s



PR371FJ-5 9/16 x 5-1/4
Primed FJ
Montecito Base N



PR372FJ-5 9/16 x 5-1/4
Primed FJ
Contemporary Base N/S



(items are approximate scale only)

5-7/16" Base

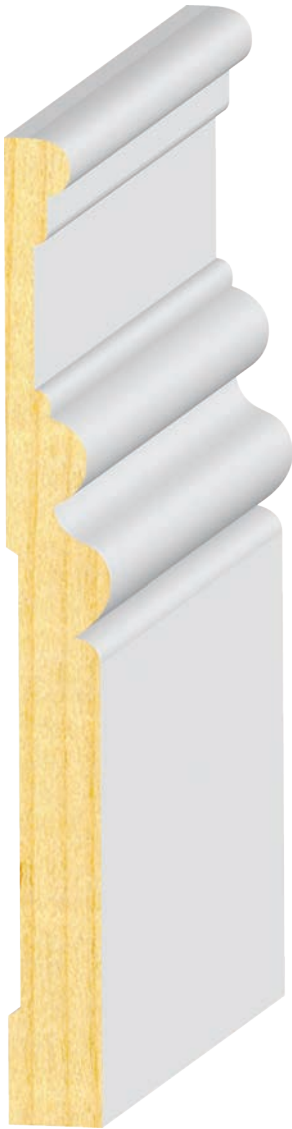

PR384FJ 9/16 x 5-1/4
Primed FJ Howe Base **S**

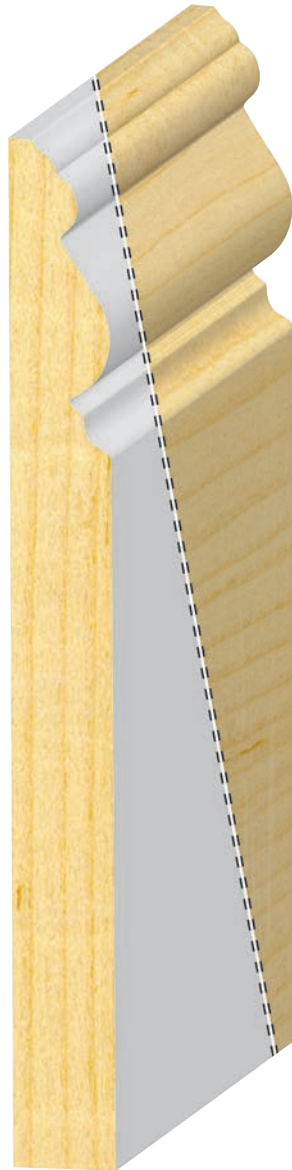

PR338FJ-5 9/16 x 5-7/16
Primed FJ
Santa Fe/#175 Base **N/S**

338FJ-5 9/16 x 5-7/16
Unprimed FJ #175 Base **S**



PR359FJ 9/16 x 5-7/16
Primed FJ
Classic Beaded Base **N/S**



5-1/2" to 6" Base

(items are approximate scale only)

✦ lengths available: 16' + trimbacks – Flexible moulding available for all profiles



PR387FJ-5 1/2 x 5-1/2
**Primed FJ 1 Eased Edge
Craftsman Base** N/S



PR387FJ-6 5/8 x 6
**Primed FJ 1 Eased Edge
Craftsman Base** N/S
[FORMERLY PR383A]

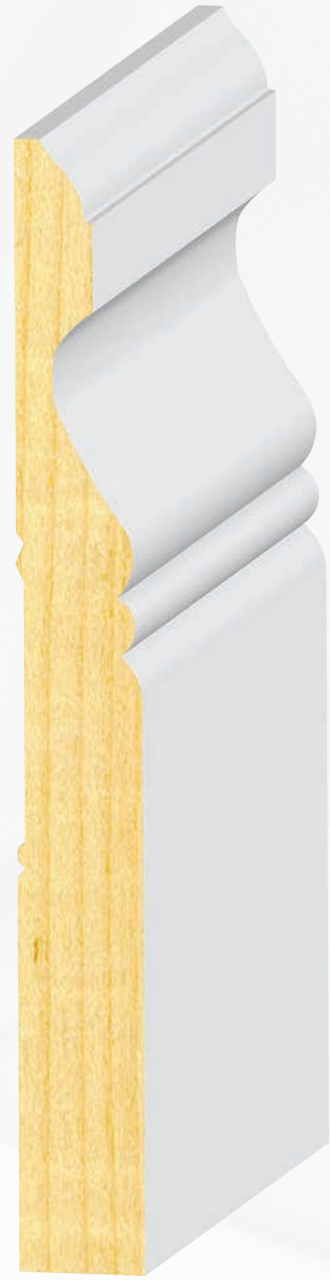

PR385FJ 1/2 x 6
**Primed FJ
Carolina/Palisade Base** N/S



(items are approximate scale only)

7-1/4" Base

✂ lengths available: 16' + trimbacks — Flexible moulding available for all profiles

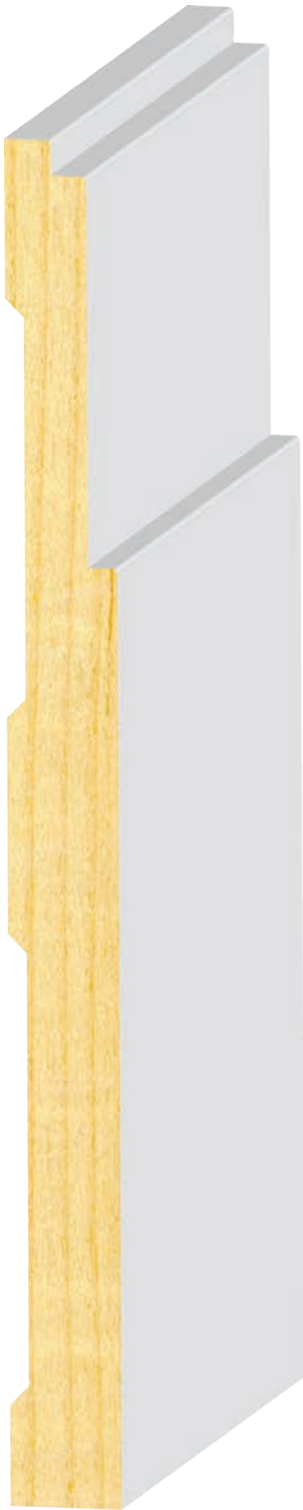

PR349FJ-7 5/8 x 7-1/4
Primed FJ
Meridian Base **N/S**



PR361FJ-7 11/16 x 7-1/4
Primed FJ
Monterey/Sonoma Base **N/S**



PR372FJ-7 9/16 x 7-1/4
Primed FJ
Contemporary Base **N/S**



1-5/8" to 2-3/4" Crown

(items are approximate scale only)

✂ lengths available: 16' + trimbacks – Flexible moulding available for all profiles

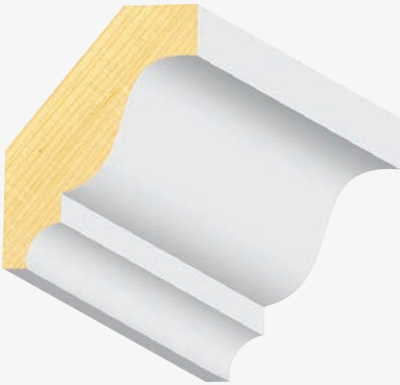

PR400FJ 9/16 x 1-5/8
Primed FJ Colonial Crown N/S

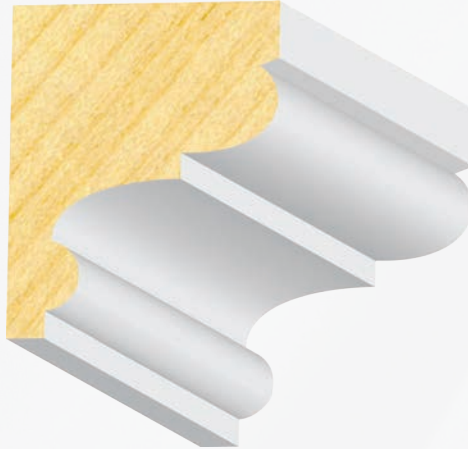

PR452FJ 1-7/16 x 1-3/4
Primed FJ Bed/Cabinet Crown N/S

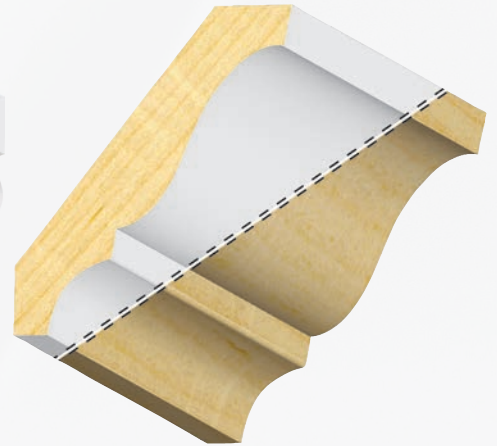

PR404FJ 9/16 x 2-1/4
Primed FJ Colonial Crown N/S
404FJ 9/16 x 2-1/4
Unprimed FJ Colonial Crown S

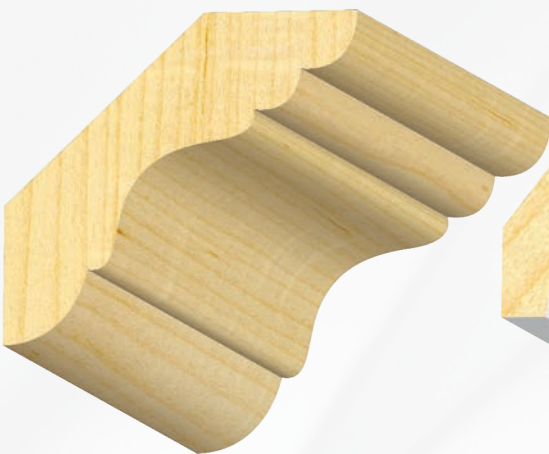

402FJ 11/16 x 2-1/2
Unprimed FJ Cornice S

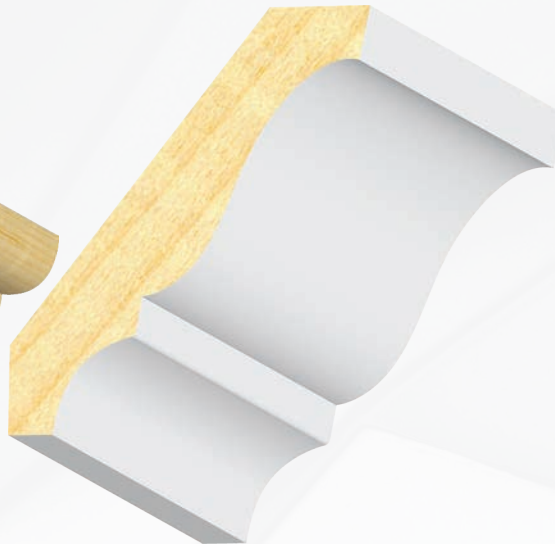

PR436FJ 9/16 x 2-3/4
Primed FJ Colonial Crown N

(items are approximate scale only)

3-1/8" to 3-3/8" Crown

✂ lengths available: 16' + trimbacks – Flexible moulding available for all profiles

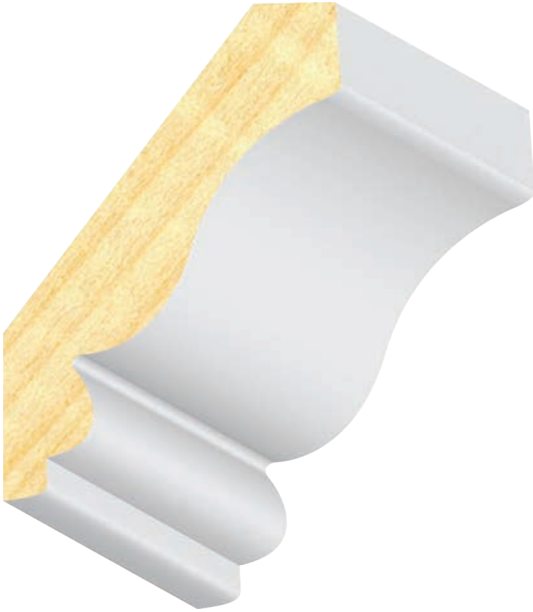

PR453FJ 9/16 x 3-1/8
Primed FJ Edge Bead Crown N

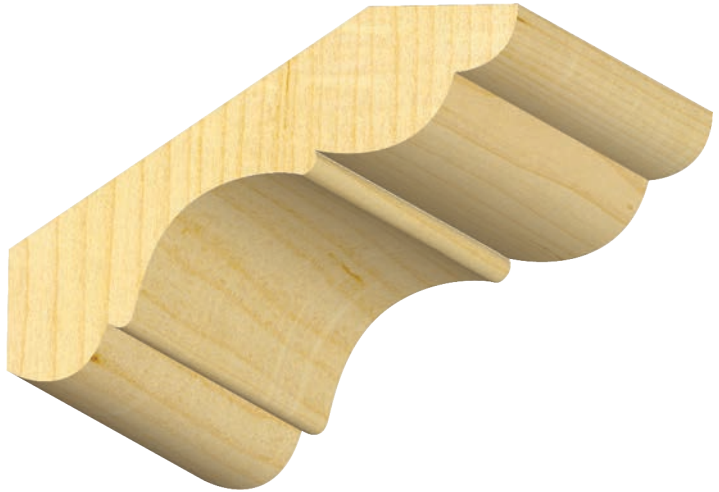

413FJ 11/16 x 3-1/4
Unprimed FJ Cornice S



PR441FJ 11/16 x 3-1/4
Primed FJ Single Beaded Crown N

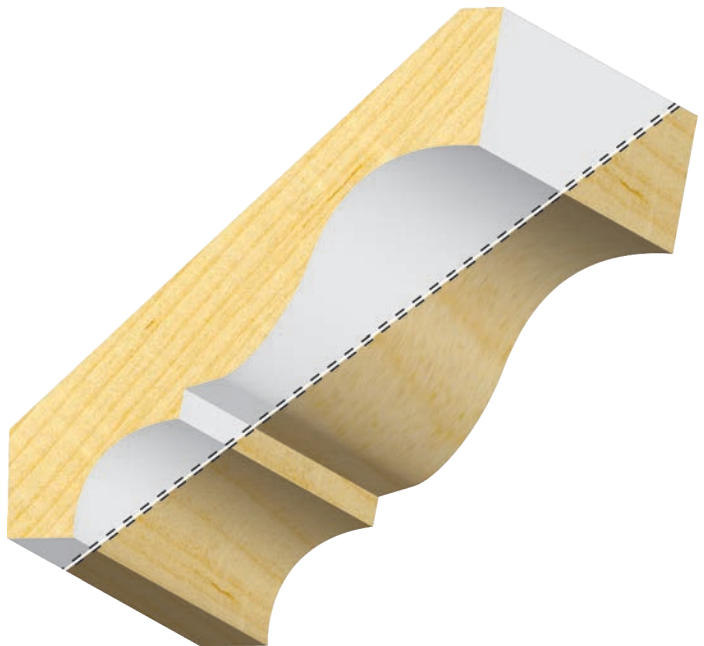

PR405FJ 9/16 x 3-3/8
Primed FJ Colonial Crown N/S

405FJ 9/16 x 3-3/8
Unprimed FJ Colonial Crown S

3-7/16" to 4-1/8" Crown

(items are approximate scale only)

✂ lengths available: 16' + trimbacks – Flexible moulding available for all profiles



PR421FJ 11/16 x 3-7/16
Primed FJ Double Bead Carolina Crown N/S

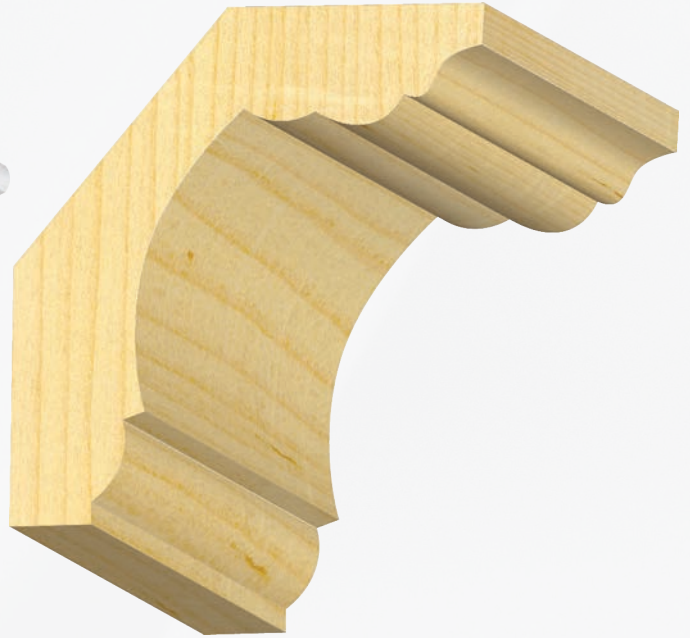

451FJ 1-1/4 x 3-9/16
Unprimed FJ Cornice S

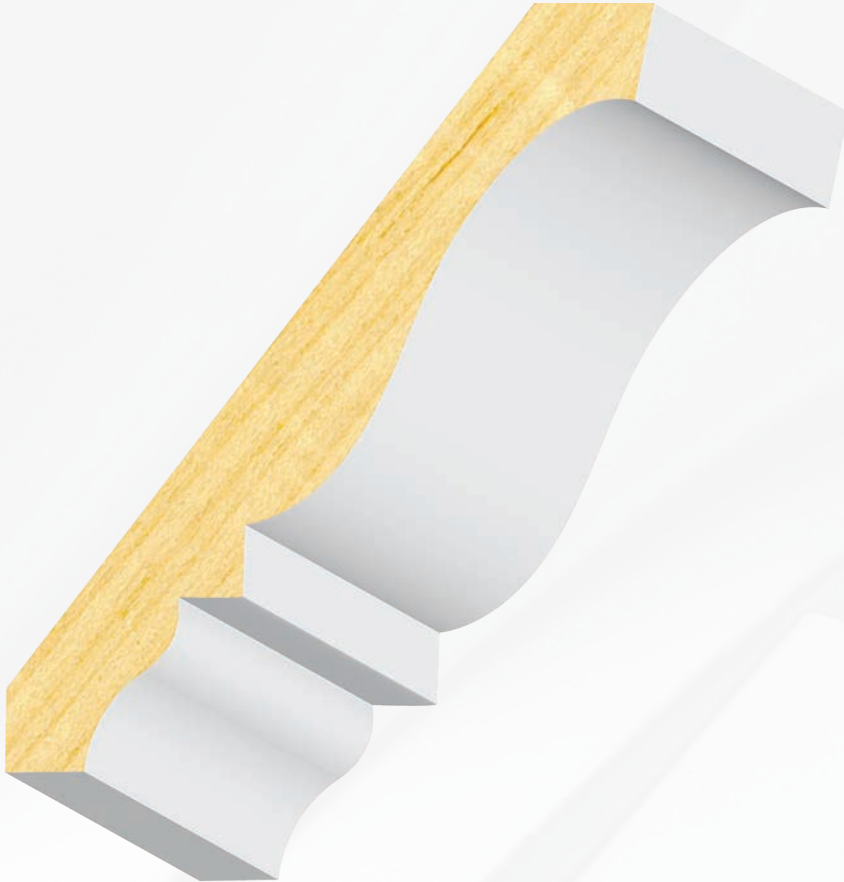

PR448FJ-4 9/16 x 4-1/8
Primed FJ Cape Cod Crown N



(items are approximate scale only)

4-3/8" Crown

✦ lengths available: 16' + trimbacks – Flexible moulding available for all profiles

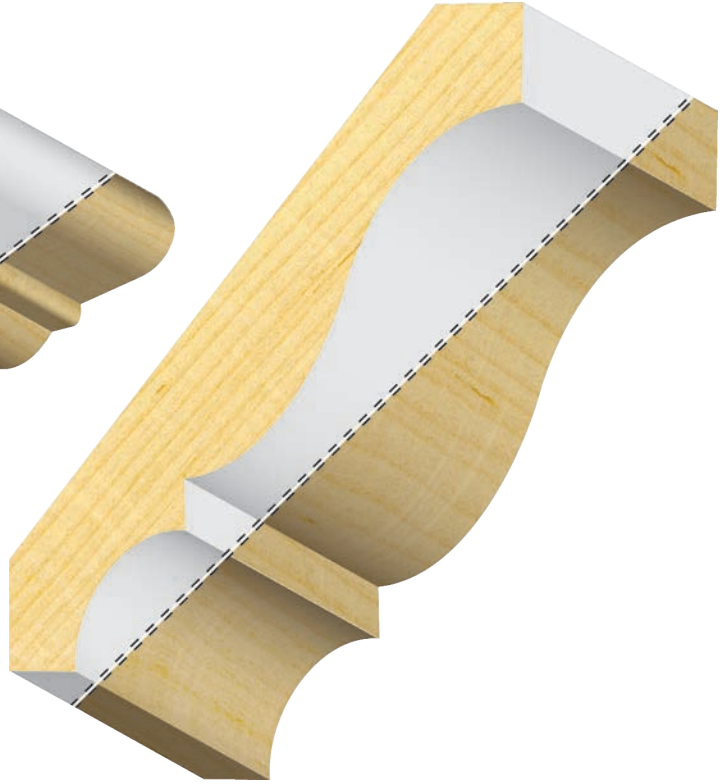
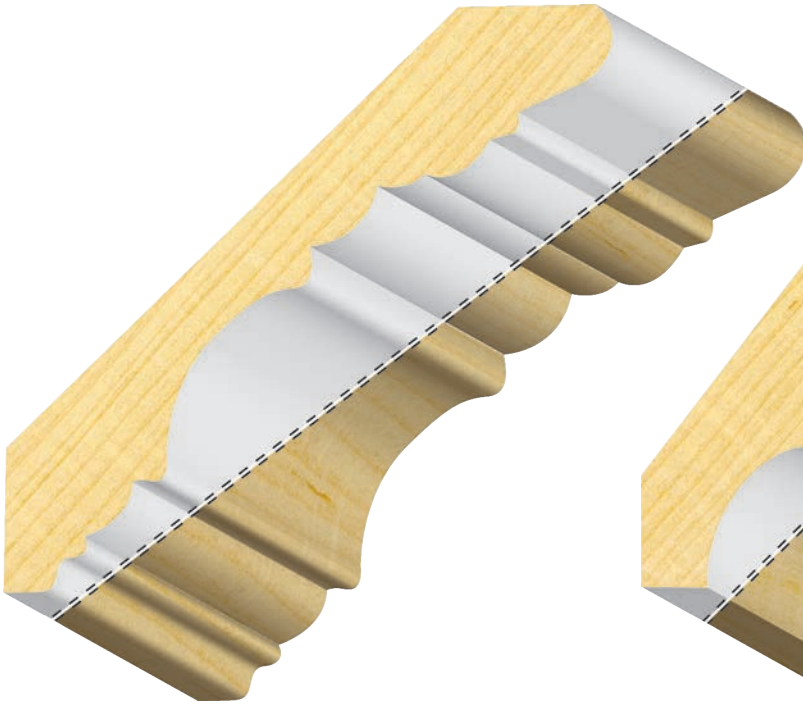

| | | | |
|----------------|---------------|-----------------------------------|----------|
| PR434FJ | 5/8 x 4-3/8 | Primed FJ Coronado Crown | N |
| 412FJ | 11/16 x 4-1/4 | Unprimed FJ Georgian Crown | S |

| | | | |
|----------------|--------------|-----------------------------------|------------|
| PR406FJ | 9/16 x 4-3/8 | Primed FJ Colonial Crown | N/S |
| 406FJ | 9/16 x 4-3/8 | Unprimed FJ Colonial Crown | S |



| | | | |
|------------------|-------------|---|------------|
| PR410FJ-4 | 5/8 x 4-3/8 | Primed FJ Small Charleston Crown | N/S |
|------------------|-------------|---|------------|



4-1/2" Crown

(items are approximate scale only)

✂ lengths available: 16' + trimbacks – Flexible moulding available for all profiles

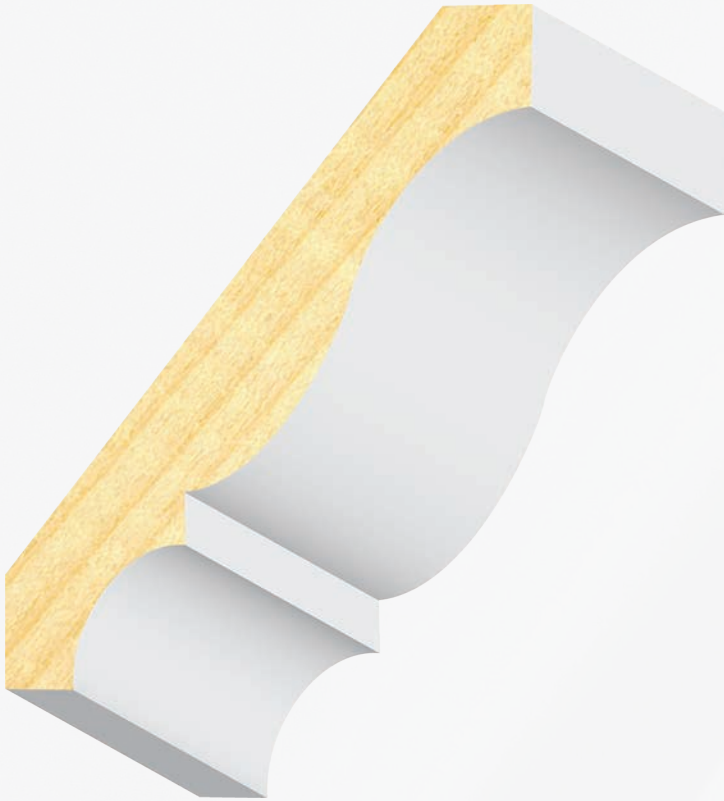

PR416FJ 11/16 x 4-1/2
Primed FJ Colonial Crown N

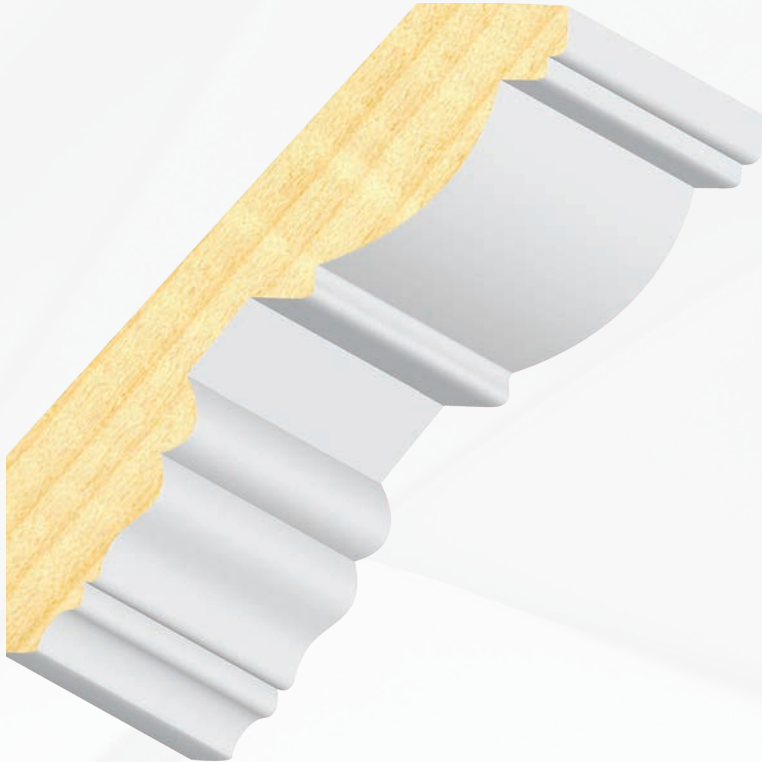

PR430FJ-4 11/16 x 4-1/2
Primed FJ Monterey Crown N/S



(items are approximate scale only)

4-1/2" to 4-5/8" Crown

✂ lengths available: 16' + trimbacks – Flexible moulding available for all profiles



PR407FJ 1-1/8 x 4-1/2
Primed FJ Cornice **N**

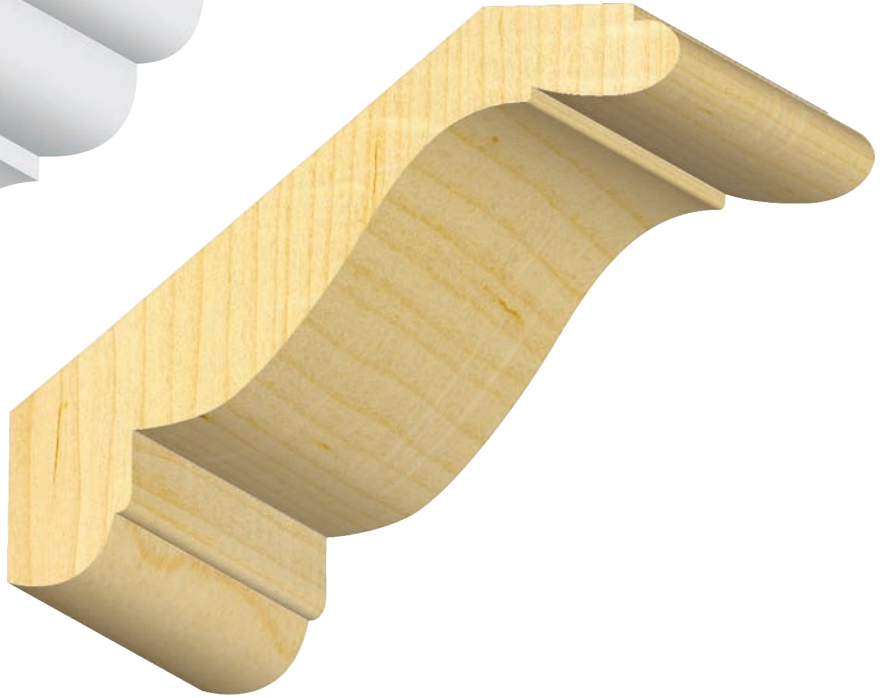

409FJ 11/16 x 4-5/8
Unprimed FJ Rancho Crown **S**

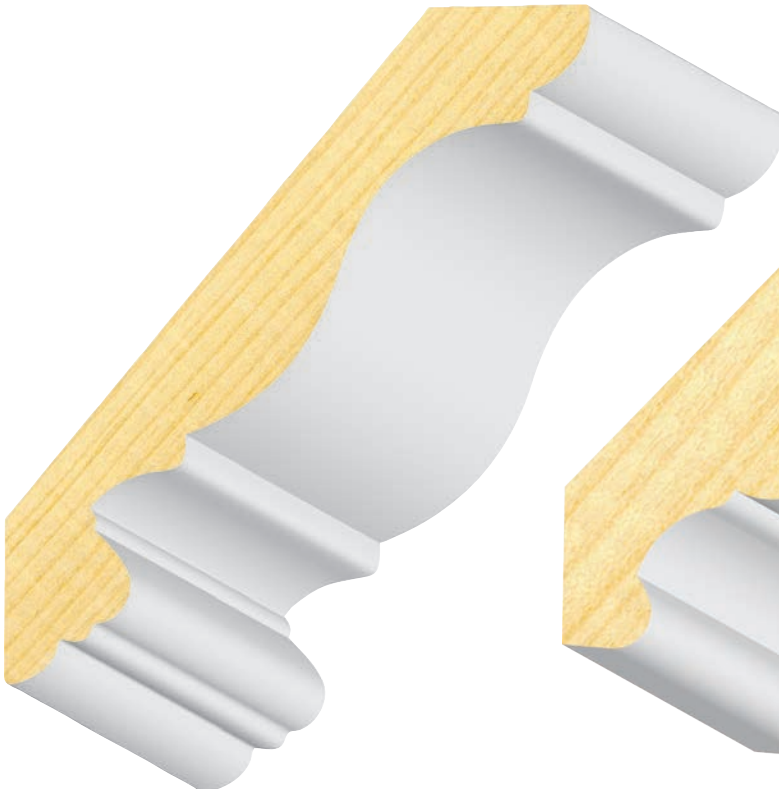

PR411FJ-4 11/16 x 4-5/8
Primed FJ Rafael Crown **N/S**

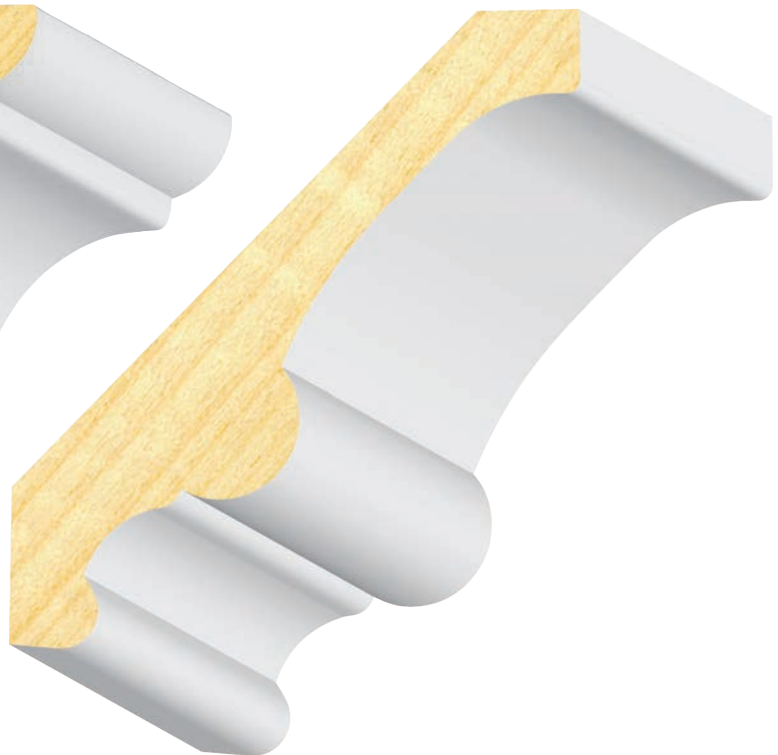

PR442FJ 11/16 x 4-5/8
Primed FJ Single Beaded Crown **N**



4-15/16" to 5" Crown

(items are approximate scale only)

✂ lengths available: 16' + trimbacks – Flexible moulding available for all profiles



PR423FJ 7/8 x 4-15/16
Primed FJ Double Bead Carolina Crown N/S



PR418FJ 5/8 x 5
Primed FJ Montecito Crown N/S

(items are approximate scale only)

5-1/4" Crown

lengths available: 16' + trimbacks – Flexible moulding available for all profiles

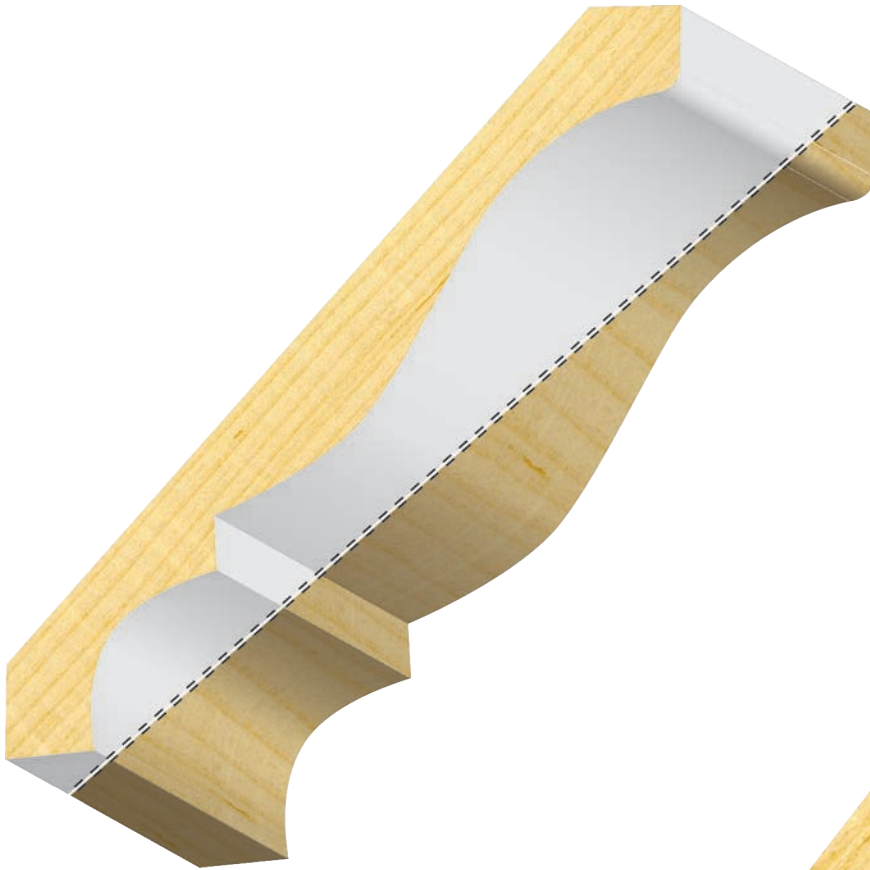

| | | | |
|----------------|---------------|-----------------------------------|------------|
| PR414FJ | 9/16 x 5-1/4 | Primed FJ Colonial Crown | N/S |
| PR415FJ | 11/16 x 5-1/4 | Primed FJ Colonial Crown | N |
| 414FJ | 9/16 x 5-1/4 | Unprimed FJ Colonial Crown | S |

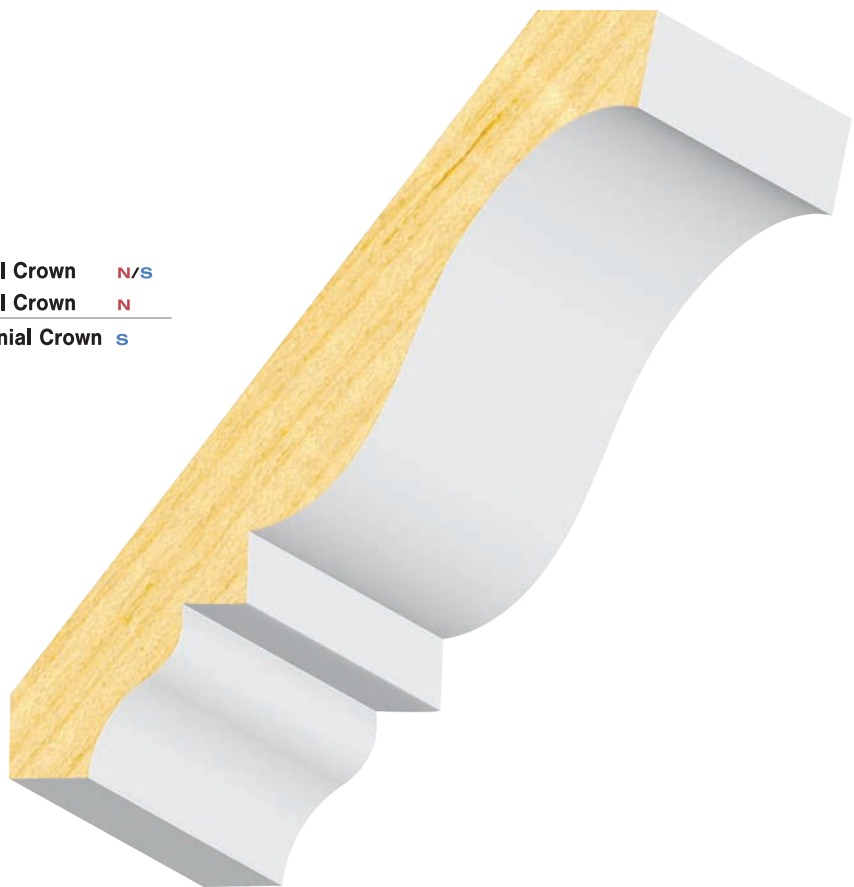

PR448FJ-5 9/16 x 5-1/4 **Primed FJ Cape Cod Crown** **N**

5-1/4" Crown

✂ lengths available: 16' + trimbacks – Flexible moulding available for all profiles

(items are approximate scale only)

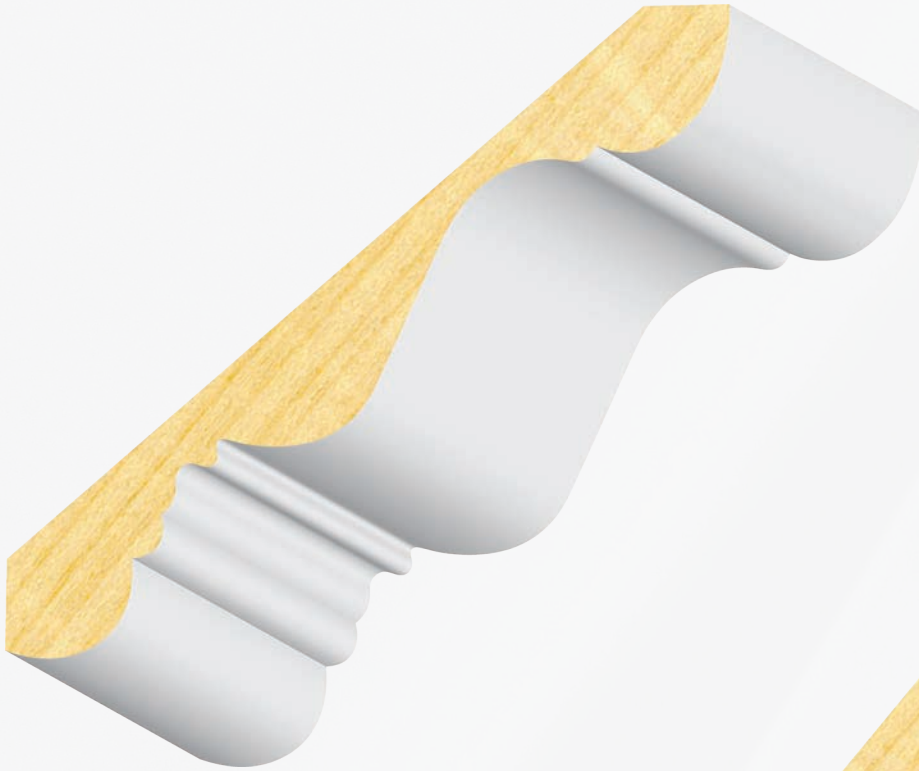

PR410FJ-5 11/16 x 5-1/4
Primed FJ Charleston Crown N/S



PR411FJ-5 11/16 x 5-1/4
Primed FJ Rafael Crown N/S



(items are approximate scale only)

5-1/4" Crown

✂ lengths available: 16' + trimbacks – Flexible moulding available for all profiles

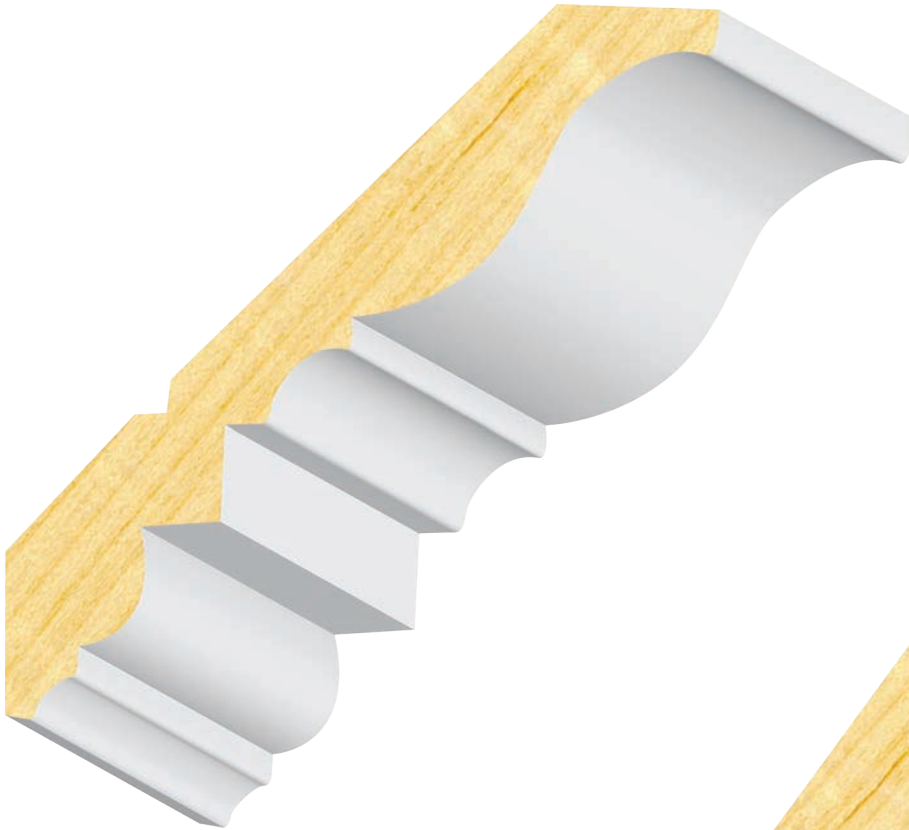

PR419FJ 11/16 x 5-1/4
Primed FJ Georgian Crown N/S



PR430FJ-5 11/16 x 5-1/4
Primed FJ Monterey Crown N/S



6" Crown

(items are approximate scale only)

✂ lengths available: 16' + trimbacks – Flexible moulding available for all profiles

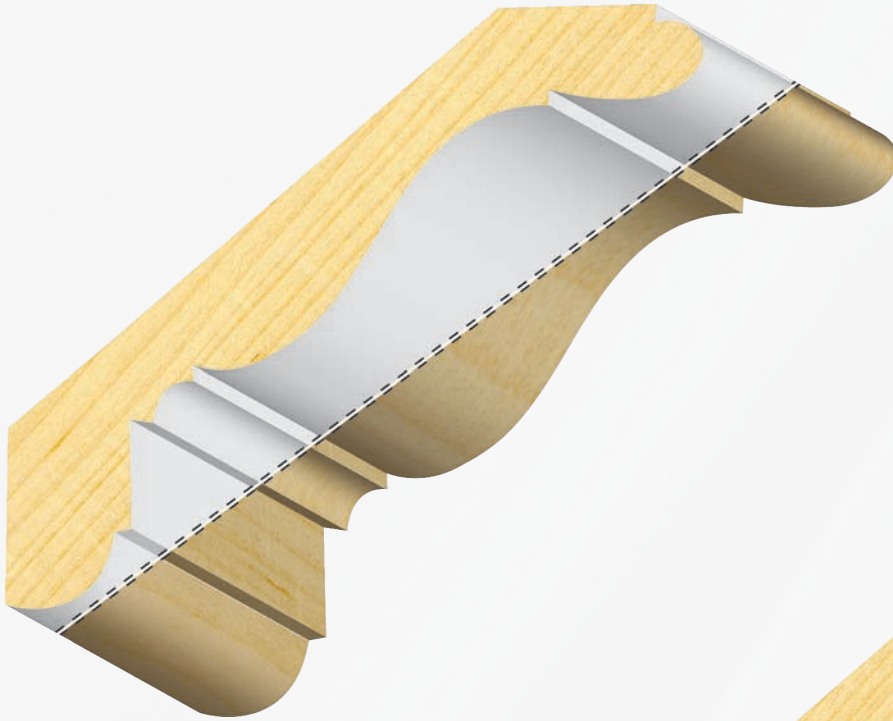

- PR408FJ** 1-1/4 x 6
Primed FJ Cornice N

- 408FJ** 1-1/4 x 5-3/4
Unprimed FJ Cornice S



- PR410FJ-6** 11/16 x 6
Primed FJ Charleston Crown N/S

- 410FJ-6** 5/8 x 6
Unprimed FJ Charleston Crown S



(items are approximate scale only)

6-5/16" to 6-3/8" Crown

lengths available: 16' + trimbacks – Flexible moulding available for all profiles



PR411FJ-6 1-1/16 x 6-5/16
Primed FJ Rafael Crown *N/S*

PR448FJ-6 11/16 x 6-3/8
Primed FJ Cape Cod Crown *N*



6-1/2" Crown

(items are approximate scale only)

✂ lengths available: 16' + trimbacks – Flexible moulding available for all profiles



PR430FJ-6 7/8 x 6-1/2
Primed FJ Monterey Crown N/S



(items are approximate scale only)

6-9/16" Crown

✂ lengths available: 16' + trimbacks – Flexible moulding available for all profiles

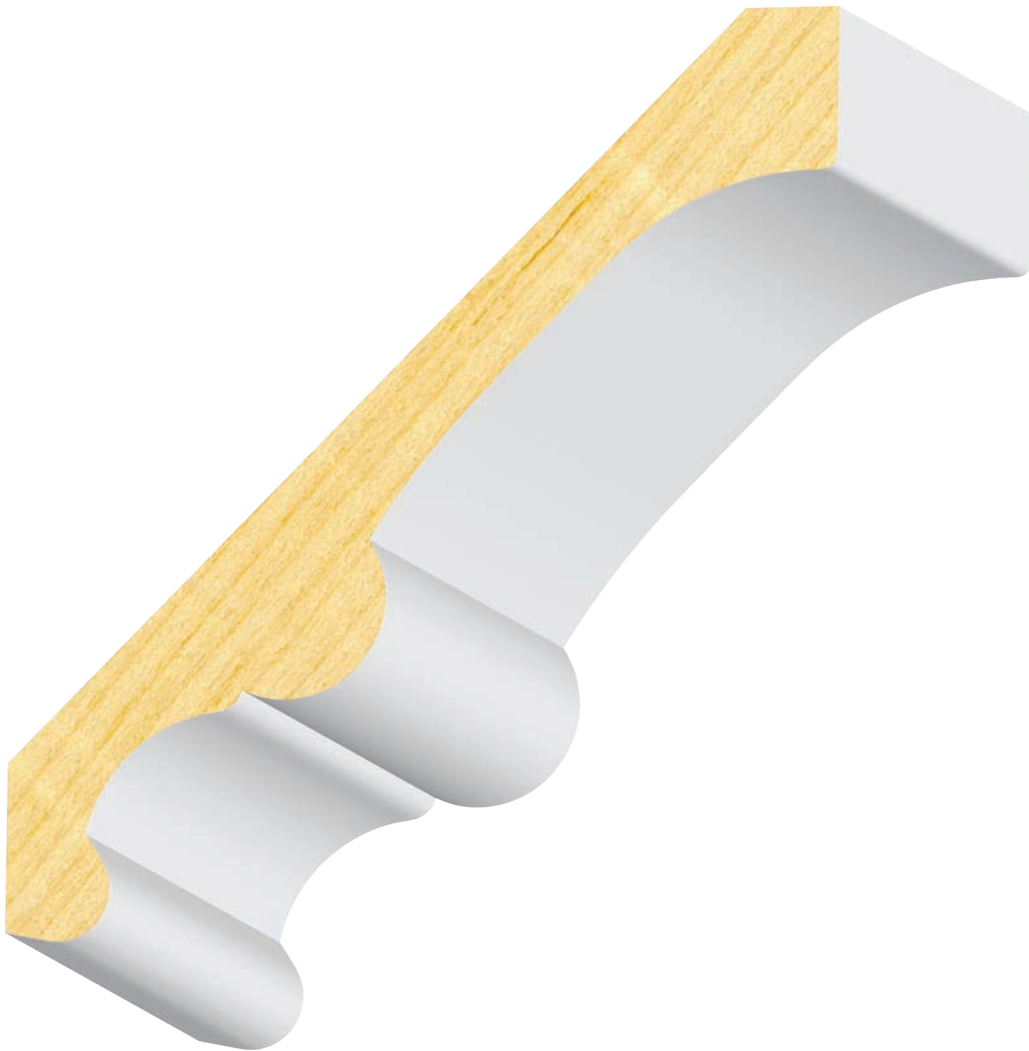

PR443FJ 7/8 x 6-9/16
Primed FJ Single Beaded Crown N

7-3/16" Crown

(items are approximate scale only)

✂ lengths available: 16' + trimbacks – Flexible moulding available for all profiles



PR424FJ-7 1-1/8 x 7-3/16
Primed FJ Double Bead Carolina Crown N/S



(items are approximate scale only)

7-1/4" Crown

✦ lengths available: 16' + trimbacks – Flexible moulding available for all profiles



PR417FJ 7/8 x 7-1/4
Primed FJ Colonial Crown N/S



Chair Rail

✂ lengths available: 16' + trimbacks

(items are approximate scale only)



PR657FJ 11/16 x 2-1/8
**Primed FJ
 Chair Rail** N

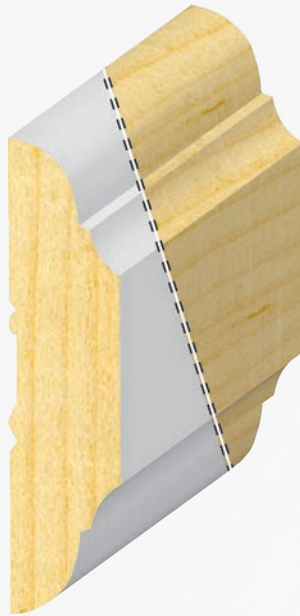

PR651FJ 9/16 x 2-1/2
**Primed FJ
 Chair Rail** N/S



PR655FJ 5/8 x 2-5/8
**Primed FJ
 Coronado Chair Rail** N

651FJ 9/16 x 2-1/2
**Unprimed FJ
 Chair Rail** S



PR671FJ 9/16 x 4-3/8
**Primed FJ
 Chair Rail Backer** S
 (with 3-1/4" Face)



649FJ 11/16 x 3
**Unprimed FJ
 Bead & Barrel
 Chair Rail** S

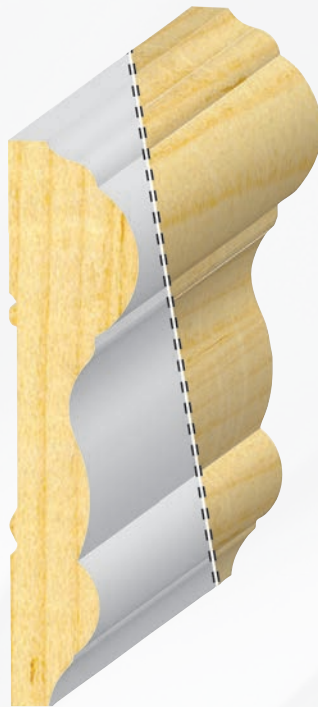

PR653FJ 11/16 x 3
**Primed FJ
 Chair Rail** N/S

653FJ 11/16 x 3
**Unprimed FJ
 Chair Rail** S



PR670FJ 9/16 x 3-1/2
**Primed FJ
 Chair Rail Backer** S
 (with 2-9/16" Face)



Cove / Quarter Round

✦ lengths available: 16'+ trimbacks

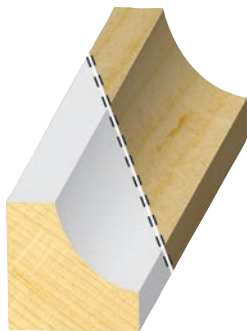

PR523FJ 11/16 x 11/16
Primed FJ Cove N/S
523FJ 11/16 x 11/16
Unprimed FJ Cove S



PR504FJ 11/16 x 11/16
Primed FJ Quarter Round N/S
504FJ 11/16 x 11/16
Unprimed FJ Quarter Round S

Full Round

✦ lengths available: 16'+ trimbacks



802FJ 1-1/4
Unprimed FJ Full Round N/S

Flat Astragal

✦ lengths available: 7', 8' & 16'



PR646FJ 11/16 x 1-5/8 **Primed FJ Flat Astragal/Panel Mold** N
PR660FJ 11/16 x 1-5/8 **Primed FJ Flat Astragal/Panel Mold** S
660FJ 11/16 x 1-5/8 **Unprimed FJ Flat Astragal/Panel Mold** S

T-Astragal

✦ lengths available: 7' and 8'



662FJ 1-1/4 x 2
Unprimed FJ T-Astragal N/S
[for 1-3/8" Door]



661FJ 1-1/4 x 2-1/4
Unprimed FJ T-Astragal S
 ✦ lengths available: 7' & 8'
[for 1-3/4" Door]

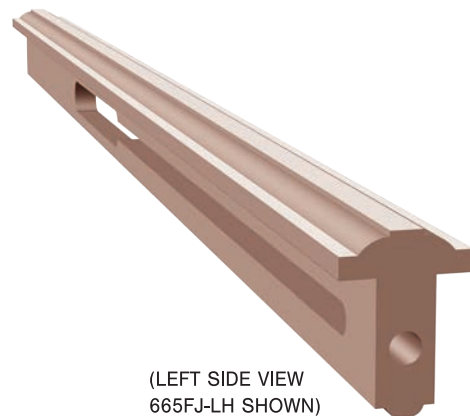

(LEFT SIDE VIEW
 665FJ-LH SHOWN)

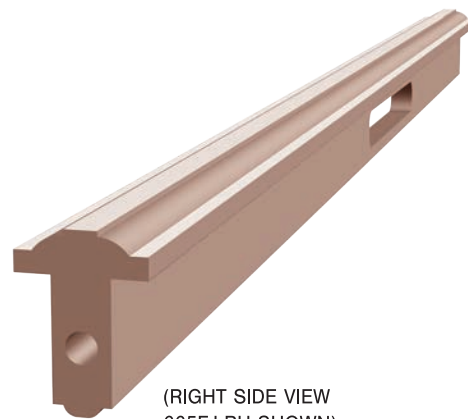

(RIGHT SIDE VIEW
 665FJ-RH SHOWN)

665FJ-LH 1-1/2 x 2 (indicate LH) FACES ACTIVE DOOR
665FJ-RH 1-1/2 x 2 (indicate RH) FACES ACTIVE DOOR
Unprimed FJ T-Astragal S
 ✦ lengths available: 8' only
[for 1-3/8" Door]

Panel Mold

lengths available: 16' + trimbacks

(items are approximate scale only)



PR600FJ 9/16 x 3/4
Primed FJ Panel Mold N/S

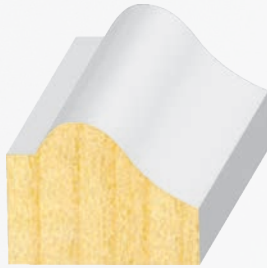

PR602FJ 3/4 x 1
Primed FJ Panel Mold N/S



PR609FJ 7/16 x 1-1/8
Primed FJ Panel Mold N/S

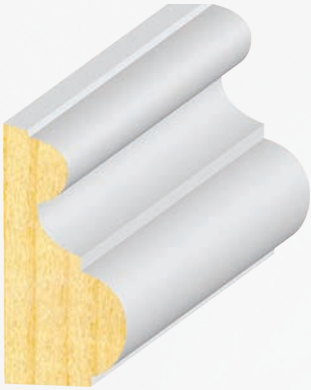

PR603FJ 11/16 x 1-3/8
Primed FJ Panel Mold N/S

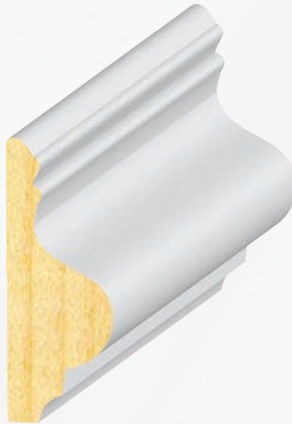

PR601FJ 9/16 x 1-1/2
Primed FJ Panel Mold N

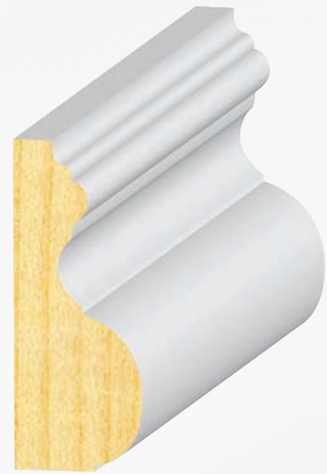

PR604FJ 11/16 x 1-3/4
Primed FJ Panel Mold N/S



PR605FJ 11/16 x 1-5/8
Primed FJ Panel Mold S

605FJ 11/16 x 1-5/8
Unprimed FJ Panel Mold S

(items are approximate scale only)

Panel Mold & Cap

lengths available: 16' + trimbacks



PR614FJ 11/16 x 1-3/8
Primed FJ Coronado Base/Panel Cap N/S

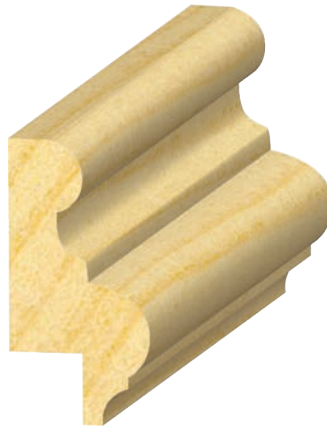

620FJ 3/4 x 1-1/2
Unprimed FJ Panel Cap S
[with 3/8" Rab't]

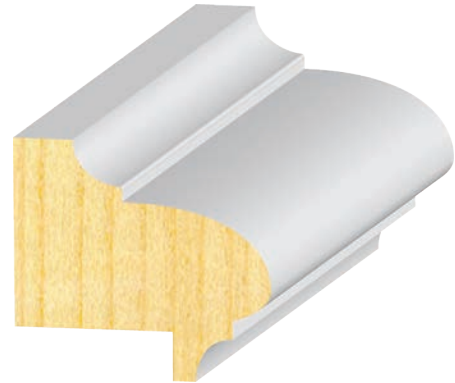

PR626FJ 1-3/16 x 1-3/8
Primed FJ Panel Cap N/S
[with 1/4 x 3/4 Rabbet]

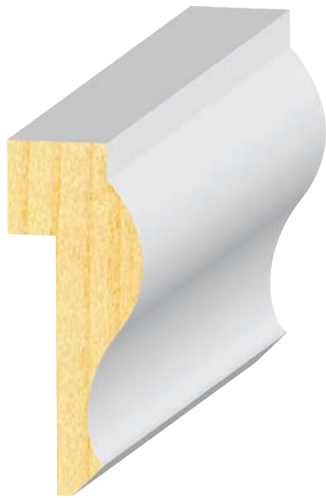

PR625FJ 11/16 x 2
Primed FJ Large Cap N
[with 3/16 x 1-3/8 Rabbet]

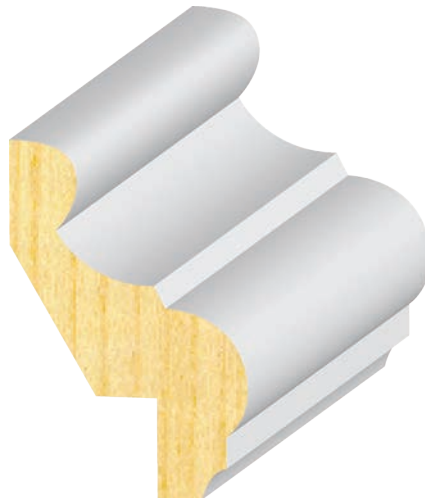

PR621FJ 3/4 x 2
Primed FJ T&G Wainscot Cap S
[with 3/4" Rab't]

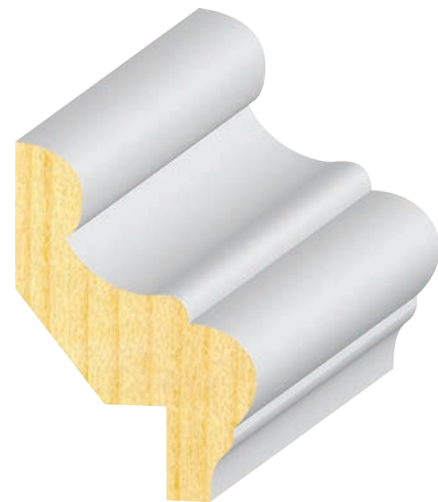

PR620BFJ 11/16 x 2-1/8
Primed FJ Coronado Wainscot Cap N/S
[with 3/8 x 5/8 Rab't]



Panel Mold

✦ lengths available: 16' + trimbacks

(items are approximate scale only)

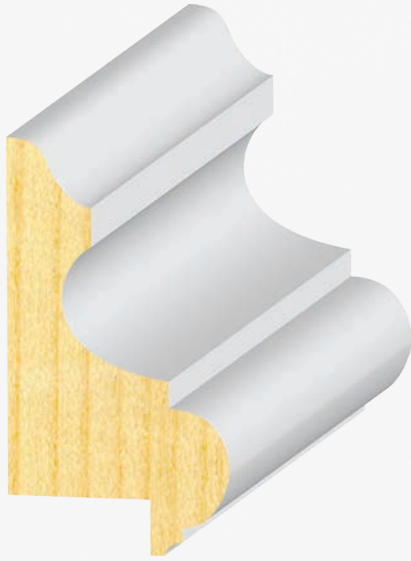

PR613FJ 1-3/16 x 2-3/16
Primed FJ Raised Panel Cap N/S
 [with 5/16 x 11/16 Rab't]



PR627FJ 11/16 x 2-3/8
Primed FJ Colonial Cap N/S



PR628FJ 11/16 x 2-7/16
Primed FJ Victorian Cap N/S

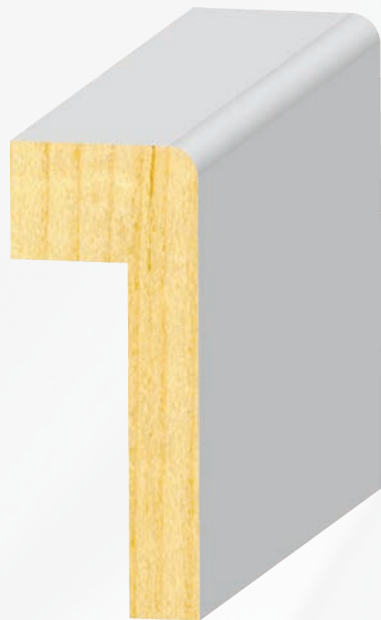

PR740FJ 1 x 2-1/2
Primed FJ Contemporary Panel Cap N/S
 [with 5/8" Rab't]



PR623FJ 1-9/16 x 2-5/8
Primed FJ Craftsman Cap N/S
 [with 3/4" Rab't]

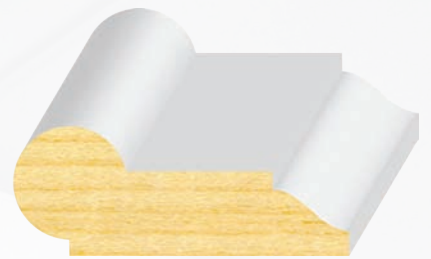

PR916FJ 11/16 x 1-3/4
Primed FJ Picture Mold N/S

(items are approximate scale only)

Apron

✦ lengths available: 16" + trimbacks



301FJ 7/16 x 1-1/2
Unprimed FJ Flat Base/Apron N/S



902FJ 3/8 x 1-1/2
Unprimed FJ Apron S
 Other options for apron are casing or base underneath a window stool.

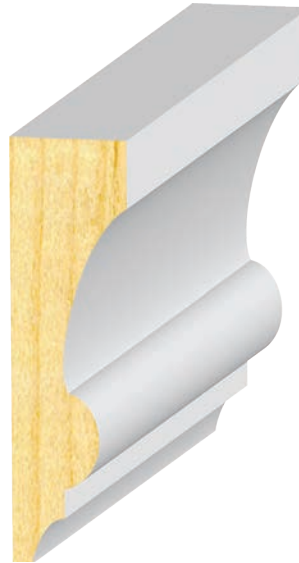

PR904FJ 5/8 x 2-1/4
Primed FJ Apron N/S



PR996FJ 1-1/16 x 2 **Primed FJ Window Stool** N

Window Stool



980FJ 11/16 x 4-3/4 **Unprimed FJ Flat Stool** S
979FJ 11/16 x 5-1/2 **Unprimed FJ Flat Stool** S
985FJ 11/16 x 7-1/4 **Unprimed FJ Flat Stool** S

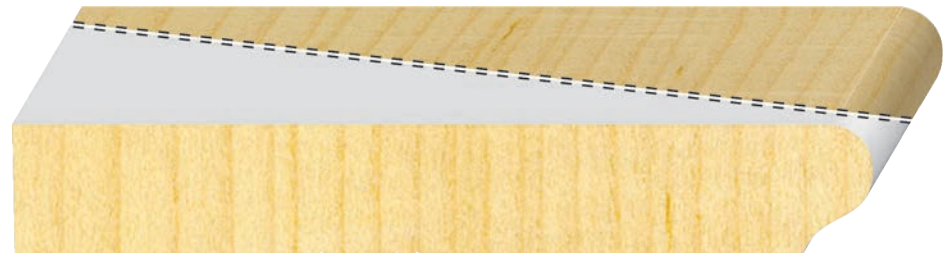

PR990FJ 11/16 x 4-1/2 **Primed FJ Ogee Window Stool** N
990FJ 11/16 x 4-1/2 **Unprimed FJ Ogee Window Stool** N
PR992FJ 11/16 x 5-1/4 **Primed FJ Ogee Window Stool** N
992FJ 11/16 x 5-1/4 **Unprimed FJ Ogee Window Stool** N
993FJ 11/16 x 6-1/2 **Unprimed FJ Ogee Window Stool** N
PR994FJ 11/16 x 7-1/4 **Primed FJ Ogee Window Stool** N
994FJ 11/16 x 7-1/4 **Unprimed FJ Ogee Window Stool** N

Hook & Cleat

(items are approximate scale only)



10FJ 9/16 x 1-1/2
Unprimed FJ
1 Eased Edge Cleat N/S

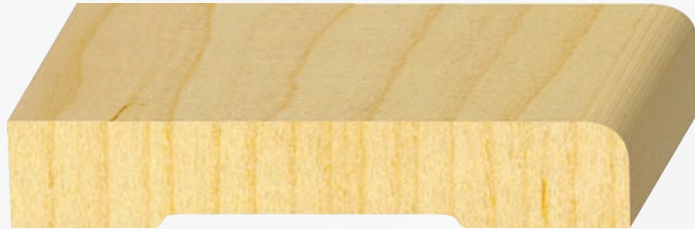

15FJ 9/16 x 3-1/4 **Unprimed FJ 1 Eased Edge Hookstrip** N/S



16FJ 11/16 x 4-1/2
Unprimed FJ Hookstrip N
[with 5/16 x 3/4" Rab't]

Nosing

lengths available: 16' + trimbacks



PR913FJ 1-1/8 x 1-7/16 **Primed FJ Nosing** N

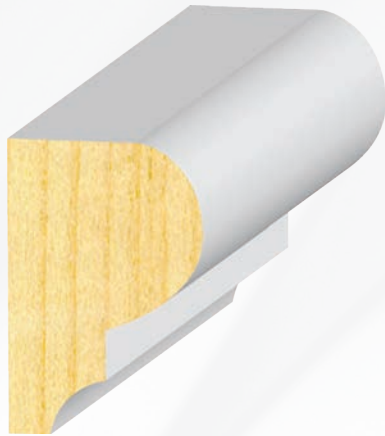

PR909FJ 1-1/4 x 1-3/4 **Primed FJ Nose & Cove** N

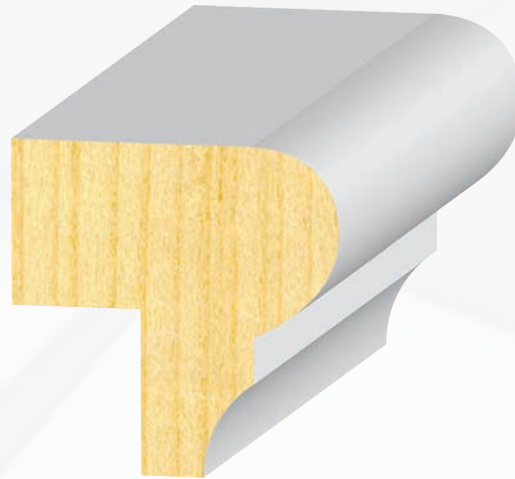

PR910FJ 1-3/4 x 1-3/4 **Primed FJ Nose & Cove** N
[with 11/16" x 11/16" Rab't]

PR910BFJ 1-3/4 x 1-3/4 **Primed FJ Nose & Cove** N
[with 11/16" x 7/8" Rab't]



(items are approximate scale only)

Exterior Brick & Stucco Mold

✂ lengths available: 7', 17'+ trimbacks

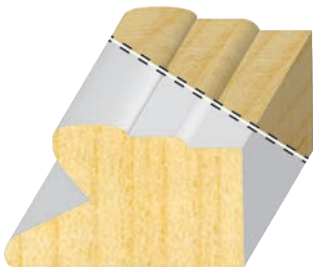

PR953FJ 3/4 x 1-1/4
Primed FJ Stucco Mold S

953FJ 3/4 x 1-1/4
Unprimed FJ Stucco Mold S

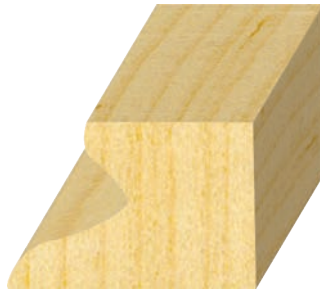

954FJ 7/8 x 1-3/16
Unprimed FJ Flat Stucco Mold S

(Perfect for nailing 1x trim around a door or window when stucco is used)

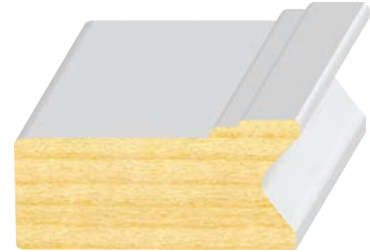

PR833FJ 13/16 x 1-1/2
Primed FJ Stucco N

PR833BFJ 11/16 x 1-1/2
Primed FJ Thin Stucco N

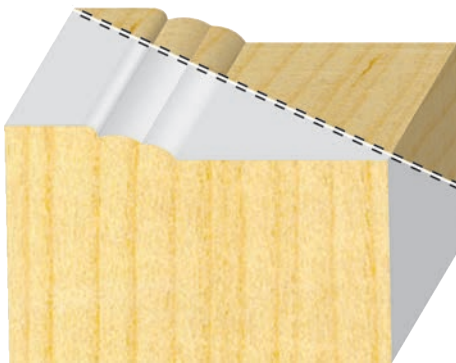

PR612AFJ 1-1/4 x 2
Primed FJ #180 Eastern Brick Mold N/S
without Stucco Key

612AFJ 1-1/4 x 2
Unprimed FJ #180 Eastern Brick Mold N/S
without Stucco Key



PR612BFJ 1-1/4 x 2
Primed FJ #180 Eastern Brick Mold N/S
with Stucco Key

612BFJ 1-1/4 x 2
Unprimed FJ #180 Eastern Brick Mold N/S
with Stucco Key



636FJ-1 11/16 x 1-5/8
Unprimed FJ Arizona Brick Mold S



636FJ-2 11/16 x 2-1/4
Unprimed FJ Arizona Brick Mold S



S4S

(NO WARRANTY PROVIDED ON EXTERIOR USE)

(items are approximate scale only)

UNTREATED S1S/S4S BOARDS



Unprimed S4S

(NO WARRANTY PROVIDED ON EXTERIOR USE)

| | | | |
|---------------------|----------------|------------------------|----------|
| 715FJ (1x4) | 11/16 x 3-1/2 | Unprimed FJ S4S | S |
| 750FJ (1x6) | 11/16 x 5-1/2 | Unprimed FJ S4S | S |
| 751FJ (1x8) | 11/16 x 7-1/4 | Unprimed FJ S4S | S |
| 753FJ (1x12) | 11/16 x 11-1/4 | Unprimed FJ S4S | S |

Primed S4S

(NON-PROTECTED)

(NO WARRANTY PROVIDED ON EXTERIOR USE)

| | | | |
|-----------------------|----------------|-----------------------------|----------|
| PR713FJ (1x2) | 11/16 x 1-1/2 | Double Primed FJ S4S | S |
| PR715FJ (1x4) | 11/16 x 3-1/2 | Double Primed FJ S4S | S |
| PR750FJ (1x6) | 11/16 x 5-1/2 | Double Primed FJ S4S | S |
| PR751FJ (1x8) | 11/16 x 7-1/4 | Double Primed FJ S4S | S |
| PR753FJ (1x12) | 11/16 x 11-1/4 | Double Primed FJ S4S | S |

16'

| | | | |
|-------------------------|----------------|------------------------|------------|
| 1x2S4S (1x2) | 3/4 x 1-1/2 | Primed FJ S4SSE | N/S |
| 1x3S4S (1x3) | 3/4 x 2-1/2 | Primed FJ S4SSE | N/S |
| 1x4S4S (1x4) | 3/4 x 3-1/2 | Primed FJ S4SSE | N/S |
| 1x6S4S (1x6) | 3/4 x 5-1/2 | Primed FJ S4SSE | N/S |
| 1x8S4S (1x8) | 3/4 x 7-1/4 | Primed FJ S4SSE | N/S |
| 1x10S4S (1x10) | 3/4 x 9-1/4 | Primed FJ S4SSE | N/S |
| 1x12S4S (1x12) | 3/4 x 11-1/4 | Primed FJ S4SSE | N/S |
| 5/4x4S4S (5/4x4) | 1-1/16 x 3-1/2 | Primed FJ S4SSE | N |
| 5/4x6S4S (5/4x6) | 1-1/16 x 5-1/2 | Primed FJ S4SSE | N |
| 5/4x8S4S (5/4x8) | 1-1/16 x 7-1/4 | Primed FJ S4SSE | N |

Primed S1S

(1 SIDE SMOOTH / 1 SIDE ROUGH HEWN)

(NO WARRANTY PROVIDED ON EXTERIOR USE)

| | | | |
|----------------------|-----------------|------------------------|------------|
| PR760FJ 1x2 | 23/32 x 1-1/2 | Primed FJ S1S2E | N/S |
| PR761FJ 1x3 | 23/32 x 2-1/2 | Primed FJ S1S2E | N/S |
| PR762FJ 1x4 | 23/32 x 3-1/2 | Primed FJ S1S2E | N/S |
| PR763FJ 1x6 | 23/32 x 5-1/2 | Primed FJ S1S2E | N/S |
| PR764FJ 1x8 | 23/32 x 7-1/4 | Primed FJ S1S2E | N/S |
| PR765FJ 1x10 | 23/32 x 9-1/4 | Primed FJ S1S2E | N/S |
| PR766FJ 1x12 | 23/32 x 11-1/4 | Primed FJ S1S2E | N/S |
| PR767FJ 5/4x4 | 1-1/8 x 3-1/2 | Primed FJ S1S2E | N/S |
| PR768FJ 5/4x6 | 1-1/8 x 5-1/2 | Primed FJ S1S2E | N/S |
| PR769FJ 5/4x8 | 1-1/8 x 7-1/4 | Primed FJ S1S2E | N/S |
| PR770FJ 2x2 | 1-7/16 x 1-1/2 | Primed FJ S1S2E | N/S |
| PR771FJ 2x4 | 1-7/16 x 3-1/2 | Primed FJ S1S2E | N/S |
| PR772FJ 2x6 | 1-7/16 x 5-1/2 | Primed FJ S1S2E | N/S |
| PR773FJ 2x8 | 1-7/16 x 7-1/4 | Primed FJ S1S2E | N/S |
| PR774FJ 2x10 | 1-7/16 x 9-1/4 | Primed FJ S1S2E | N/S |
| PR775FJ 2x12 | 1-7/16 x 11-1/4 | Primed FJ S1S2E | N/S |

FOR TREATED PRIMED FJ BOARDS, PLEASE REFER TO BODYGUARD TRIMBOARDS & SIDINGS SECTION.

Wainscot

lengths available: 16' + trimbacks

(items are approximate scale only)



PR2000FJ 3/8 x 3-7/8 **Primed FJ Beaded T&G Wainscot** N/S
2000FJ 3/8 x 3-3/8 **Unprimed FJ Beaded T&G Wainscot** S

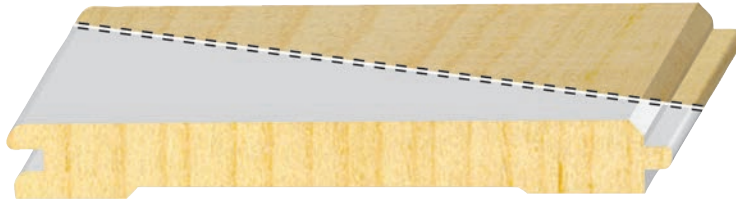

PR2001FJ 3/8 x 3-1/4 **Primed FJ Flat T&G Wainscot** N/S
2001FJ 3/8 x 3-1/4 **Unprimed FJ Flat T&G Wainscot** S



PR734FJ 3/4 x 2-5/16 **Primed FJ Wainscot Cap** N
(with 1/4" x 1" Rab't)
(use with PR2000FJ and PR2001FJ)

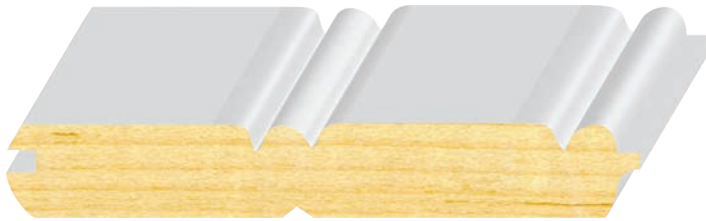

PR2004FJ 1/2 x 3-5/16
Primed FJ Reversible Beaded V-Groove T&G Wainscot N

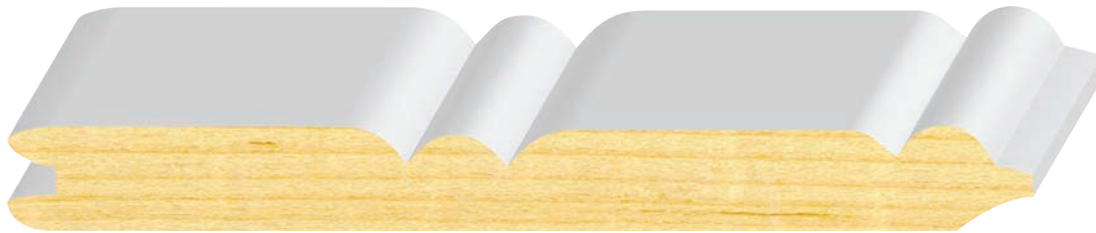

PR2002FJ 9/16 x 5-3/8 **Primed FJ Beaded T&G Wainscot** S



PR2003FJ 3/4 x 5-3/8 **Primed FJ Flat V-Groove T&G Ceiling Panel** N/S



PR2007FJ 5/8 x 5-1/2 **Primed FJ Reversible V-Groove/Nickel Gap T&G** N/S *(1 SIDE NICKEL GAP / 1 SIDE V-GROOVE)*



Wainscot

(items are approximate scale only)

✂ lengths available: 16' + trimbacks



PR2008FJ 5/8 x 7-1/8 **Primed FJ Reversible V-Groove/Nickel Gap T&G Wainscot** N/S (1 SIDE V-GROOVE / 1 SIDE NICKEL GAP)

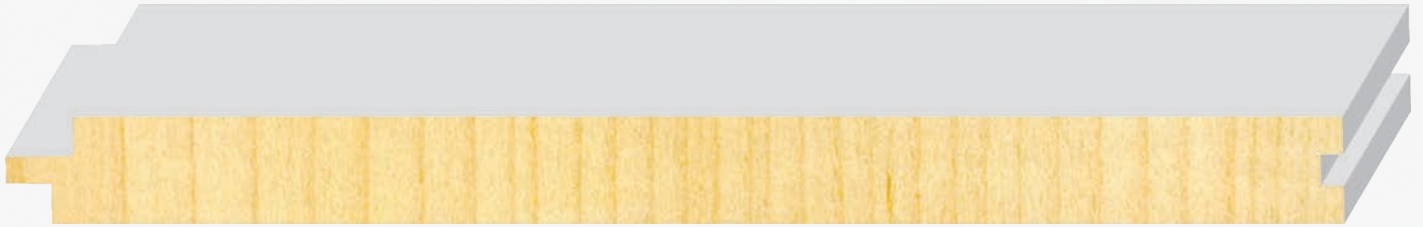

PR2009FJ 5/8 x 7-1/8 **Primed FJ Reversible Single/Double Nickel Gap T&G Wainscot** N/S

Exterior Double Rabetted Door Frames

✂ lengths available: all 6' thru 16'

Rabbeted 1/2" x 1-7/16"
(1-3/8" DOOR)

Rabbeted 1/2" x 1-13/16"
(1-3/4" DOOR)

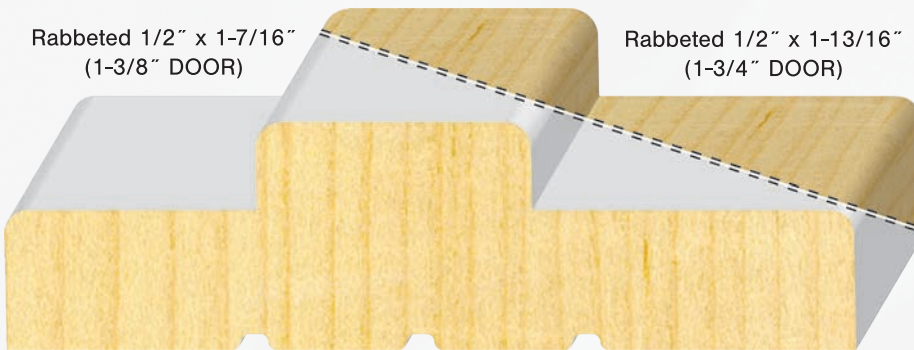

Accepts 1-3/8" Doors **OR** 1-3/4" Doors

EXTERIOR DOUBLE RABBITED FJ FRAMES

| | | Raw or Primed FJ Pine | | |
|-----|-------|-----------------------|----------|--------------------|
| | SIZE | 6/8 | 8/0 | 17' LINEAL |
| N/S | 4-5/8 | 458DR6 PR458DR6 | — | 458DRL PR458DRL |
| N/S | 5-1/4 | 514DR6 PR514DR6 | — | 514DRL PR514DRL |
| N/S | 6-5/8 | 658DR6 PR658DR6 | PR658DR8 | 658DRL PR658DRL |
| N/S | 7-1/4 | PR714DR6 | PR714DR8 | PR714DRL |



(items are approximate scale only)

Standard Exterior Door Frames

lengths available: all 6' thru 16'

| EXTERIOR DOOR FRAMES | | | | | | | |
|--|-------------|-------|-------|------------|----------|----------|------------|
| Standard for 1/2" x 1-13/16" Door Rab't. | | | | | | | |
| | Unprimed FJ | | | Primed FJ | | | |
| | SIZE | 6/8 | 8/0 | 17' LINEAL | 6/8 | 8/0 | 17' LINEAL |
| N/S | 4-1/8 | 4186 | 4188 | 418L | PR4186 | PR4188 | PR418L |
| S | 4-1/2 | 4126 | 4128 | 412L | PR4126 | PR4128 | PR412L |
| S | 4-5/8 | 4586 | 4588 | 458L | PR4586 N | PR4588 N | PR458L N |
| S | 4-3/4 | 434E6 | 434E8 | 434EL | PR434E6 | PR434E8 | PR434EL |
| N/S | 5-1/4 | 514E6 | 514E8 | 514EL | PR514E6 | PR514E8 | PR514EL |
| S | 6-1/8 | 6186 | 6188 | 618L | PR6186 | PR6188 | PR618L |
| N/S | 6-5/8 | 6586 | 6588 | 658L | PR6586 | PR6588 | PR658L |
| N/S | 7-1/4 | 714E6 | 714E8 | 714EL | PR714E6 | PR714E8 | PR714EL |

Rabbeted 1/2" x 1-13/16"
(1-3/4" DOOR)



Exterior Door Frame Specs

- ☞ 1-1/4" Thick
- ☞ 6/8 = 82-1/2" Below Dado
- ☞ 8/0 = 98-1/2" Below Dado
- ☞ No Screen Rabbet
- ☞ Single End Dado (Except on Lineal)
- ☞ 3 Pair Per Bundle
- ☞ Kerfing for Bullnose is Available
- ☞ Custom Widths Available
- ☞ FR in part no. denotes 20 Minute Fire Rating

Rabbeted 1/2" x 2-1/8"
(1-3/4" DOOR)



Weatherstrip Kerfed Exterior Door Frames

lengths available: all 6' thru 16'

| EXTERIOR DOOR FRAMES | | | | | | | | | |
|---|-------|--------------|--------------|--------------|---------------------|---------------------|----------------|-------------|----------|
| Weatherstrip Kerfed with 1/2" x 2-1/8" Rab't. | | | | | | | | | |
| | | Unprimed FJ | | | Primed FJ | | | Frame Saver | |
| | SIZE | 6/8 | 8/0 | 17' LINEAL | 6/8 | 8/0 | 17' LINEAL | 6/8 | 8/0 |
| N/S | 4-1/8 | 418W6 N/A | 418W8 N/A | 418WL N/A | PR418W6 PR418W6D | PR418W8 PR418W8D | PR418WL N/A | - | - |
| N/S | ☹ | N/A | N/A | N/A | FRPR418W6 | FRPR418W8 | N/A | | |
| S | 4-1/2 | 412W6 | 412W8 | 412WL | N/A | N/A | N/A | FS4916W6 | FS4916W8 |
| N/S | 4-5/8 | 458W6 | 458W8 | 458WL | PR458W6 PR458W6D | PR458W8 PR458W8D | PR458WL | - | - |
| N/S | ☹ | FR458WS N | FR458W8S N | N/A | FRPR458W6 | FRPR458W8 | N/A | - | - |
| S | 4-3/4 | 434W6 | 434W8 | 434WL | PR434W6 | PR434W8 | PR434WL | FS4916W6 | FS4916W8 |
| N/S | 5-1/4 | 514EW6 | 514W8 | 514WL | PR514W6 PR514W6D | PR514W8 PR514W8D | PR514WL | FS514W6 | FS514W8 |
| N/S | ☹ | N/A | N/A | N/A | FRPR514WS | FRPR514W8S | N/A | - | - |
| S | 5-1/2 | 512W6 | 512W8 | N/A | N/A | N/A | N/A | - | - |
| S | 6-1/8 | 618W6 | 618W8 | 618WL | PR618W6 | PR618W8 | PR618WL | - | - |
| N | 6-5/8 | 658W6 | 658W8 | 658WL | PR658W6 PR658W6D | PR658W8 PR658W8D | PR658WL | FS6916W6 | FS6916W8 |
| N/S | 7-1/4 | 714EW6 | 714W8 | 714WL | PR714W6 | PR714W8 | PR714WL | FS714W6 | FS714W8 |
| N/S | ☹ | FR714WS N | N/A | N/A | FRPR714WS | FRPR714W8S | N/A | - | - |
| S | 7-1/2 | 712W6 | 712W8 | 712WL | N/A | N/A | N/A | - | - |

Exterior Door Frame Specs

- ☞ 1-1/4" Thick
- ☞ 6/8 = 82-1/2" Below Dado
- ☞ 8/0 = 98-1/2" Below Dado
- ☞ No Screen Rabbet
- ☞ Single End Dado (Except on Lineal)
- ☞ 3 Pair Per Bundle
- ☞ Kerfing for Bullnose is Available
- ☞ Custom Widths Available
- ☞ FR in Part No. denotes 20 Minute Fire Rating
- ☞ 'D' at the end of part number denotes "Made in America"



Frame Saver
Primed FJ Door Frames with 4" rot proof wood composite on the bottom of each leg to prevent water absorption. (see p.351)

Interior Door Jambs

(items are approximate scale only)

lengths available: all 6" thru 16"



Kerfing for bullnose is available on all jamb sizes and species and custom size odd wall widths available upon request.

| INTERIOR DOOR JAMBS | | | | |
|----------------------------|--------|--------------------------|--------------------------|----------------------|
| Raw or Primed (PR) FJ Pine | | | | |
| | SIZE | 6/8 | 8/0 | 17' LINEAL |
| N/S | 3-9/16 | 391616 PR391616 | 391618 PR391618 | 39161L PR39161L S |
| N/S | 3-9/16 | 391616K2S PR391616K2S | 391618K2S PR391618K2S | - - |
| N/S | 4-9/16 | 491616 PR491616 | 491618 PR491618 | 49161L PR49161L |
| N/S | 4-3/4 | 43416 PR43416 | 43418 PR43418 | 4341L PR4341L |
| S | 4-7/8 | 47816 | 47818 | 4781L |
| N/S | 5-1/4 | 51416 PR51416 | 51418 PR51418 | 5141L PR5141L |
| S | 5-1/2 | 51216 | 51218 | - |
| N/S | 6-9/16 | 691616 PR691616 | 691618 PR691618 | 69161L PR69161L |
| N/S | 7-1/4 | 71416 PR71416 | 71418 PR71418 | 7141L PR7141L |
| S | 7-1/2 | 71216 | 71218 | - |
| N/S | 11-1/4 | 111416 | 111418 | - |

Interior Door Jamb Specs

NOR CAL, CENTRAL CAL, AZ

- ☞ 11/16" Thick
- ☞ 6/8 = 81" Below Dado
- ☞ 8/0 = 97" Below Dado
- ☞ Lineal - 17' = MDF, FJ Pine & Oak Veneer
- ☞ Random Lengths only available in most Solid Wood Species
- ☞ Dado depth is 3/8"
- ☞ Heads cut 3/4 over opening
- ☞ 5 pair per bundle

SO CAL, NV

- ☞ 11/16" Thick
- ☞ 6/8 = 80-5/8" Below Dado
- ☞ 8/0 = 96-5/8" Below Dado
- ☞ Lineal - 17' = MDF, FJ Pine & Oak Veneer
- ☞ Random Lengths only available in most Solid Wood Species
- ☞ Dado depth is 3/8"
- ☞ Heads cut 3/4 over opening
- ☞ 5 pair per bundle

| PRIMED DOMESTIC INTERIOR DOOR JAMBS | | | | |
|-------------------------------------|--------|-----------|-----------|------------|
| Raw FJ Pine - 1-1/4" THICK | | | | |
| | SIZE | 6/8 | 8/0 | 17' LINEAL |
| N/S | 3-9/16 | PR391616D | PR391618D | - |
| N/S | 4-9/16 | PR491616D | PR491618D | - |
| N/S | 4-3/4 | PR43416D | PR43418D | - |
| N/S | 5-1/4 | PR51416D | PR51418D | - |
| N/S | 6-9/16 | PR691616D | PR691618D | - |
| N/S | 7-1/4 | PR71416D | PR71418D | - |

| SAN DIEGO S4S (NO RAB'T) | | | | |
|----------------------------|-------|--------|--------|------------|
| Raw FJ Pine - 1-1/4" THICK | | | | |
| | SIZE | 6/8 | 8/0 | 17' LINEAL |
| N/S | 4-1/8 | 418SD6 | 418SD8 | 418SDL |
| N/S | 4-1/2 | 412SD6 | 412SD8 | 412SDL |
| N/S | 4-3/4 | 434SD6 | 434SD8 | 434SDL |
| N/S | 5-1/4 | 514SD6 | 514SD8 | 514SDL |
| N/S | 6-1/8 | 618SD6 | 618SD8 | 618SDL |
| N/S | 7-1/4 | 714SD6 | 714SD8 | 714SDL |

1-1/4" THICK JAMBS
(NO RAB'T)



Big Ideas

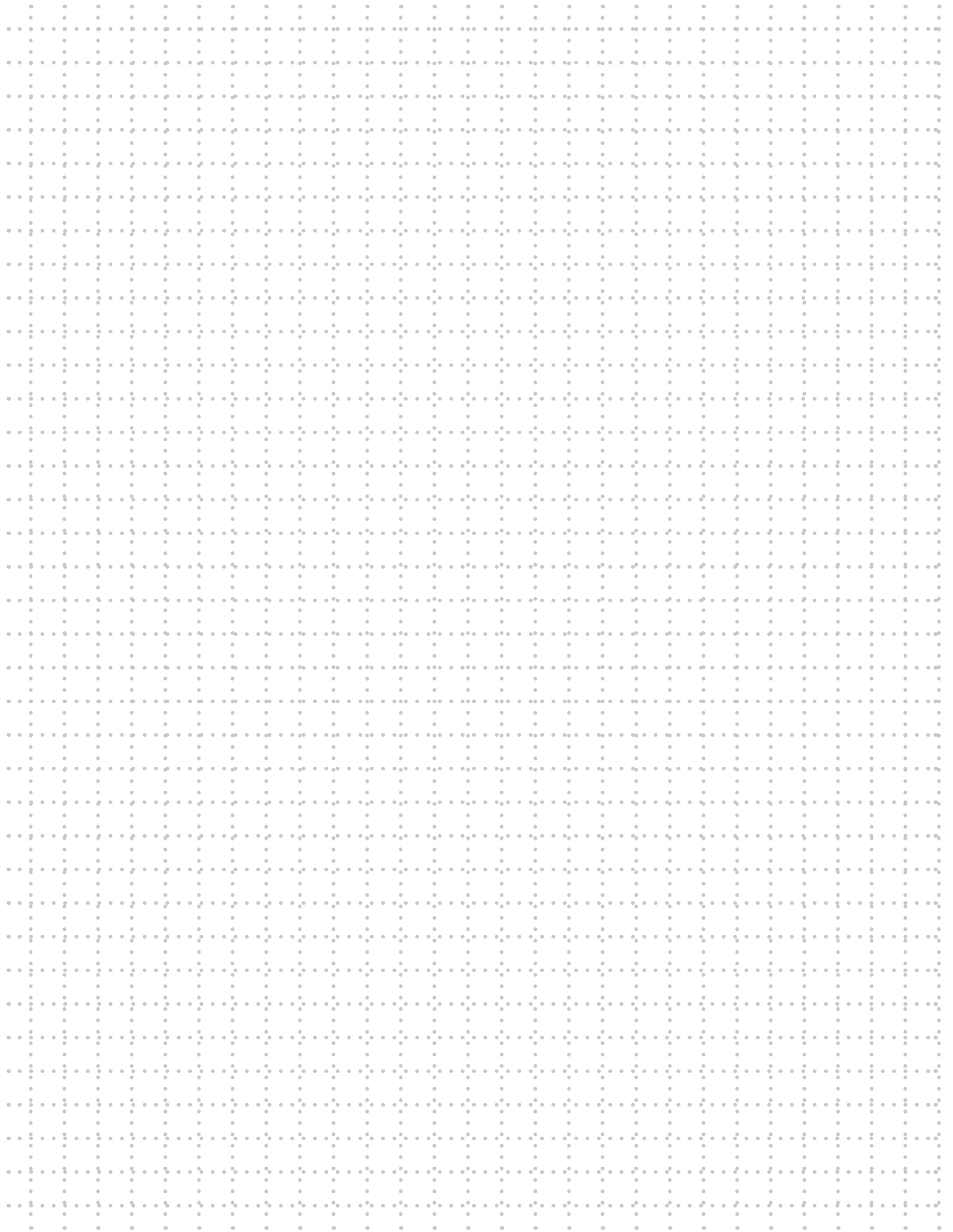

Big Ideas



Ultralight (MUL) & Light Density (LDF) MDF



FOR PAINTGRADE ARCHITECTURAL MILLWORK



With costs less than Finger Joint Pine, Ultralight (MUL) and Light Density (LDF) MDF are pre-primed, have no joints, will not crack, split, twist or warp and never have raised or inconsistent grain. MUL and LDF are available in long lengths with no trimbacks. MDF has become the moulding of choice, for multi-million dollar homes, entry to high-end tract housing and commercial spaces, to create unique spaces while reducing millwork costs.

section contents

| | |
|------------------------------------|-----|
| Base | 201 |
| Casing..... | 185 |
| Crown Mold..... | 226 |
| Chair Rail..... | 249 |
| Cleat..... | 252 |
| Door Stop..... | 200 |
| Flat Astragal/Panel Mold..... | 250 |
| Header | 200 |
| Hook..... | 252 |
| Interior Door Jambs | 255 |
| MDF Shelving | 254 |
| Panel Cap..... | 250 |
| Pediment Crown..... | 225 |
| S4S..... | 253 |
| Wainscotting & Wainscot Base | 251 |
| Wall Cap | 253 |
| Window Stool..... | 252 |

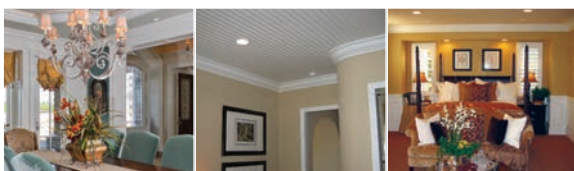

Ultralight & LDF MDF

I

DESIGN STYLES

**JANKA
HARDNESS**
(POUNDS-FORCE)

1000-1500

CUT LIST

TRADITIONAL | COASTAL | CONTEMPORARY | COUNTRY FRENCH

Determining How Much You Need

- 1 Measure the room at the height or length where each moulding goes to determine the number and the length of the pieces you'll need.
- 2 MDF casing and stop is available in 7' on select profiles, 17' on all casing profiles and 16' or 17' on door stop. When figuring how much footage your project requires, for each type of moulding, base, casing, crown, etc., measure your walls or openings and add the footage. Then multiply the footage by 1.1. The result is the total footage needed plus 10% for waste.
- 3 When ordering casing for 6/8 doors: Jamb that are 80-5/8" BD use 7' casing on profiles 3" wide or smaller. Use 17' casing for profiles wider than 3" or for 8/0 doors. Jamb that are 81" BD use 7' casing on profiles 2-1/4" or smaller and 17' casing for profiles wider than 2-1/4" or for 8/0 doors.
- 4 Most door heads are cut from 7' legs (2- 3/0 heads or ONE door opening). Always cut the longest pieces first: door legs, window legs, long window heads and sills, and then door heads.
- 5 The most important tool when working with moulding is **patience**. Remember the old adage, measure twice and cut once. Never try to rush trim work.
- 6 Lengths ordered may not always be available. Always verify availability when ordering.

ALWAYS TEST TO MAKE SURE YOUR MEASURING TOOLS ARE ACCURATE. IF YOU ARE WORKING WITH A HELPER, TAKE A MEASUREMENT WITH ONE TOOL WHILE YOUR HELPER MEASURES WITH ANOTHER AND COMPARE YOUR RESULTS.

FINISHING

1 Fill nail holes with your choice of nail filler, patch or putty; experiment for best results.

2 Sand lightly and vacuum dusty film.

3 Caulk miters, door stops and all gaps even if the casing is tight to the jamb. NOTE: MDF will shrink as much as 1/4" if proper acclimation did not occur. You may experience shrinkage if the hole is not fully filled. Pushing the putty twice firmly in the hole with help prevent shrinkage as the putty dries out.

4 Factory primed mouldings permit the use of both water-based and solvent-based finish coat applications. Avoid using any catalyzed paints or varnishes. A second prime coat or scuff sanding is optional. Apply the finish coats with brush, roller or spray using flat, semi-gloss, enamel or lacquer; whatever suits your requirements.

HELPFUL HINTS

- ❖ **Miter all inside corners** for baseboard, chair rail, and crown molding.
- ❖ **Glue all miters and splices**—both sides/pieces of each joint, to control moisture content and to prevent stain from wicking into the endgrain and darkening the miters joints.
- ❖ **Pre-assemble wide casing using miter clamps.** Without clamping pressure, glue joints will not reach the full strength of the glue.
- ❖ **CHECK the moisture content of all wood moulding:** for interior trim, the MC should be 8-10%; for exterior trim the MC should be 12-14%. For every 4% change in MC, wood moves 1%.
- ❖ **For painted trim:** caulk over any nails that are overdriven—countersunk too deep.
- ❖ **Last mouldings to be installed:** base, shoe and quarter rounds.
- ❖ **Chair rails** can be installed 32" to 36" from the floor.
- ❖ Use Rosettes and Plinth blocks at the corners of windows and doors to **eliminate the mitering process.**
- ❖ **After installation is complete:** caulk and/or putty all gaps and nail holes.
- ❖ Use any brand of spray furniture polish on saw blade as a **lubricant for easier cutting.**



LIKE ALL WOOD PRODUCTS, MDF ABSORBS AND DESORBS MOISTURE WITH CHANGES IN RELATIVE HUMIDITY. THE NORMAL RANGE OF INTERIOR HUMIDITY IS 40 TO 80%. INDUSTRY STANDARD FOR MAXIMUM EXPANSION AND CONTRACTION OF MDF DUE TO CHANGES IN RELATIVE HUMIDITY FROM 40% TO 85% IS .3%. THUS, SOME EXPANSION AND CONTRACTION OF MDF MOULDINGS MAY OCCUR.

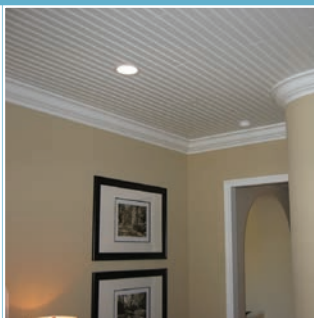

(items are approximate scale only)

1-1/4" to 2-1/4" Casing

lengths available: 7' & 17'



970LDF 11/16 x 1-1/4
LDF 2EE Door Header Fillet N/S



102MUL 9/16 x 1-9/16
Ultralight Beveled/Streamline Casing N/S



107MUL 9/16 x 1-5/8
Ultralight #711 Casing N/S



130MUL 5/8 x 1-5/8
Ultralight Moulded Casing N/S



121MUL 9/16 x 2
Ultralight Clamshell Casing S
(PRE-MITERED AVAILABLE) M



103MUL 9/16 x 2-1/4
Ultralight Beveled/Streamline Casing N/S

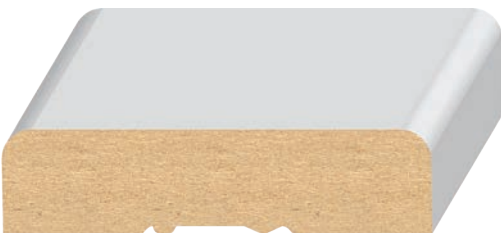

120MUL 5/8 x 2-1/4
Ultralight 2 Round Edge Casing N/S



146MUL-2 11/16 x 2-1/4
Ultralight Classic Beaded Casing N/S



2-1/4" Casing

(items are approximate scale only)

✦ lengths available: 7' & 17'



149MUL-2 11/16 x 2-1/4
Ultralight Meridian Casing N/S



152MUL 5/8 x 2-1/4 **Ultralight Colonial/#356 Casing** N/S
152BMUL 11/16 x 2-1/4 **Ultralight Colonial/#356 Casing** N/S
 (PRE-MITERED AVAILABLE) (M)

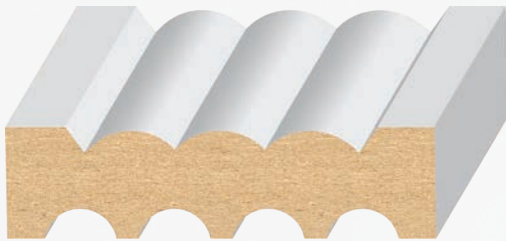

158MUL-2 9/16 x 2-1/4
Ultralight 4-Flute & Reed Casing N/S
 (Reversible)

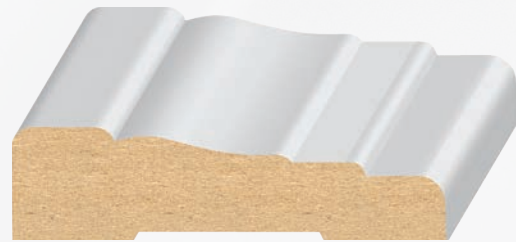

162MUL-2 5/8 x 2-1/4
Ultralight #366 Casing S
 [FORMERLY 162MUL]



172MUL-2 11/16 x 2-1/4 **Ultralight Contemporary Casing** N/S

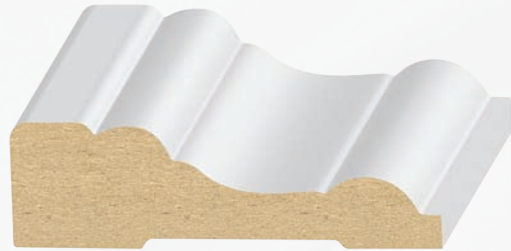

194MUL 11/16 x 2-1/4
Ultralight Tucson Casing S
 [FORMERLY 104MUL]



195MUL 9/16 x 2-1/4
Ultralight Clamshell Casing S
 [FORMERLY 105MUL]



196MUL 9/16 x 2-1/4
Ultralight Peoria Casing S
 [FORMERLY 106MUL]



(items are approximate scale only)

2-7/16" to 2-1/2" Casing

lengths available: 7' & 17'

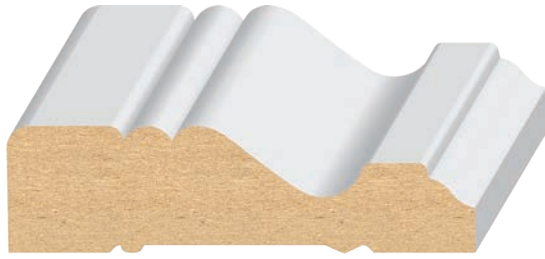

132MUL 11/16 x 2-7/16
Ultralight Carolina/Palisade Casing N/S



167MUL 11/16 x 2-7/16
Ultralight Santa Fe/#275 Casing N/S

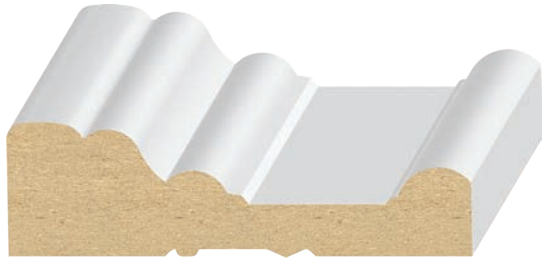

178MUL 11/16 x 2-7/16
Ultralight Howe Casing N/S



108MUL 5/8 x 2-1/2
Ultralight #711 Casing N/S
(PRE-MITERED AVAILABLE) 



110MUL 5/8 x 2-1/2
Ultralight 3-Step Casing N/S

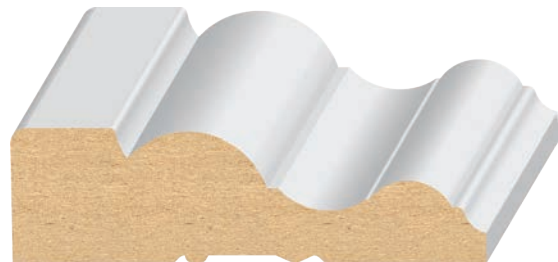

128MUL 11/16 x 2-1/2
Ultralight Mission/Bel-Air Casing N/S



131MUL 5/8 x 2-1/2 **Ultralight Riviera Casing** N/S

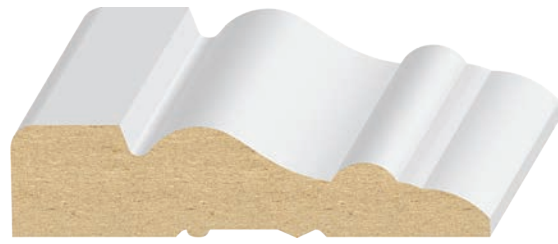

134MUL 5/8 x 2-1/2
Ultralight Bay Shore/Bayport Casing N/S

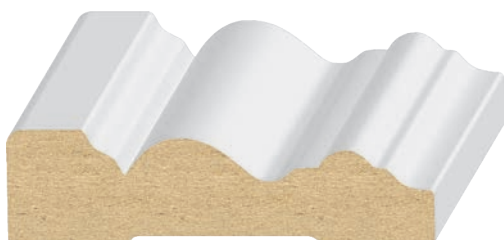

135MUL-2 9/16 x 2-1/2
Ultralight Monterey/Colorado Casing N/S
[FORMERLY 123MUL]



137MUL 5/8 x 2-1/2
Ultralight Carmel Casing N/S



2-1/2" Casing

(items are approximate scale only)

✂ lengths available: 7' & 17'

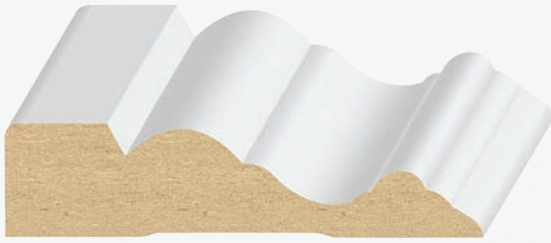

138MUL 5/8 x 2-1/2
Ultralight Mackenzie Casing N/S



150MUL 5/8 x 2-1/2 **Ultralight Cape Cod Casing** N/S



157MUL 1-3/16 x 2-1/2 **Ultralight Bel-Air/Coronado Casing** N/S



159MUL 1 x 2-1/2 **Ultralight Lancaster/Hermosa Casing** N/S



164MUL 1-3/16 x 2-1/2 **Ultralight Bel Court Casing** S



169MUL 11/16 x 2-1/2 **Ultralight Victorian/Tudor Casing** N/S



197MUL 11/16 x 2-1/2 **Ultralight S4S Notched Modern Casing** N/S



198MUL 11/16 x 2-1/2 **Ultralight Ogee Casing** N/S



(items are approximate scale only)

2-9/16" to 3" Casing

lengths available: 7' & 17'

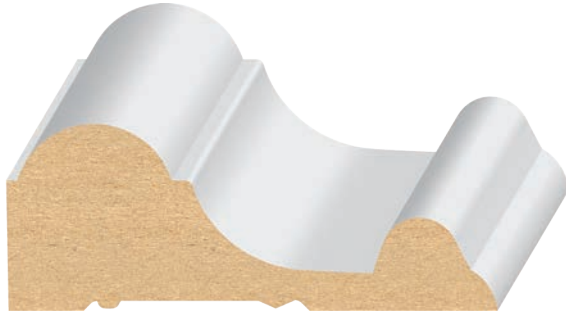

181MUL 1 x 2-9/16 **Ultralight Malibu Casing** S

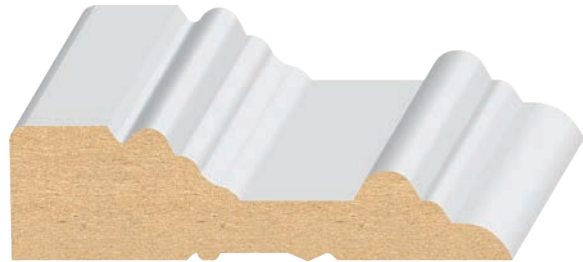

168MUL 3/4 x 2-5/8 **Ultralight Santa Clara/Crescent Casing** N/S



119MUL 11/16 x 2-7/8 **Ultralight Solano/Colonial Casing** N/S

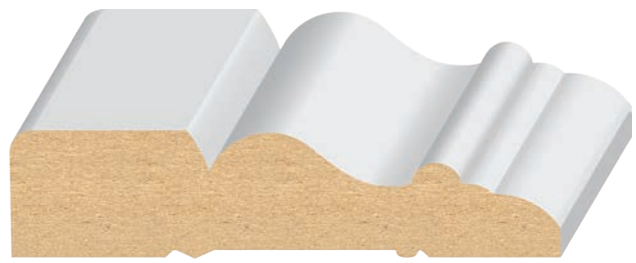

125MUL 11/16 x 2-7/8 **Ultralight Victorian/Newport Casing** N/S

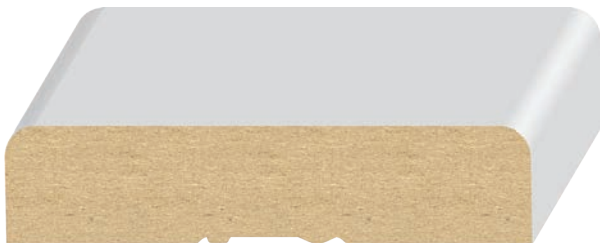

122MUL 3/4 x 2-3/4 **Ultralight 2 Round Edge Casing** N/S
122MUL-SC 9/16 x 2-3/4 **Ultralight Scant 2 Round Edge Casing** N/S



127MUL 5/8 x 3 **Ultralight Del Mar/New Hampshire Casing** N/S



3" to 3-1/4" Casing

(items are approximate scale only)

✂ lengths available: 7' & 17'



165MUL 11/16 x 3 **Ultralight Santa Fe/#275 Casing** N/S



192MUL 11/16 x 3 **Ultralight Intrada Casing** N/S



129MUL 3/4 x 3-1/4 **Ultralight Mission/Bel-Air Casing** N/S



133MUL 11/16 x 3-1/4 **Ultralight Carolina/Palisade Casing** N/S



135MUL-3 11/16 x 3-1/4 **Ultralight Monterey/Colorado Casing** N/S

[FORMERLY 135MUL]

135MUL-3SC 11/16 x 3 **Ultralight Colorado Casing** S

[FORMERLY 124MUL]



(items are approximate scale only)

3-1/4" Casing

lengths available: 7' & 17'



139MUL 11/16 x 3-1/4 **Ultralight 2 Round Edge Casing** N/S
139MUL-SC 9/16 x 3-1/4 **Ultralight Scant 2 Round Edge Casing** N/S

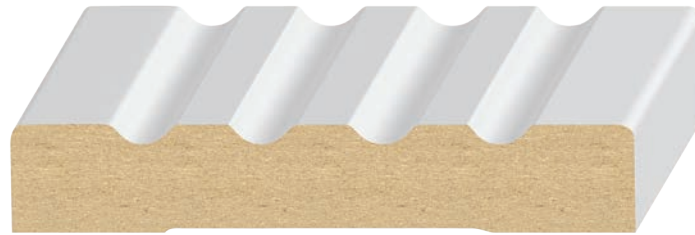

154MUL 9/16 x 3-1/4 **Ultralight 4-Flute Casing** S
(NOT REVERSIBLE)
[FORMERLY 109MUL]

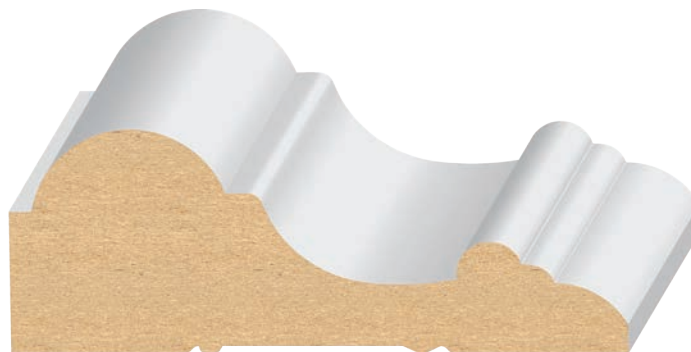

160MUL 1-3/16 x 3-1/4 **Ultralight Lancaster/Hermosa Casing** N/S



161MUL 11/16 x 3-1/4 **Ultralight Cambridge Casing** S

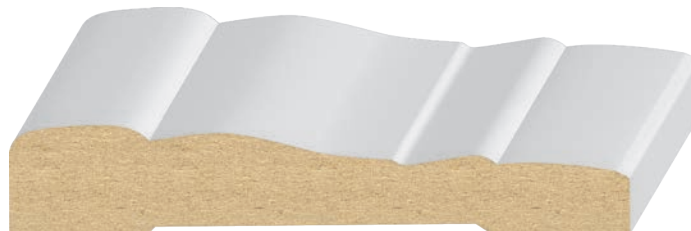

162MUL-3 5/8 x 3-1/4 **Ultralight #366 Casing** S **NEW**
[FORMERLY 163MUL]



3-1/4" Casing

(items are approximate scale only)

lengths available: 7' & 17'



170MUL 1 x 3-1/4 **Ultralight Victorian/Tudor Casing** N/S



176MUL 11/16 x 3-1/4 **Ultralight Moulded Colonial/#356 Casing** N/S

176MUL-SC 9/16 x 3-1/4 **Ultralight Scant #356 Casing** S



184MUL 5/8 x 3-1/4 **Ultralight Carmel Casing** N/S



186MUL 1 x 3-1/4 **Ultralight 49er Casing** N/S



(items are approximate scale only)

3-1/4" to 3-7/16" Casing

lengths available: 7' & 17'



191MUL 15/16 x 3-1/4 **Ultralight Chandler Casing** S

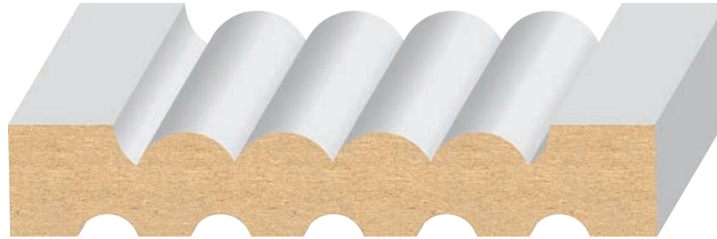

158MUL-3 9/16 x 3-3/8 **Ultralight (Reversible) 5-Flute & Reed Casing** N/S



180MUL 1-3/16 x 3-3/8 **Ultralight Malibu Casing** N/S



146MUL-3 7/8 x 3-7/16 **Ultralight Classic Beaded Casing** N/S



149MUL-3 7/8 x 3-7/16 **Ultralight Meridian Casing** N/S

3-1/2" Casing

(items are approximate scale only)

✦ lengths available: 7' & 17'

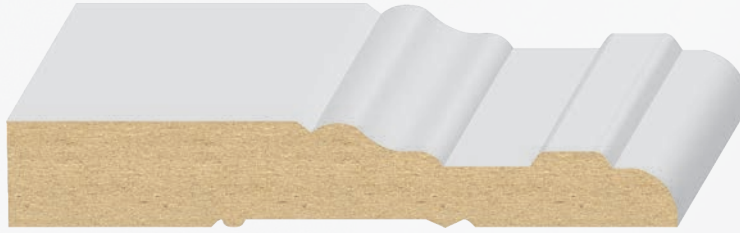

118MUL-3 9/16 x 3-1/2 **Ultralight Colonial Base/Casing** s



126MUL 1 x 3-1/2 **Ultralight Belmont/Crescent Casing** N/S

126MUL-SC 11/16 x 3-1/2 **Ultralight Scant Crescent Casing** s



147MUL 1-3/16 x 3-1/2 **Ultralight Savannah Casing** s



155MUL 11/16 x 3-1/2 **Ultralight Cape Cod Casing** N/S



156MUL 7/8 x 3-1/2 **Ultralight Shasta Casing** N/S

(items are approximate scale only)

3-1/2" Casing

lengths available: 7' & 17'



166MUL 1 x 3-1/2 **Ultralight Santa Fe/#275 Casing** N/S



172MUL-3 11/16 x 3-1/2 **Ultralight Contemporary Casing** N/S

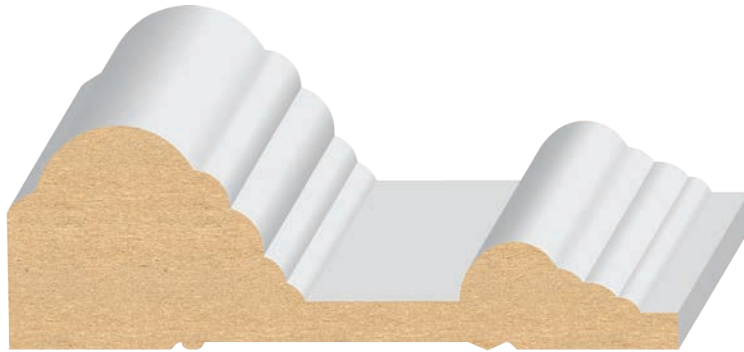

173MUL 1-3/16 x 3-1/2 **Ultralight Crescent Casing** S



177MUL 1 x 3-1/2 **Ultralight Howe Casing** N/S

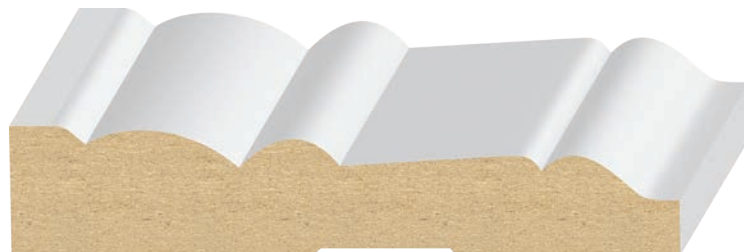

179MUL 11/16 x 3-1/2 **Ultralight Shasta Casing** N/S



3-1/2" to 4-1/8" Casing

(items are approximate scale only)

✂ lengths available: 7' & 17'



189MUL 1-3/16 x 3-1/2 **Ultralight Bel-Air Casing** N/S



183MUL 11/16 x 3-9/16 **Ultralight Georgian Casing** N/S

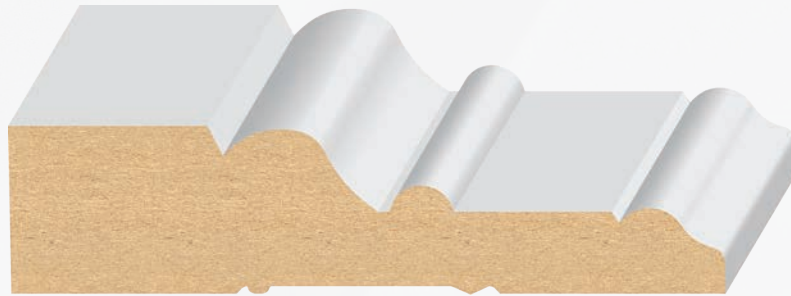

175MUL 7/8 x 3-3/4 **Ultralight Sierra/Tuscany Casing** N/S



193MUL 11/16 x 4 **Ultralight Bullhead Casing** S



174MUL 1-1/8 x 4-1/8 **Ultralight Howe Casing** N/S

(items are approximate scale only)

4-1/4" Casing

lengths available: 7' & 17'



118MUL-4 9/16 x 4-1/4 **Ultralight Colonial Base/Casing** **S**

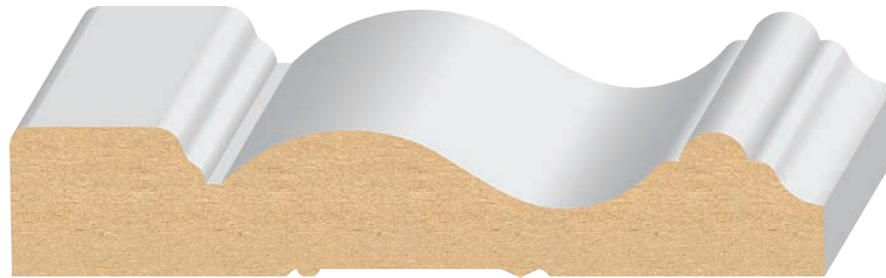

136MUL 13/16 x 4-1/4 **Ultralight Monterey/Colorado Casing** **N/S**

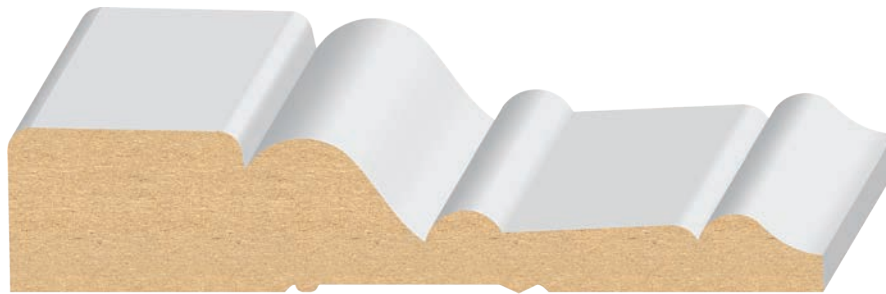

140MUL 7/8 x 4-1/4 **Ultralight Tuscany Casing** **N/S**



143MUL 1-3/16 x 4-1/4 **Ultralight Williamsburg Casing** **S**

4-1/4" Casing

(items are approximate scale only)

✂ lengths available: 7' & 17'



146MUL-4 7/8 x 4-1/4 **Ultralight Classic Beaded Casing** N/S



148MUL 1-3/16 x 4-1/4 **Ultralight Malibu Casing** S



149MUL-4 7/8 x 4-1/4 **Ultralight Meridian Casing** N/S

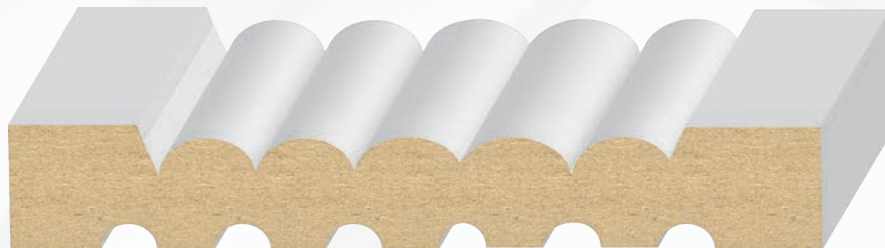

158MUL-4 11/16 x 4-1/4 **Ultralight (Reversible) 6-Flute & Reed Casing** N/S

(items are approximate scale only)

4-1/4" to 4-1/2" Casing

lengths available: 7' & 17'



185MUL 1-3/16 x 4-1/4 **UltraLight Carolina Casing** N/S



145MUL 3/4 x 4-1/2 **UltraLight 2 Round Edge Craftsman Casing** N/S

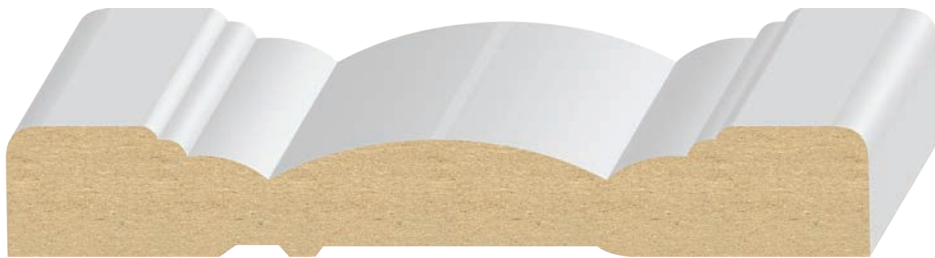

187MUL 11/16 x 4-1/2 **UltraLight Boulder Casing** N/S



190MUL 1-3/16 x 4-1/2 **UltraLight Belvedere/Sedona Casing** N/S

Header

(items are approximate scale only)

lengths available: 16'



998MUL 1 x 4-1/2 **Ultralight Lintel Mold** N/S
[Used for Door Headers]



158MUL-5 9/16 x 5-1/2 **Ultralight (Reversible) 8-Flute & Reed Casing** S
[FORMERLY 171MUL]



144MUL 1-1/16 x 5-1/2 **Ultralight 1 Round Edge Craftsman Header** N/S

Door Stop

lengths available: 7', 8' & 17'



201MUL 7/16 x 1-1/4
Ultralight 1 Round Edge Stop N/S



202MUL 3/8 x 1-1/4
Ultralight 2 Round Edge Stop N/S

201LDF 7/16 x 1-1/4
1 Round Edge Stop N



203MUL 1/2 x 1-3/8
Ultralight 2 Round Edge Stop N/S



204MUL 7/16 x 1-1/4
Ultralight 2 Round Edge Stop N/S



210MUL 1/2 x 1-3/4
Ultralight Colonial/Ogee Stop N/S

2-1/4" to 3-1/4" Base

lengths available: 7' & 17'

(items are approximate scale only)



304MUL 3/8 x 2-1/4
Ultralight Streamline Base N/S

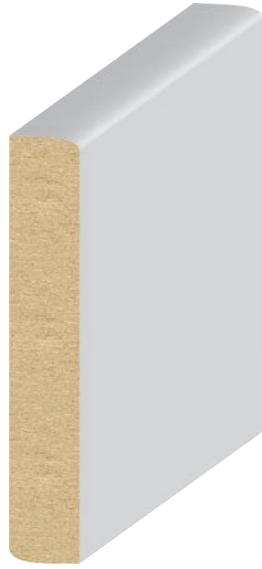

R304MUL-2 3/8 x 2-1/4
Ultralight Reversible Base N/S



310MUL 3/8 x 2-1/2
Ultralight #711 Base N/S

310BMUL 7/16 x 2-1/2
Ultralight #711 Base S



319MUL 1/2 x 2-1/2
Ultralight #356 Base S



311LDF-3N 1/2 x 3
Ultralight #711 Base S
 [FORMERLY 311LDF-3]



314MUL-3 9/16 x 3-1/4
Ultralight Coronado/#623 Base N/S

314MUL-3SC 1/2 x 3-1/4
Ultralight Coronado/#623 Base N/S



320MUL 1/2 x 3-1/4
Ultralight Colonial/#356 Base N/S

3-1/4" to 3-1/2" Base

lengths available: 7' & 17'

(items are approximate scale only)



351MUL 9/16 x 3-1/4
Ultralight Sierra Base N/S



361MUL-3 9/16 x 3-1/4
Ultralight Monterey/Sonoma Base N/S



366MUL 9/16 x 3-1/4
Ultralight #366 Base S



735MUL 1/2 x 3-1/4 (w/ 3/8" Rab't)
Ultralight Wainscot Base N/S

736MUL 1/2 x 5 (w/ 3/8" Rab't)
Ultralight Wainscot Base N/S



118MUL-3 9/16 x 3-1/2
Ultralight Colonial Base/Casing S



307MUL 9/16 x 3-1/2
Ultralight Bullnose Base N/S



3-1/2" to 3-3/4" Base

lengths available: 16'

(items are approximate scale only)



311MUL 3/8 x 3-1/2 **Ultralight #711 Base** N/S
311BMUL 7/16 x 3-1/2 **Ultralight #711 Base** S



321MUL-3 1/2 x 3-1/2
Ultralight 3-Step Base N/S
 [FORMERLY 322MUL]



335MUL 7/16 x 3-1/2
Ultralight Monterey Base S



338MUL-3 9/16 x 3-7/16
**Ultralight Santa Fe/
 #175 Base** N/S
 [FORMERLY 325MUL-3]



339MUL 9/16 x 3-1/2
**Ultralight Santa Clara/
 Crescent Base** N/S



387MUL-3 7/16 x 3-1/2
**Ultralight 1EE
 Craftsman Base** N/S
 [FORMERLY 388MUL-3]



324MUL 9/16 x 3-3/4
**Ultralight Mission/
 Hermosa Base** N/S



3-7/8" to 4-1/8" Base

lengths available: 16'

(items are approximate scale only)

ultralight (MUL) & light density (LDF) mdf | base



313MUL 7/16 x 3-7/8
Ultralight
Cape Cod Base S



329MUL 9/16 x 3-7/8
**Ultralight Victorian/
Newport Base** N/S



318MUL-4 9/16 x 4
Ultralight
Cape Cod Base N/S
[FORMERLY 318MUL]



321MUL-4 1/2 x 4-1/8
**Ultralight 3-Step
Base** N/S
[FORMERLY 321MUL]



(items are approximate scale only)

4-3/16" to 4-1/4" Base

lengths available: 16'



311MUL-4 7/16 x 4-3/16
#711 Base S
311LDF-4 7/16 x 4-3/16
#711 Base S



118MUL-4 9/16 x 4-1/4
Ultralight Colonial Base S
362MUL-4 9/16 x 4-1/4
Ultralight Solano Base N



314MUL-4 9/16 x 4-1/4
Ultralight Coronado/ #620 Base N/S



326MUL 9/16 x 4-1/4
Ultralight Santa Clara/ Crescent Base N/S



4-1/2" Base

lengths available: 16'

(items are approximate scale only)



325MUL 9/16 x 4-1/2
Ultralight Imperial/#175 Base N/S



327MUL-4 9/16 x 4-1/2
**Ultralight Del Mar/
New Hampshire Base** N/S
[FORMERLY 327MUL]



338MUL-4 9/16 x 4-1/2
Ultralight Santa Fe/#175 Base N/S



(items are approximate scale only)

4-1/2" Base

lengths available: 16'



349MUL-4 9/16 x 4-1/2
Ultralight Meridian Base N/S



361MUL-4 9/16 x 4-1/2
Ultralight Monterey/Sonoma Base N/S

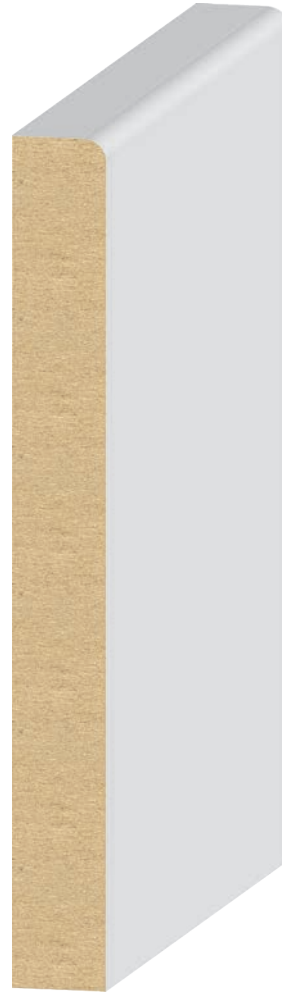

387MUL-4 1/2 x 4-1/2
Ultralight 1 Eased Edge Craftsman Base N/S
[FORMERLY 388MUL-4]



392MUL-4 9/16 x 4-1/2
Ultralight S4S Notched Modern Base N/S



5" Base

✂ lengths available: 16'

(items are approximate scale only)



323MUL 9/16 x 5
**Ultralight Mission/
Hermosa Base** N/S



330MUL 9/16 x 5
Ultralight Newport Base S
330BMUL 9/16 x 5-1/4
Ultralight Victorian/Newport Base N/S



390MUL 9/16 x 5
**Ultralight
Intrada Base** N/S



(items are approximate scale only)

5-1/4" Base

lengths available: 16'



314MUL-5 9/16 x 5-1/4
Ultralight Coronado/#618 Base N/S
[FORMERLY 315MUL]

314MUL-5SC 1/2 x 5-1/4
Ultralight Scant Coronado Base N



317MUL 9/16 x 5-1/4
Ultralight Crescent Base S



318BMUL 9/16 x 5-1/4
Ultralight "B" Cape Cod Base S



5-1/4" Base

lengths available: 16'

(items are approximate scale only)



318MUL-5 9/16 x 5-1/4
Ultralight Cape Cod Base N/S



327MUL-5 9/16 x 5-1/4
**Ultralight Del Mar/
New Hampshire Base** N/S



328MUL-5 9/16 x 5-1/4
**Ultralight Vintage/
Colonial Base** N/S
[FORMERLY 328MUL]



(items are approximate scale only)

5-1/4" Base

lengths available: 16'



338MUL-5 9/16 x 5-1/4
Ultralight
Santa Fe/#175 Base N/S
[FORMERLY 338MUL]



341MUL 9/16 x 5-1/4
Ultralight
Monterey Base S



349MUL-5 9/16 x 5-1/4
Ultralight
Meridian Base N/S



350MUL 9/16 x 5-1/4
Ultralight
Georgian Base N/S



5-1/4" Base

✂ lengths available: 16'

(items are approximate scale only)



352MUL 9/16 x 5-1/4
UltraLight Sierra Base N/S
352MUL-SC 1/2 x 5-1/4
UltraLight Scant Sierra Base N



355MUL 9/16 x 5-1/4
UltraLight Harris Base N/S



361MUL-5 9/16 x 5-1/4
**UltraLight Monterey/
Sonoma Base** N/S
[FORMERLY 361MUL]



(items are approximate scale only)

5-1/4" Base

lengths available: 16'



118MUL-5 9/16 x 5-1/4
Ultralight Colonial Base S

362MUL-5 9/16 x 5-1/4
Ultralight Solano Base N



365MUL 5/8 x 5-1/4
Ultralight Lancaster Base S



368MUL 9/16 x 5-1/4
Ultralight #566 Base S



5-1/4" to 5-1/2" Base

lengths available: 16'

(items are approximate scale only)

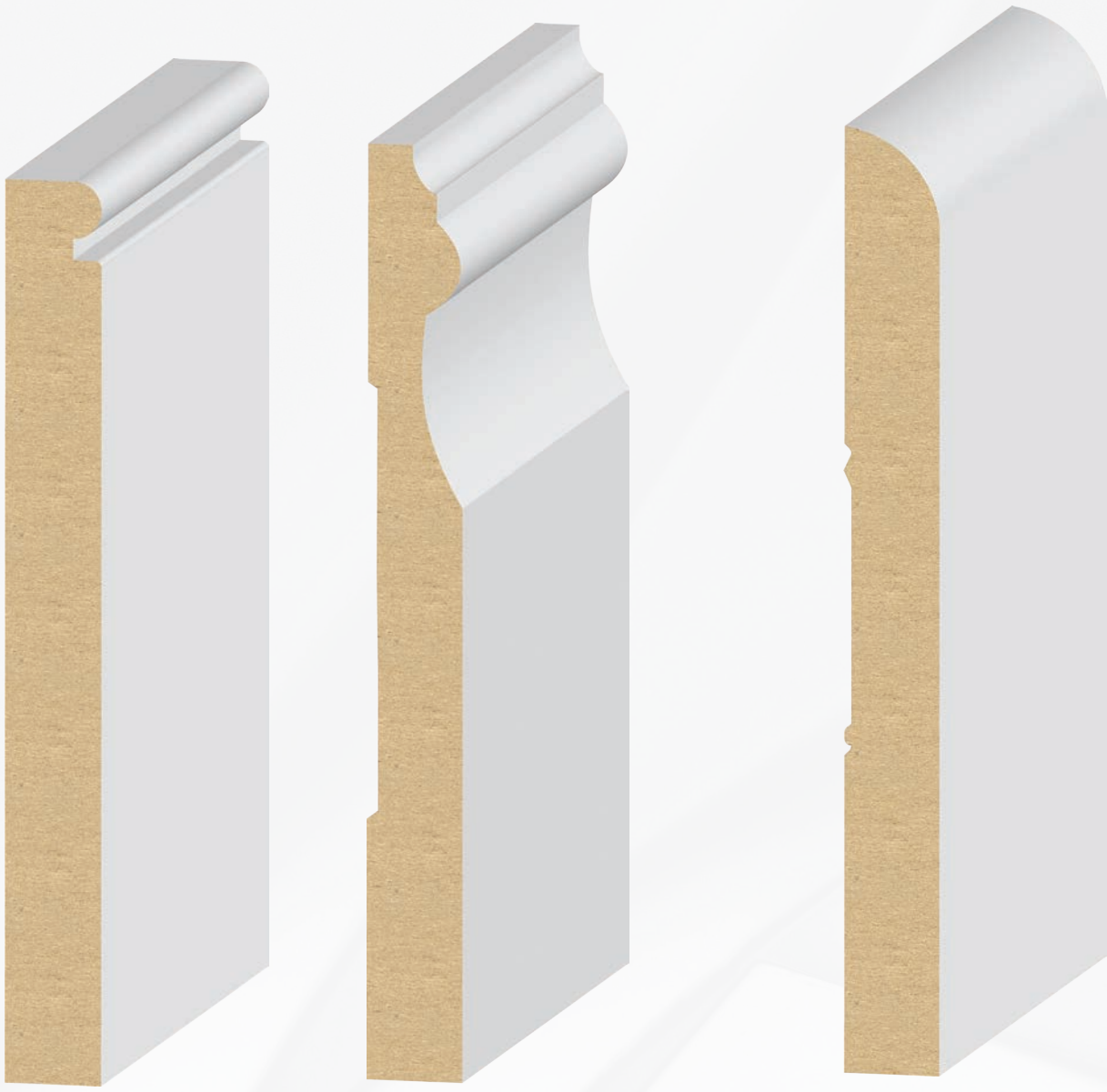

372MUL-5 1/2 x 5-1/4
Ultralight Contemporary Base N/S

359MUL 9/16 x 5-7/16
Ultralight Classic Beaded Base N/S
 [FORMERLY 377MUL]

354MUL 9/16 x 5-1/2
Ultralight Bullnose Base N/S



(items are approximate scale only)

5-1/2 to 6" Base

lengths available: 16'

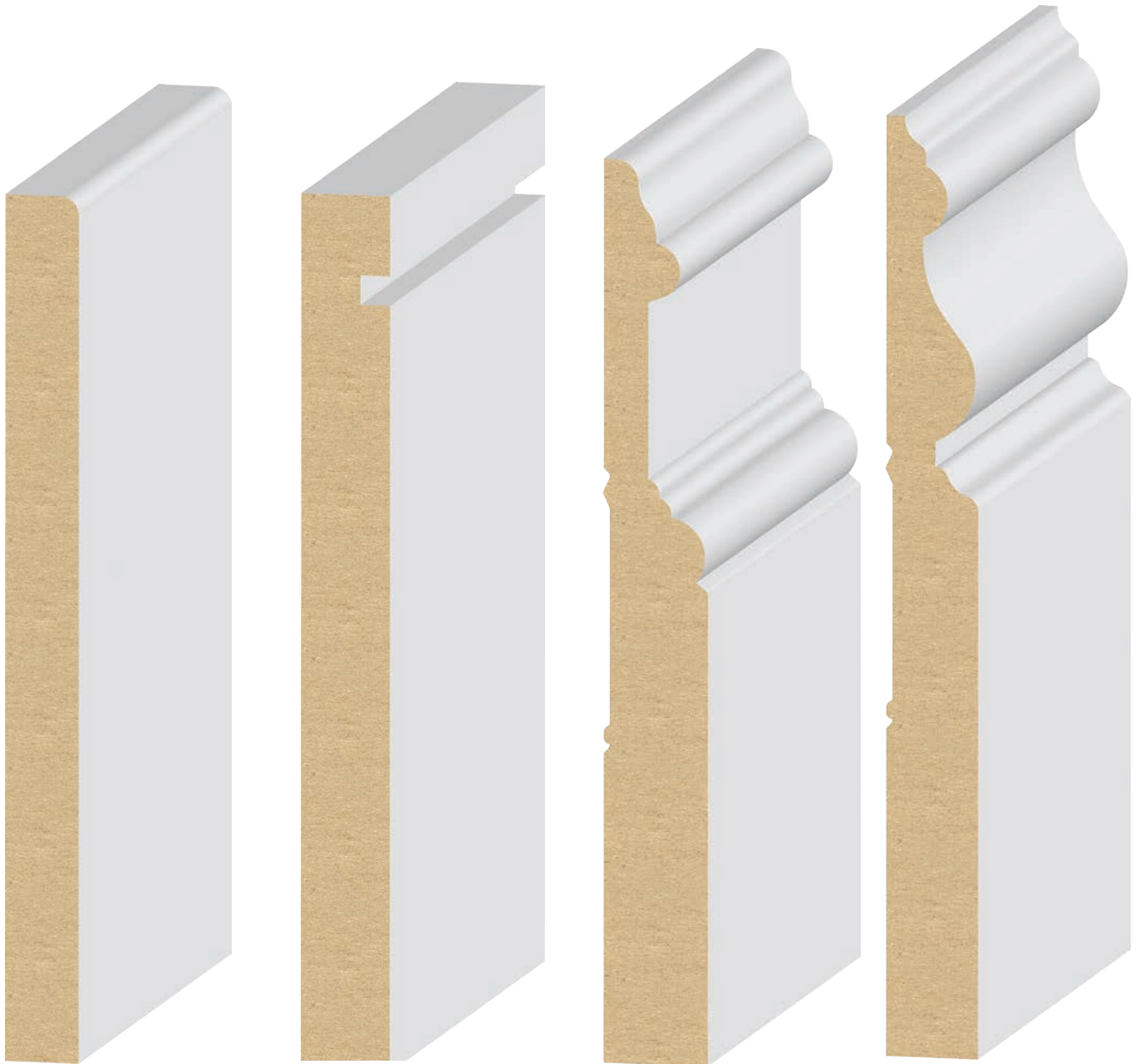

387MUL-5 1/2 x 5-1/2
**Ultralight
1 Eased Edge Base** N/S
[FORMERLY 388MUL-5]

392MUL-5 9/16 x 5-1/2
**Ultralight S4S Notched
Modern Base** N/S

332MUL 11/16 x 5-3/4
**Ultralight Santa Clara/
Crescent Base** N/S

342MUL-6 9/16 x 6
**Ultralight Imperial/
#175 Base** N/S
[FORMERLY 342MUL]



6" to 6-1/8" Base

lengths available: 16'

(items are approximate scale only)



375MUL 1 1/16 x 6
Ultralight Tuscany Base N/S



385MUL 5/8 x 6
**Ultralight Carolina/
Palisade Base** N/S



328MUL-6 9/16 x 6-1/8
**Ultralight Vintage/
Colonial Base** N/S



(items are approximate scale only)

6-1/2" to 7-1/4" Base

lengths available: 16'



334MUL 3/4 x 6-1/2
Ultralight Vermont Base S

334BMUL 9/16 x 6-1/2
**Ultralight Savannah/
Vermont Base** N/S
(THIN VERSION)



389MUL 11/16 x 6-1/2
Ultralight Plinth Base N/S



118MUL-7 9/16 x 7-1/4
Ultralight Colonial Base S

7-1/4" Base

lengths available: 16'

(items are approximate scale only)



314MUL-7 9/16 x 7-1/4
**Ultralight Coronado/
#613 Base** *N/S*



333MUL 9/16 x 7-1/4
**Ultralight Mission
Bay Base** *N/S*



340MUL 9/16 x 7-1/4
**Ultralight Malibu/
Hermosa Base** *N/S*



342MUL-7 9/16 x 7-1/4
**Ultralight Imperial/
#175 Base** *N/S*

ultralight (MUL) & light density (LDF) mdf | base



(items are approximate scale only)

7-1/4" Base

lengths available: 16'



343MUL 9/16 x 7-1/4
Ultralight Laguna Base S



345MUL 5/8 x 7-1/4
**Ultralight Santa Clara/
Crescent Base** N/S



349MUL-7 5/8 x 7-1/4
**Ultralight
Meridian Base** N/S

7-1/4" Base

✂ lengths available: 16'

(items are approximate scale only)



353MUL 9/16 x 7-1/4
UltraLight Sierra Base N/S



358MUL 9/16 x 7-1/4
UltraLight Bullnose Base N/S



360MUL 9/16 x 7-1/4
UltraLight Classic Beaded Base N/S
[FORMERLY 376MUL]



(items are approximate scale only)

7-1/4" to 7-3/8" Base

✂ lengths available: 16'



361MUL-7 9/16 x 7-1/4
**Ultralight Monterey/
Sonoma Base** N/S
[FORMERLY 386MUL]

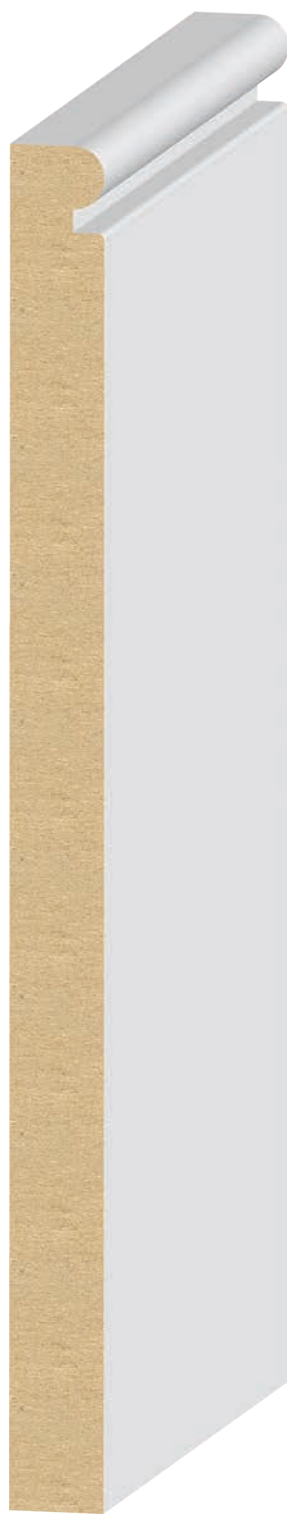

372MUL-7 1/2 x 7-1/4
**Ultralight
Contemporary
Base** N/S

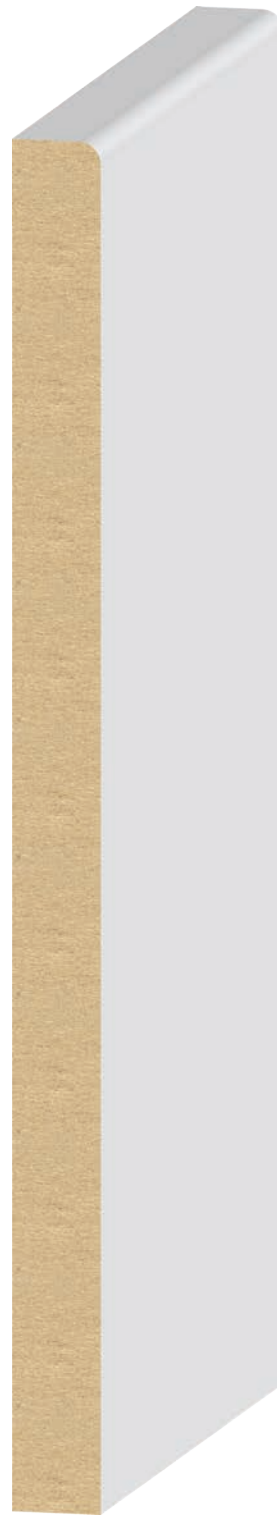

387MUL 1/2 x 7-1/4
**Ultralight
1 Eased Edge
Craftsman Base** N/S



379MUL 1 x 7-3/8
**Ultralight
Savannah Base** S

8" to 8-1/2" Base

lengths available: 16'

(items are approximate scale only)



331MUL 9/16 x 8
**Ultralight Victorian/
Newport Base** N/S



342MUL-8 5/8 x 8-1/4
**Ultralight Imperial/
#175 Base** N/S
[FORMERLY 357MUL]



380MUL 1 x 8-1/2
Ultralight Savannah Base S

ultralight (MUL) & light density (LDF) mdf | base



(items are approximate scale only)

8-1/2" Base

lengths available: 16'

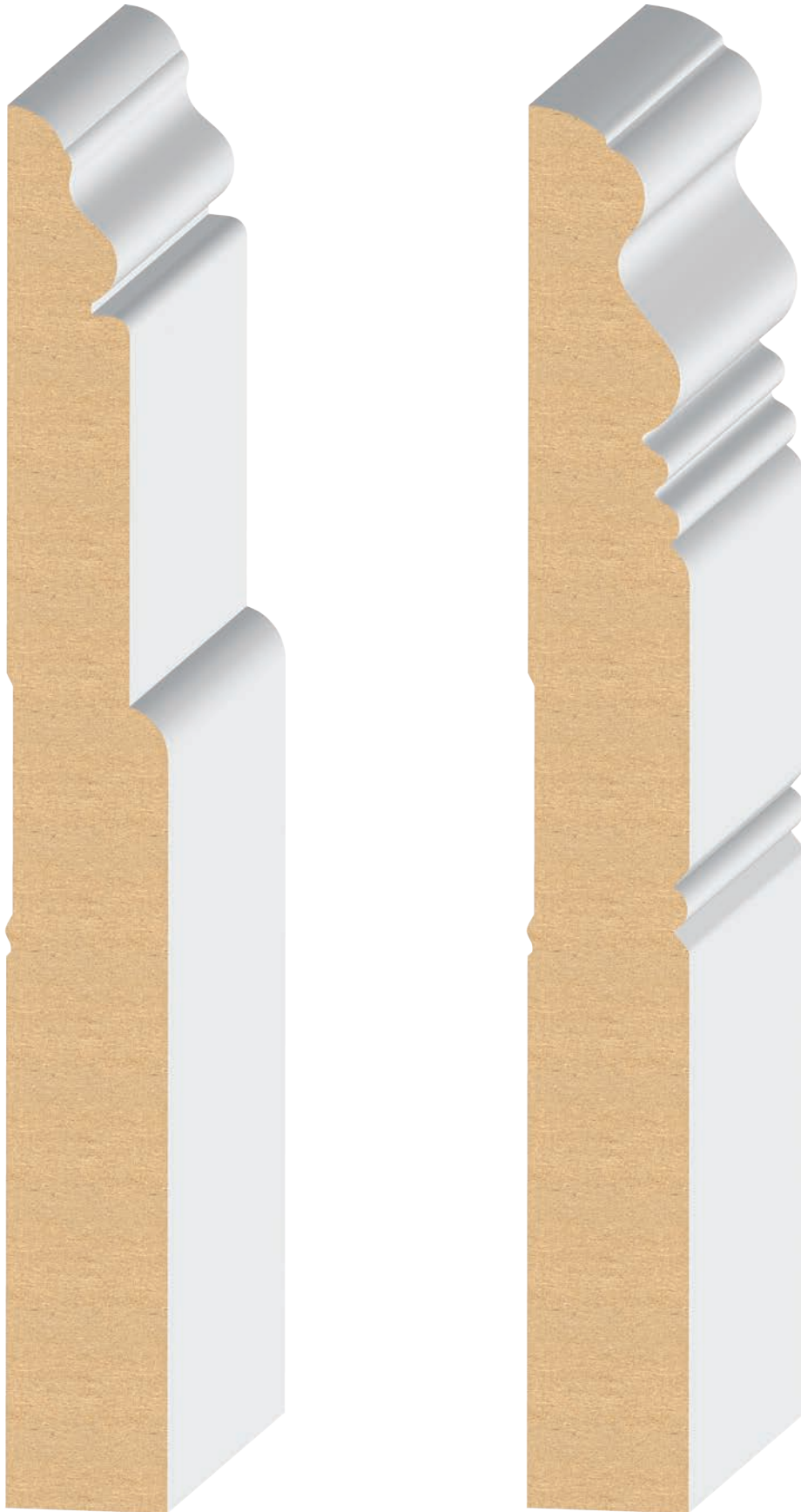

381MUL 1 x 8-1/2 Ultralight Camden Base **S**

382MUL 1 x 8-1/2 Ultralight Williamsburg Base **S**



9-1/4" Base

lengths available: 16'

(items are approximate scale only)



338MUL-9

9/16 x 9-1/4

Ultralight Santa Fe/#175 Base N/S

[FORMERLY 384MUL]



361MUL-9

9/16 x 9-1/4

Ultralight Monterey/Sonoma Base N/S

[FORMERLY 383MUL]



(items are approximate scale only)

Pediment Crown

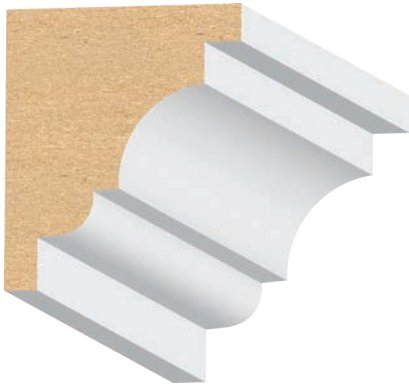

438MUL 1-3/16 x 1-1/2
Ultralight Pediment Crown N/S



419MUL 1 x 1-7/8
Ultralight Corner Crown/Mold N/S



440MUL 1-3/8 x 2-3/4
Ultralight Classic Pediment Crown N/S



439MUL 1-3/16 x 3
Ultralight Pediment Crown N/S

1-7/8" to 3-1/4" Crown Mold

(items are approximate scale only)

✂ lengths available: 16'



420MUL 9/16 x 1-7/8
Ultralight Bed Mold **S**

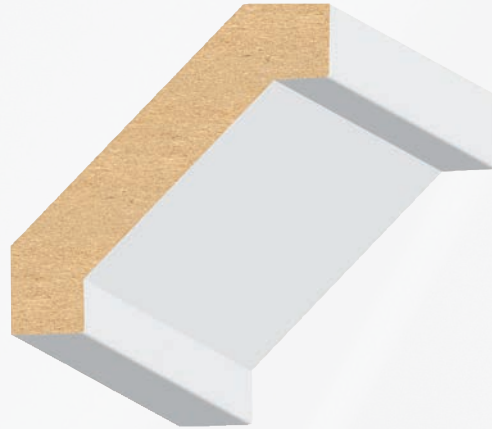

460MUL-2 9/16 x 2-3/8
Ultralight Craftsman Crown **N/S**

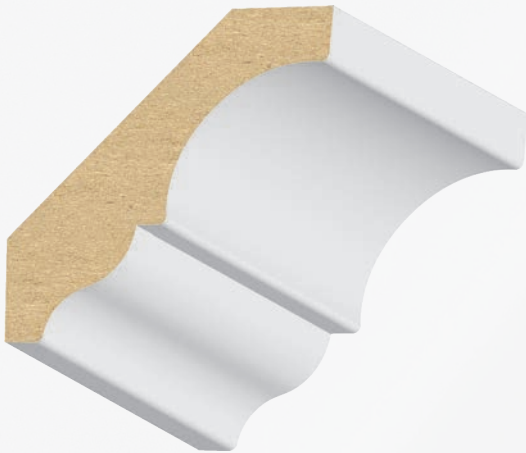

462MUL-2 9/16 x 2-7/16
Ultralight Ogee Crown **N**



402MUL 9/16 x 2-1/2
Ultralight Bed Mold/Crown **S**



404MUL 9/16 x 2-5/8
Ultralight Colonial Crown **S**
[FORMERLY 401MUL]



405MUL 9/16 x 3-1/4
Ultralight Colonial Crown **S**

436MUL 9/16 x 2-3/4
Ultralight Colonial Crown **N/S**

(items are approximate scale only)

3-1/4" to 3-7/16" Crown Mold

lengths available: 16'

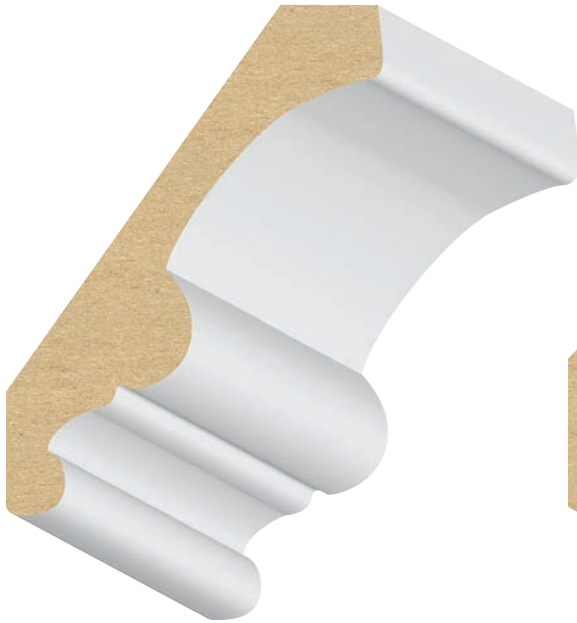

441MUL 11/16 x 3-1/4
Ultralight Single Beaded Crown N/S

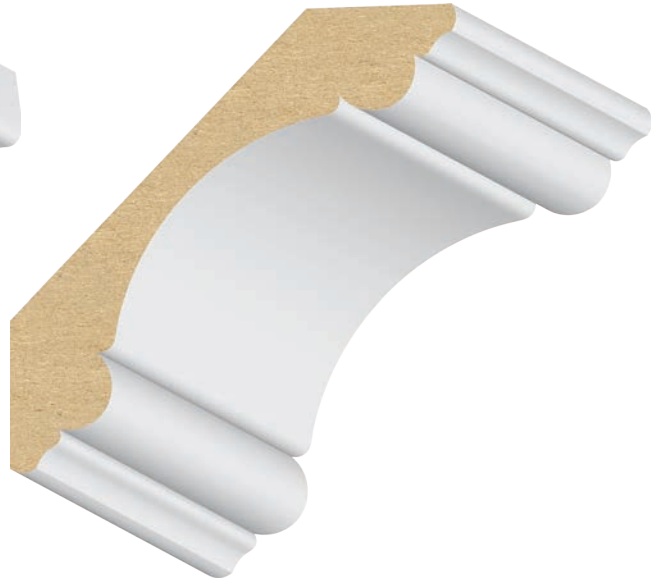

421MUL 3/4 x 3-3/8
**Ultralight Double Bead
Carolina Crown** N/S



444MUL-3 9/16 x 3-3/8
Ultralight Contemporary Crown N/S

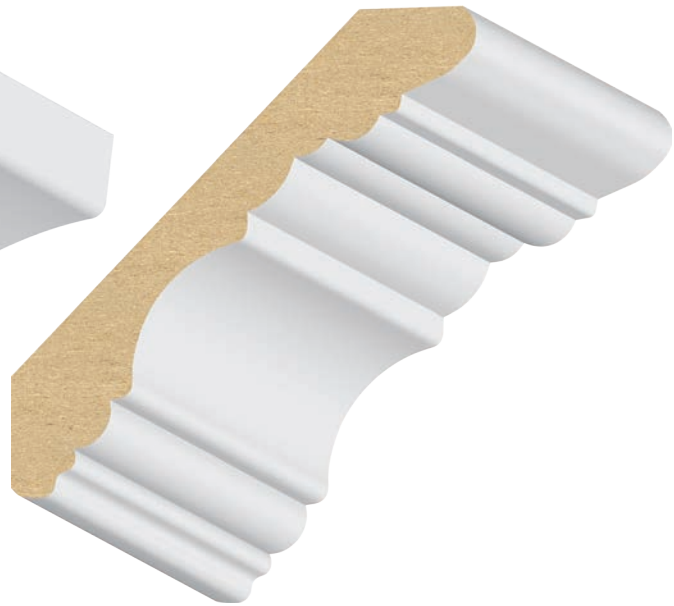

426MUL 9/16 x 3-7/16
**Ultralight Coronado/
Georgian Crown** N/S

3-5/8" to 4-1/4" Crown Mold

(items are approximate scale only)

✂ lengths available: 16'

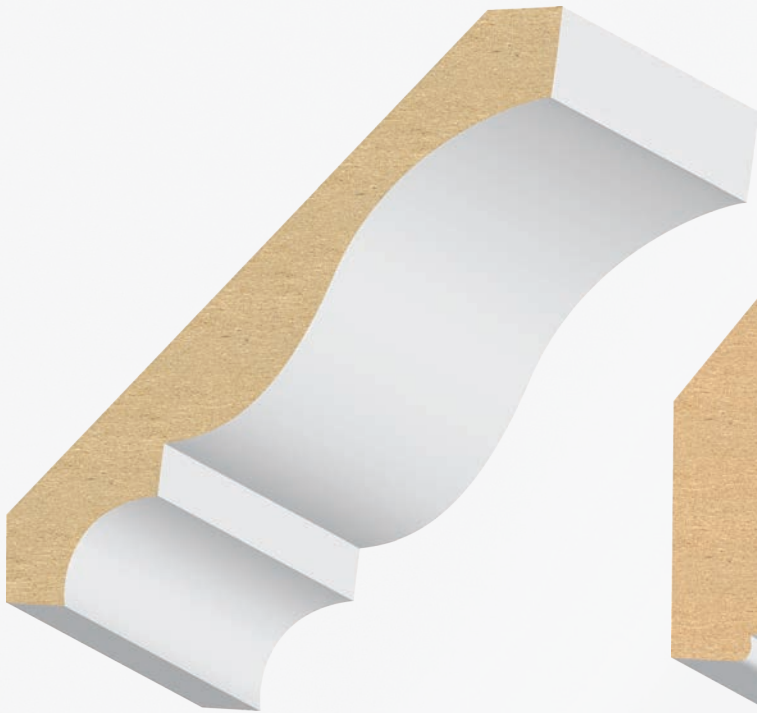

446MUL 5/8 x 3-5/8
Ultralight Colonial Crown N/S



451MUL 1-3/16 x 3-3/4
Ultralight Cornice Crown S
[FORMERLY 411MUL]



425MUL-3 3/4 x 3-3/4
Ultralight Dentil Ready Crown N/S

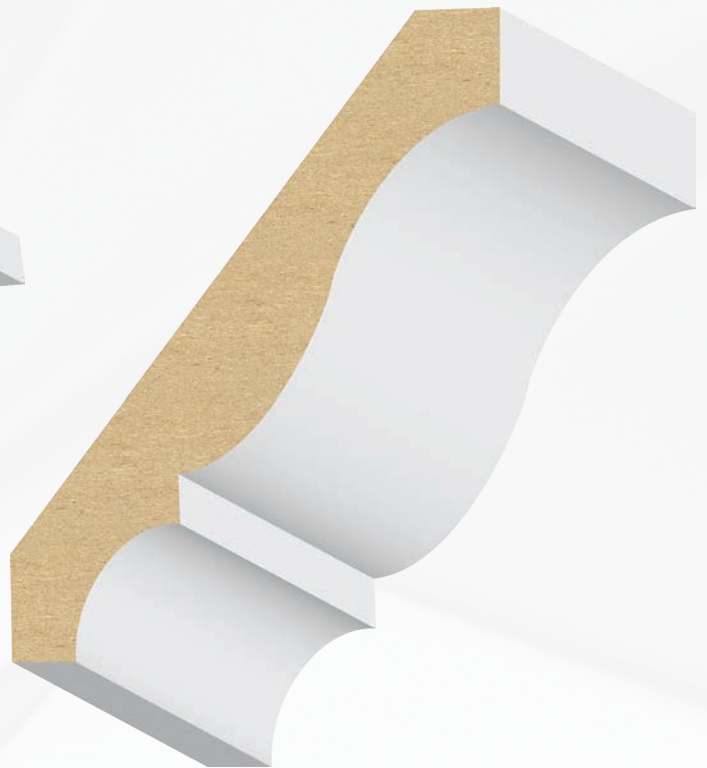

406MUL 9/16 x 4-1/4
Ultralight Colonial Crown N/S



(items are approximate scale only)

4-1/4" Crown Mold

lengths available: 16'



407MUL 1-3/16 x 4-1/4
Ultralight Cornice Crown S

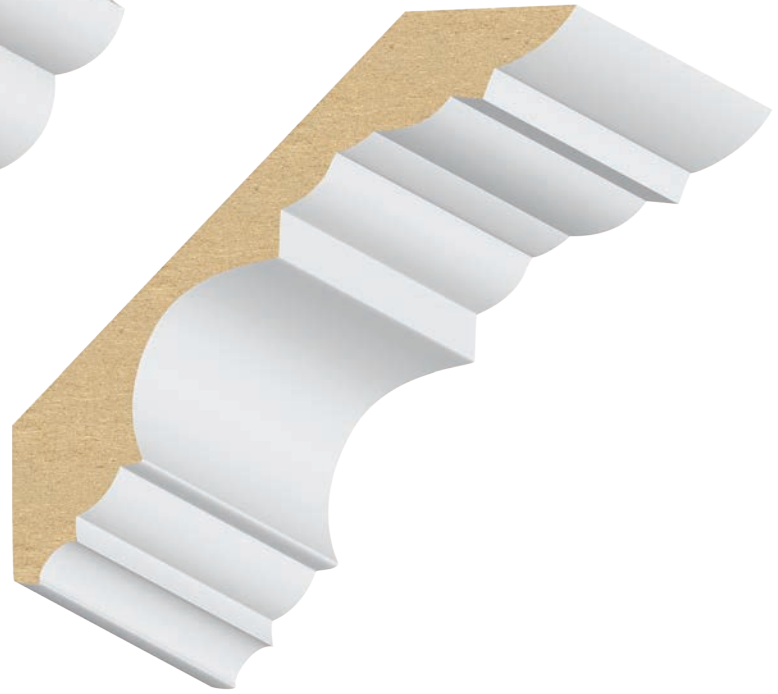

467MUL 3/4 x 4-1/4
Ultralight Tempe Crown S

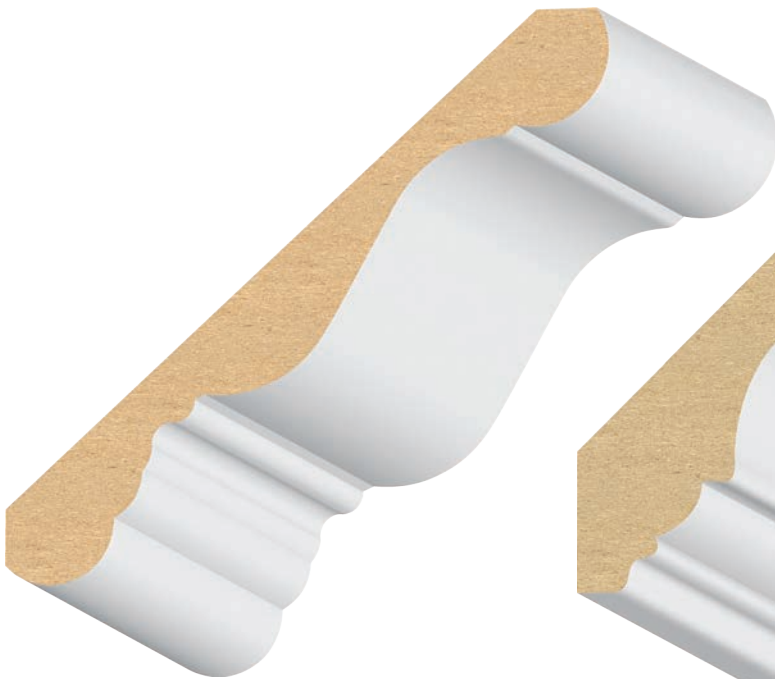

410MUL-4 9/16 x 4-1/4
Ultralight Small Charleston Crown N/S
[FORMERLY 413MUL]



434MUL 7/8 x 4-1/4
Ultralight Coronado Crown N

4-1/4" to 4-1/2" Crown Mold

(items are approximate scale only)

lengths available: 16'

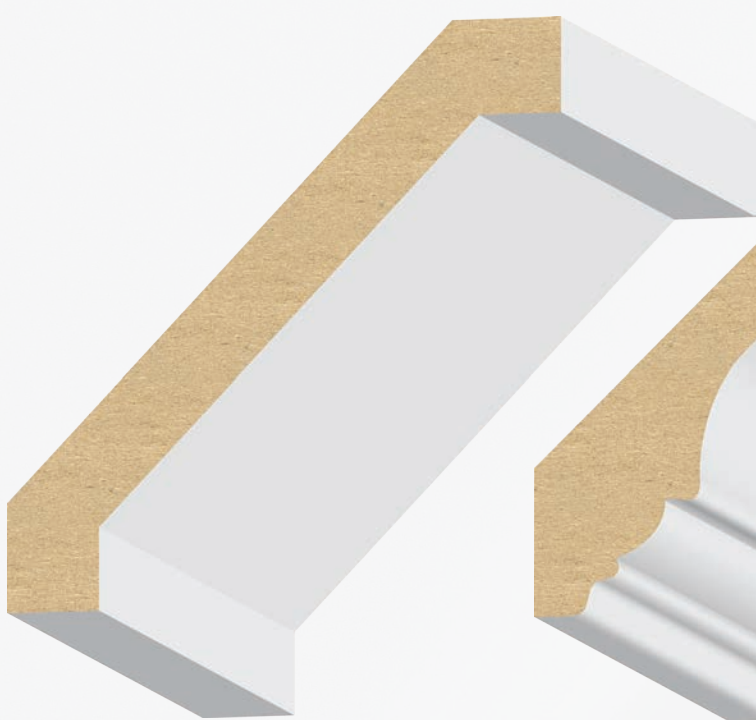

460MUL-4 11/16 x 4-1/4
Ultralight Craftsman Crown N/S



412MUL 9/16 x 4-1/2
Ultralight Coronado/Georgian Crown N/S



422MUL 9/16 x 4-1/2
Ultralight Savannah Crown S



409MUL 3/4 x 4-1/2
Ultralight Rancho Crown N/S



(items are approximate scale only)

4-1/2" to 4-5/8" Crown Mold

lengths available: 16'

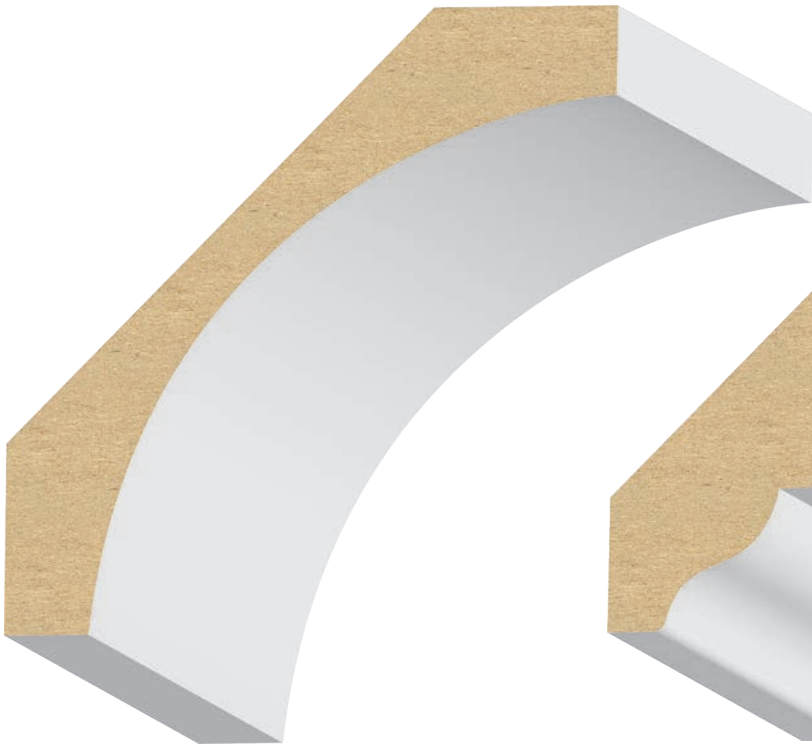

444MUL-4 1 x 4-1/2
Ultralight Contemporary Crown N/S



462MUL-4 3/4 x 4-9/16
Ultralight Ogee Crown N



408MUL-4 3/4 x 4-5/8
Ultralight Cornice N/S

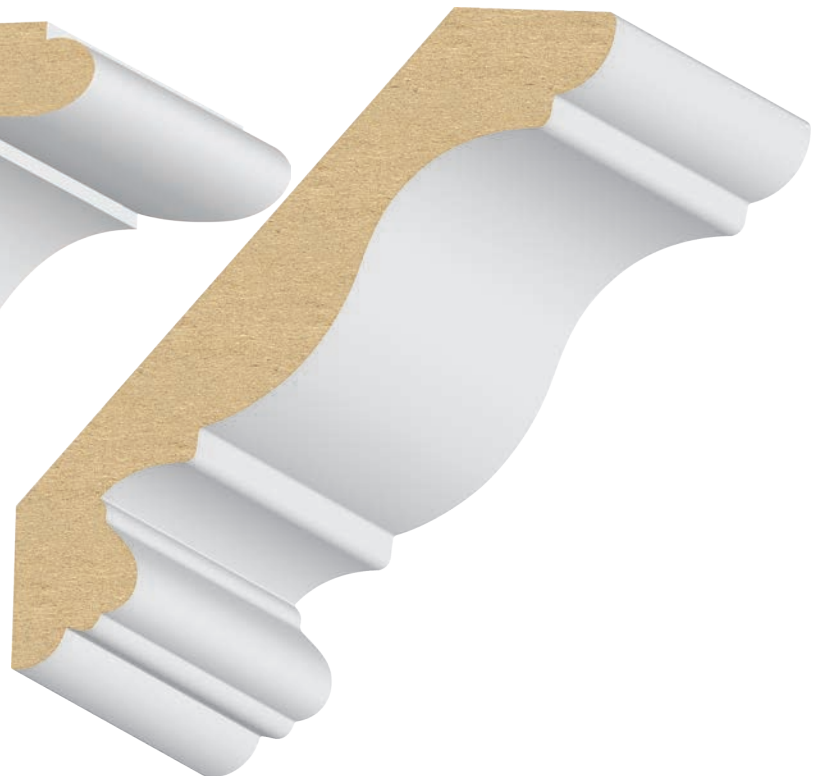

411MUL-4 3/4 x 4-5/8
Ultralight Rafael Crown N/S

4-5/8" to 5" Crown Mold

(items are approximate scale only)

lengths available: 16'

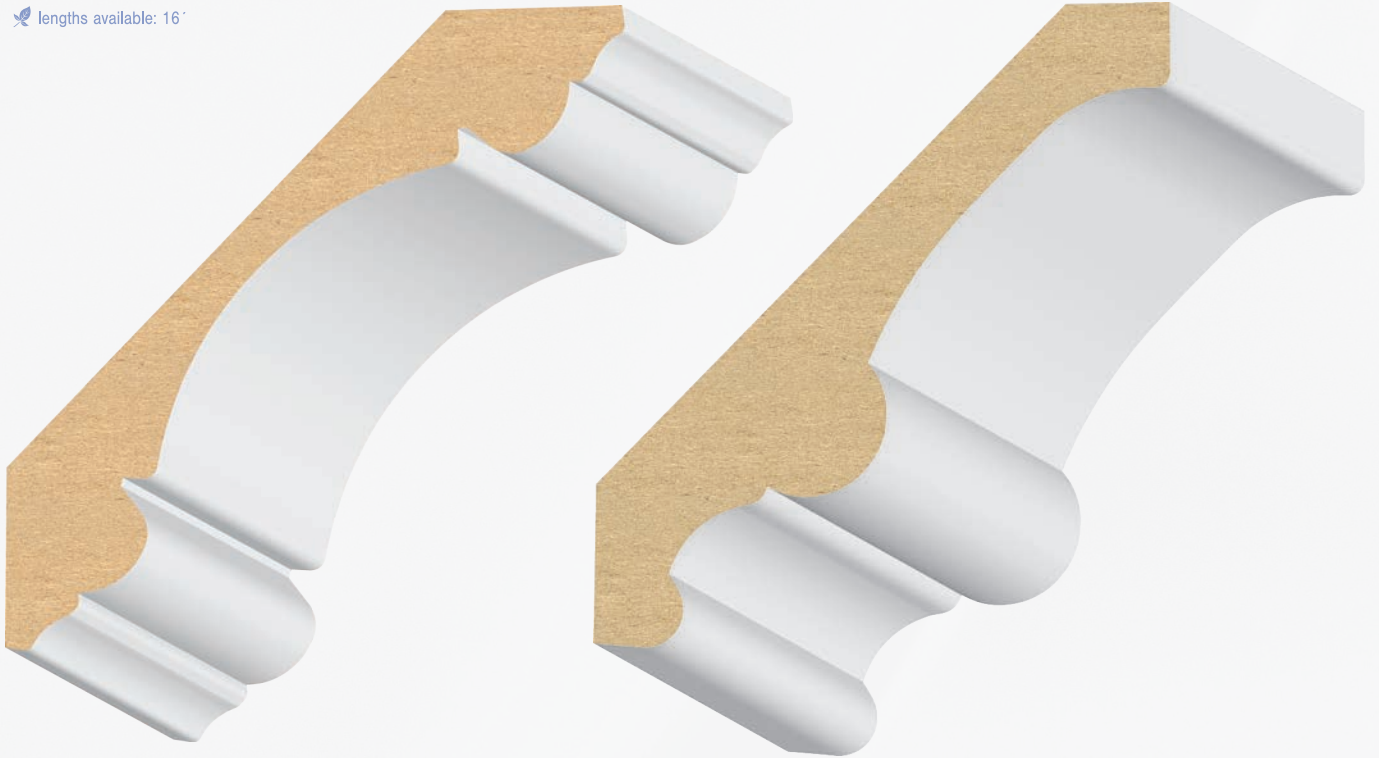

423MUL 7/8 x 4-5/8
Ultralight Double Bead Carolina Crown N/S
423BMUL 11/16 x 4-5/8
Ultralight Double Bead Carolina Crown N/S

442MUL 11/16 x 4-5/8
Ultralight Single Beaded Crown N/S
 [FORMERLY 430MUL]



469MUL 3/4 x 4-11/16
Ultralight Scottsdale Crown S

410MUL-5 11/16 x 5
Ultralight Charleston Crown N/S



(items are approximate scale only)

5" to 5-1/4" Crown Mold

lengths available: 7' & 17'



465LDF-5 1-1/4 x 5
LDF King George Crown **NEW** **s**



455LDF 11/16 x 5-1/16
Ultralight Dentil Crown **N/S**



460MUL-5 3/4 x 5-1/4
Ultralight Craftsman Crown **N/S**

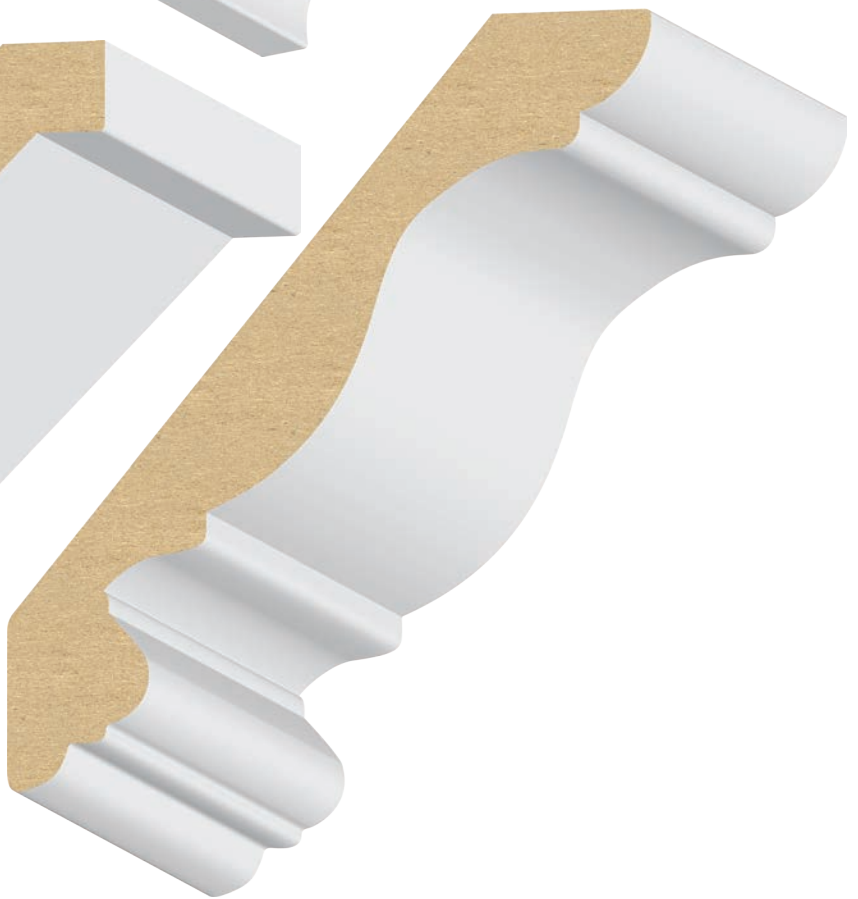

411MUL-5 3/4 x 5-1/4
Ultralight Rafael Crown **N/S**

5-1/4" Crown Mold

lengths available: 16'

(items are approximate scale only)



414MUL 9/16 x 5-1/4 **Ultralight Colonial Crown** N/S
(larger cove at bottom; for smaller cove see 414LDF)



414LDF 9/16 x 5-1/4 **Colonial Crown** N
(smaller cove at bottom; for larger cove see 414MUL)



(items are approximate scale only)

5-1/2" to 5-5/8" Crown Mold

lengths available: 16'

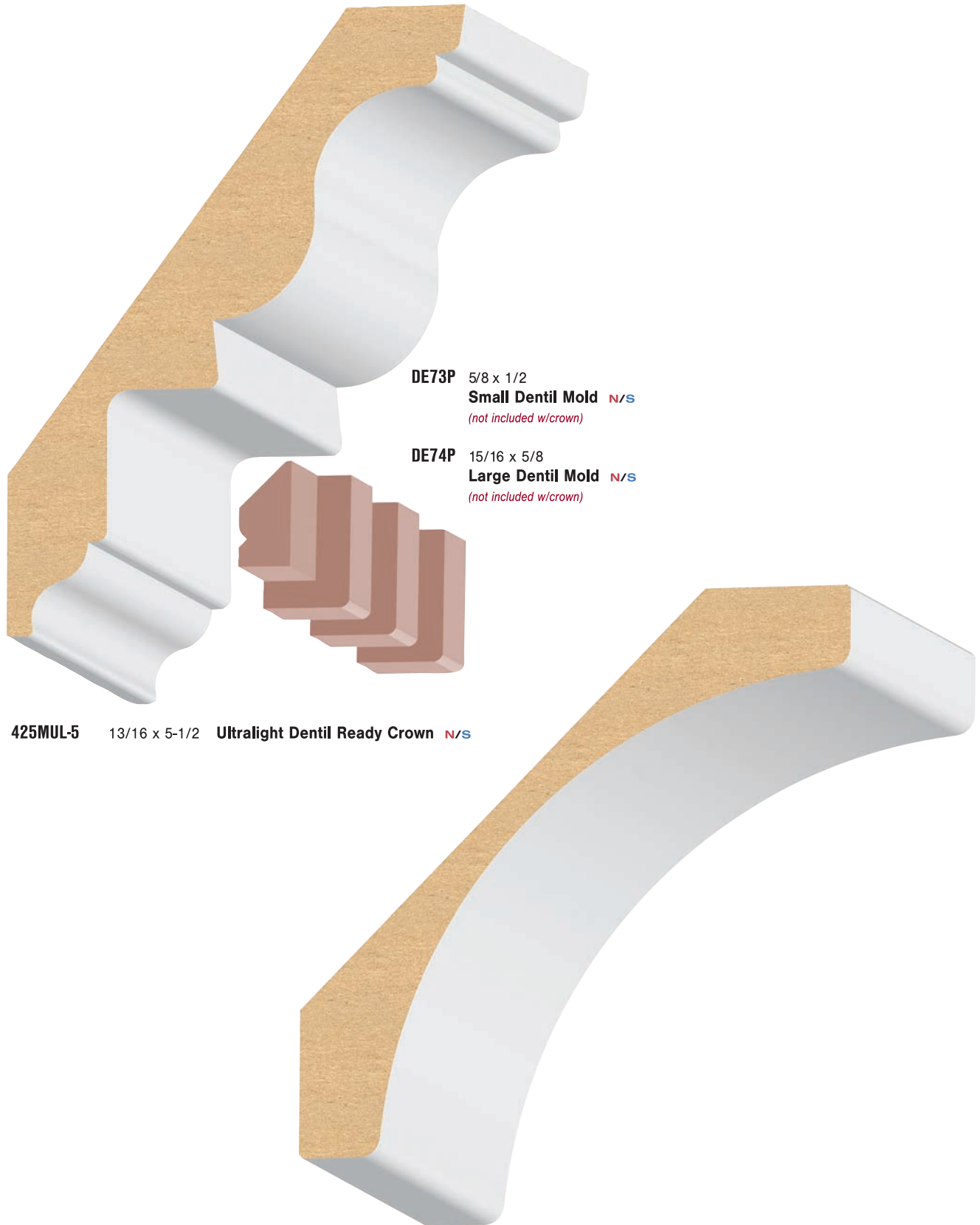

DE73P 5/8 x 1/2
Small Dentil Mold N/S
(not included w/crown)

DE74P 15/16 x 5/8
Large Dentil Mold N/S
(not included w/crown)

425MUL-5 13/16 x 5-1/2 **Ultralight Dentil Ready Crown** N/S

444MUL-5 1-1/16 x 5-5/8 **Ultralight Contemporary Crown** N/S
[FORMERLY 444MUL]



6" Crown Mold

lengths available: 16'

(items are approximate scale only)



408MUL-6 1 x 6 **Ultralight Cornice** N/S
[FORMERLY 408MUL]



410MUL-6 1 1/16 x 6 **Ultralight Charleston Crown** N/S
[FORMERLY 410MUL]



453MUL 1-3/16 x 6
**Ultralight Nantucket/
La Costa Crown** N/S



(items are approximate scale only)

6" to 6-1/4" Crown Mold

lengths available: 16'



462MUL-6 7/8 x 6 **Ultralight Ogee Crown** N



435MUL 1 x 6-1/4 **Ultralight Regal Crown** N/S



6-1/4" to 6-7/16" Crown Mold

(items are approximate scale only)

✂ lengths available: 16'



411MUL-6 3/4 x 6-1/4 **Ultralight Rafael Crown** N/S



448MUL 3/4 x 6-7/16 **Ultralight Cape Cod Crown** N/S

(items are approximate scale only)

6-1/2" Crown Mold

lengths available: 16

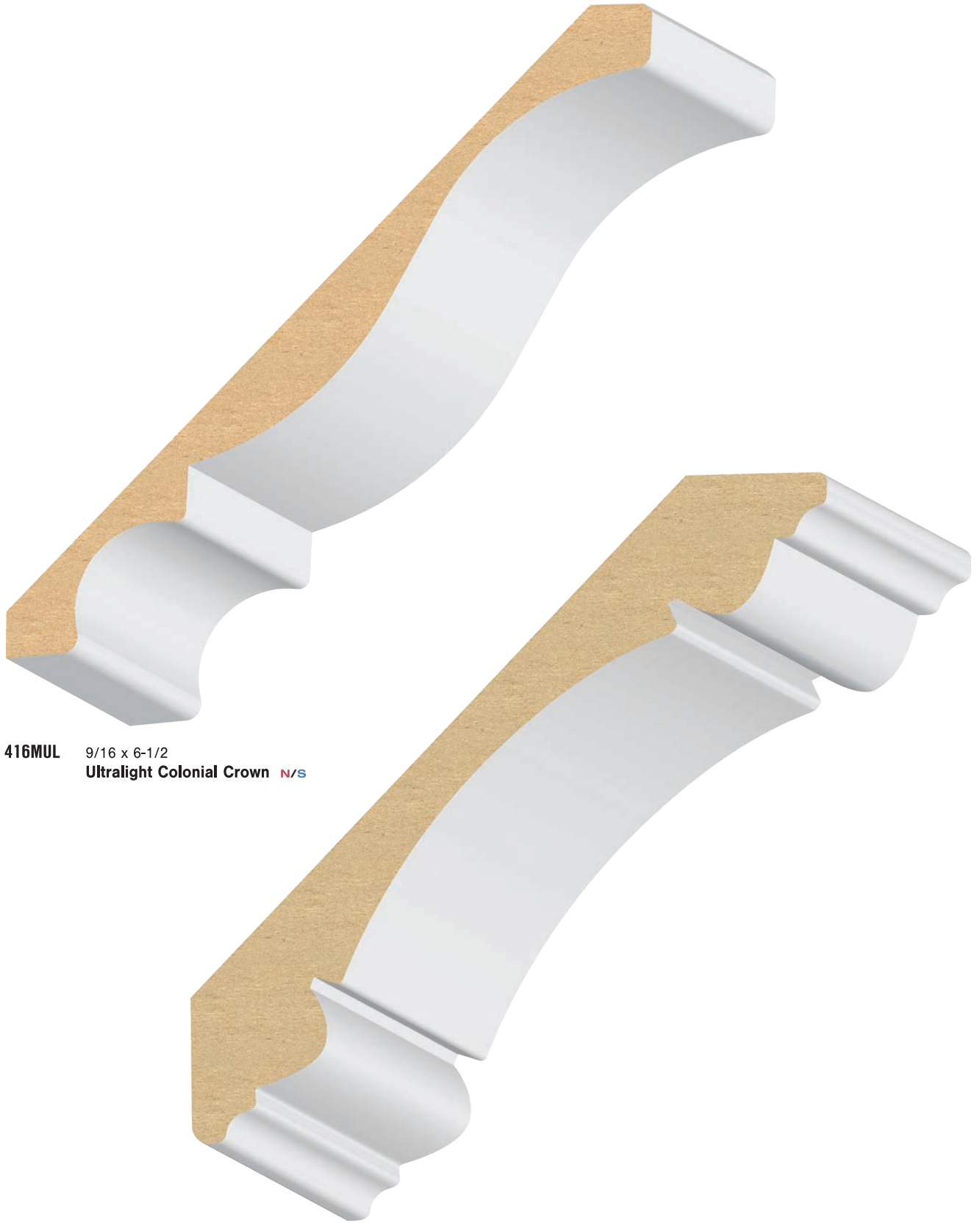

416MUL 9/16 x 6-1/2
Ultralight Colonial Crown N/S

424MUL-6 1 x 6-1/2
Ultralight Double Bead Carolina Crown N/S
[FORMERLY 424MUL]



6-9/16" Crown Mold

(items are approximate scale only)

✂ lengths available: 16'

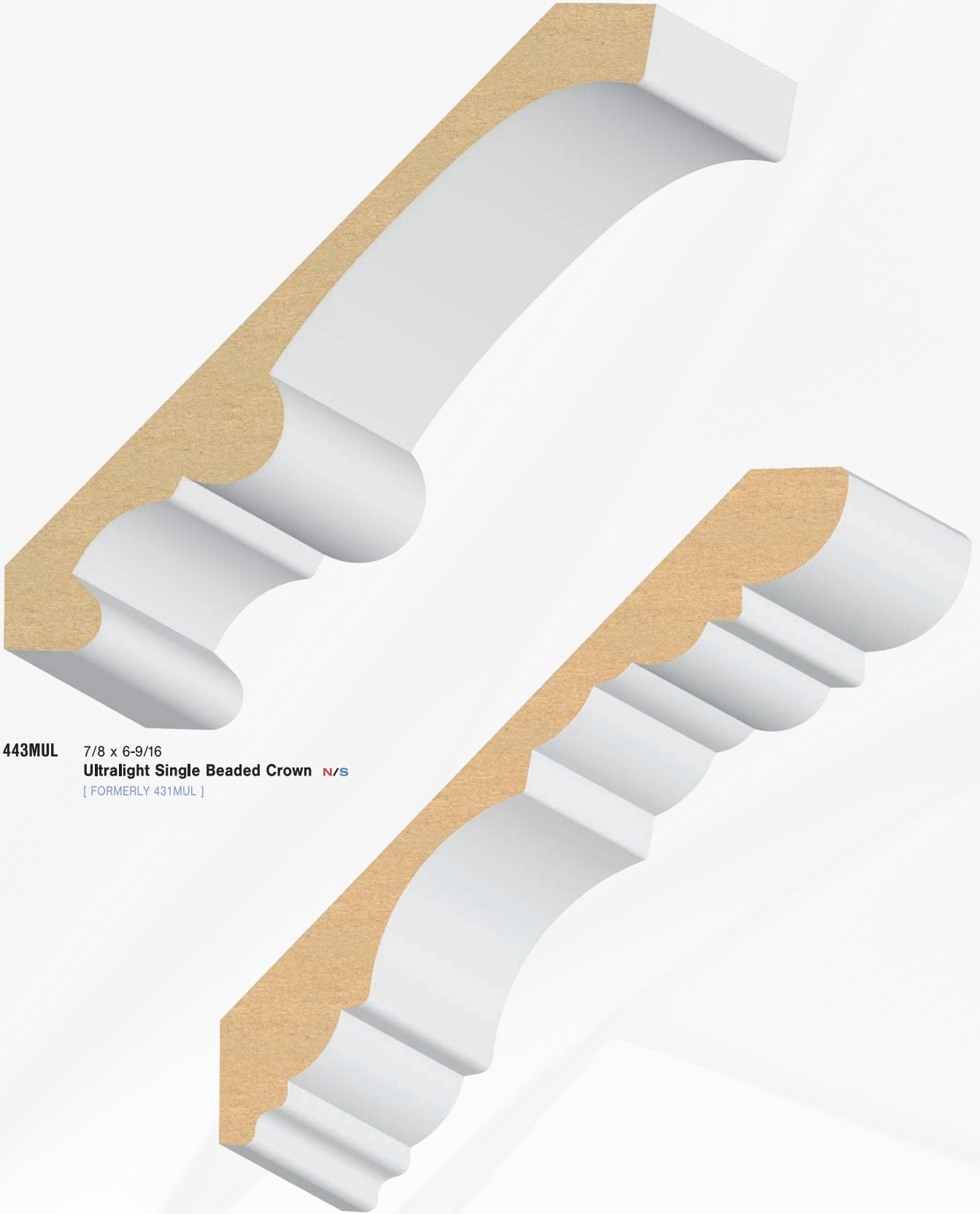

443MUL 7/8 x 6-9/16
Ultralight Single Beaded Crown N/S
 [FORMERLY 431MUL]

447MUL 7/8 x 6-9/16 **Ultralight Coronado Crown** N
427MUL 3/4 x 6-1/2 **Ultralight Georgian Crown** S



6-3/4" to 6-7/8" Crown Mold

lengths available: 16'

(items are approximate scale only)

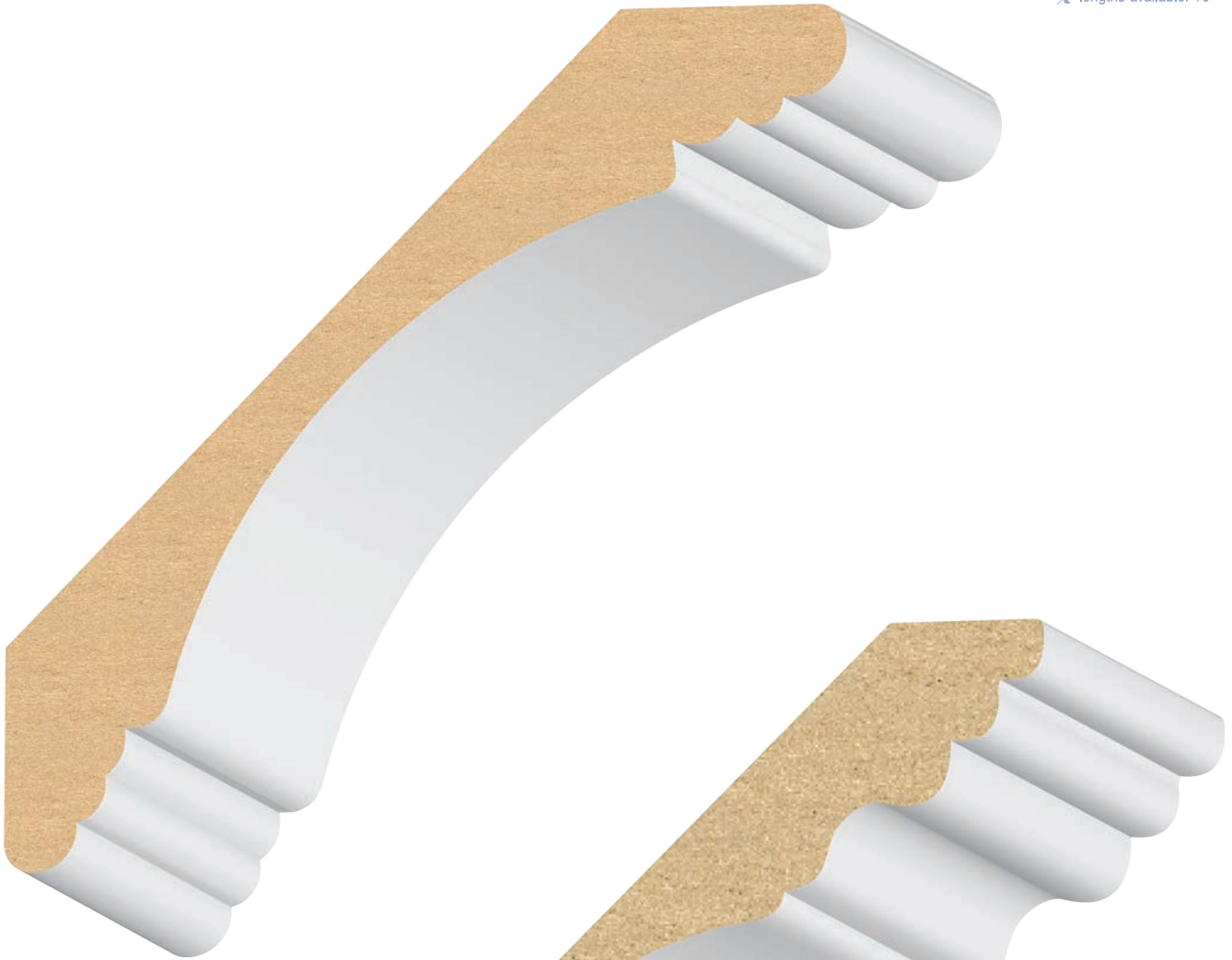

433MUL 1-3/16 x 6-3/4
Ultralight Del Mar Crown s

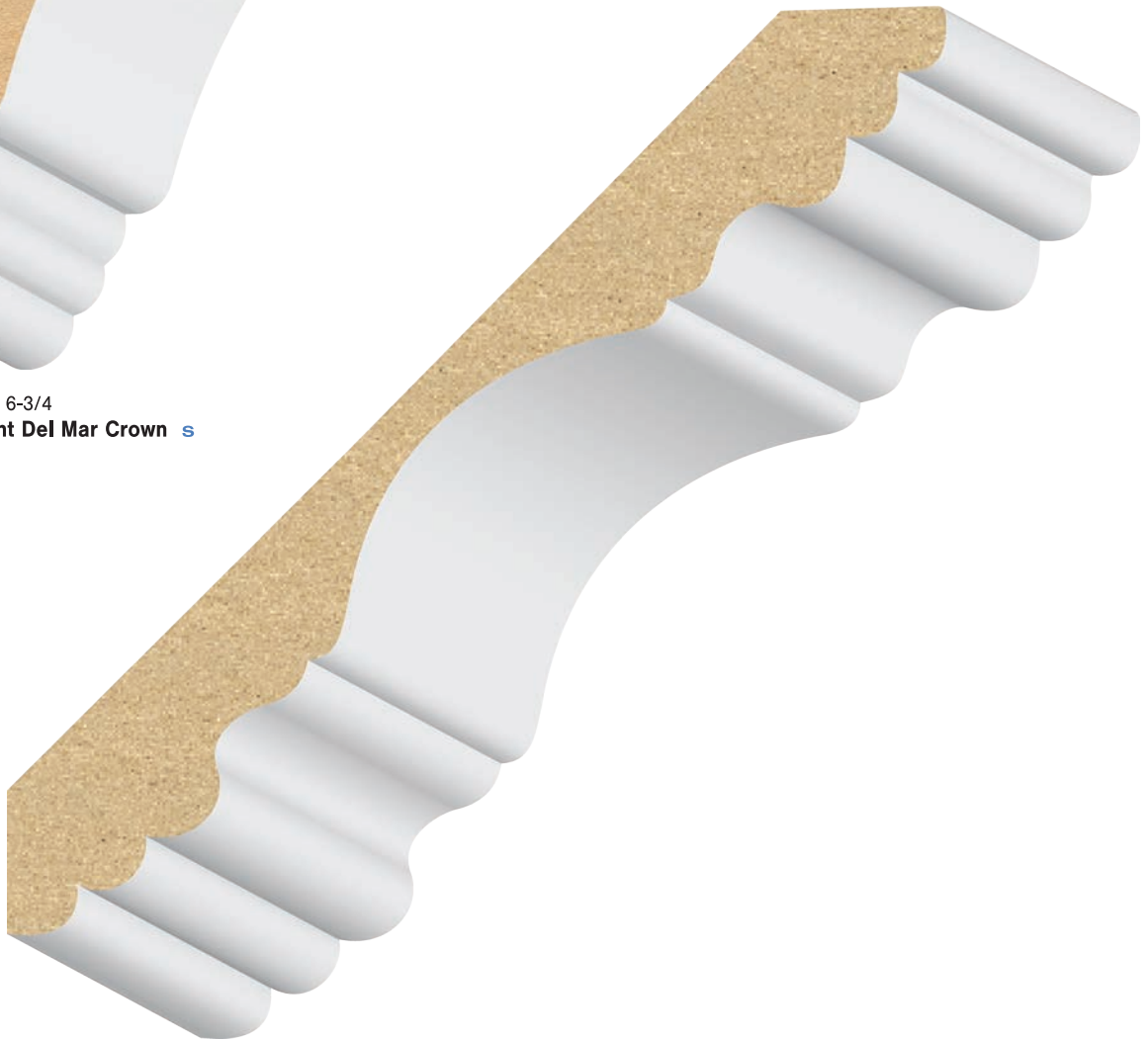

437MUL 13/16 x 6-7/8
Ultralight Santa Clara Crown N/S



7" to 7-3/16" Crown Mold

(items are approximate scale only)

✂ lengths available: 16'

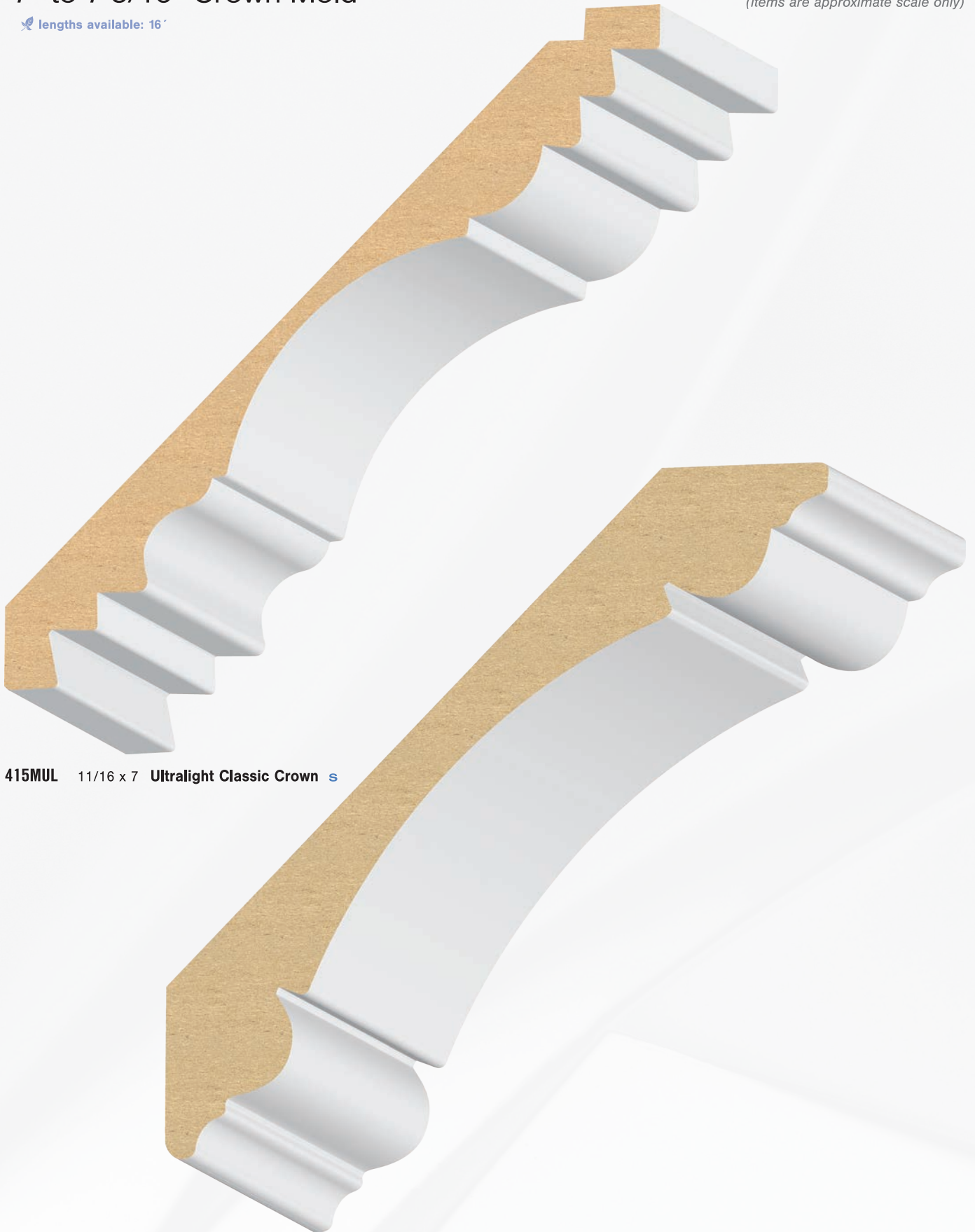

415MUL 1 1/16 x 7 **Ultralight Classic Crown** **S**

424MUL-7 1-1/8 x 7-3/16 **Ultralight Double Bead Carolina Crown** **N/S**
424LDF-7 1 x 7-3/16 **LDF Double Bead Carolina Crown** **N**

7-1/4" Crown Mold

lengths available: 16'

(items are approximate scale only)

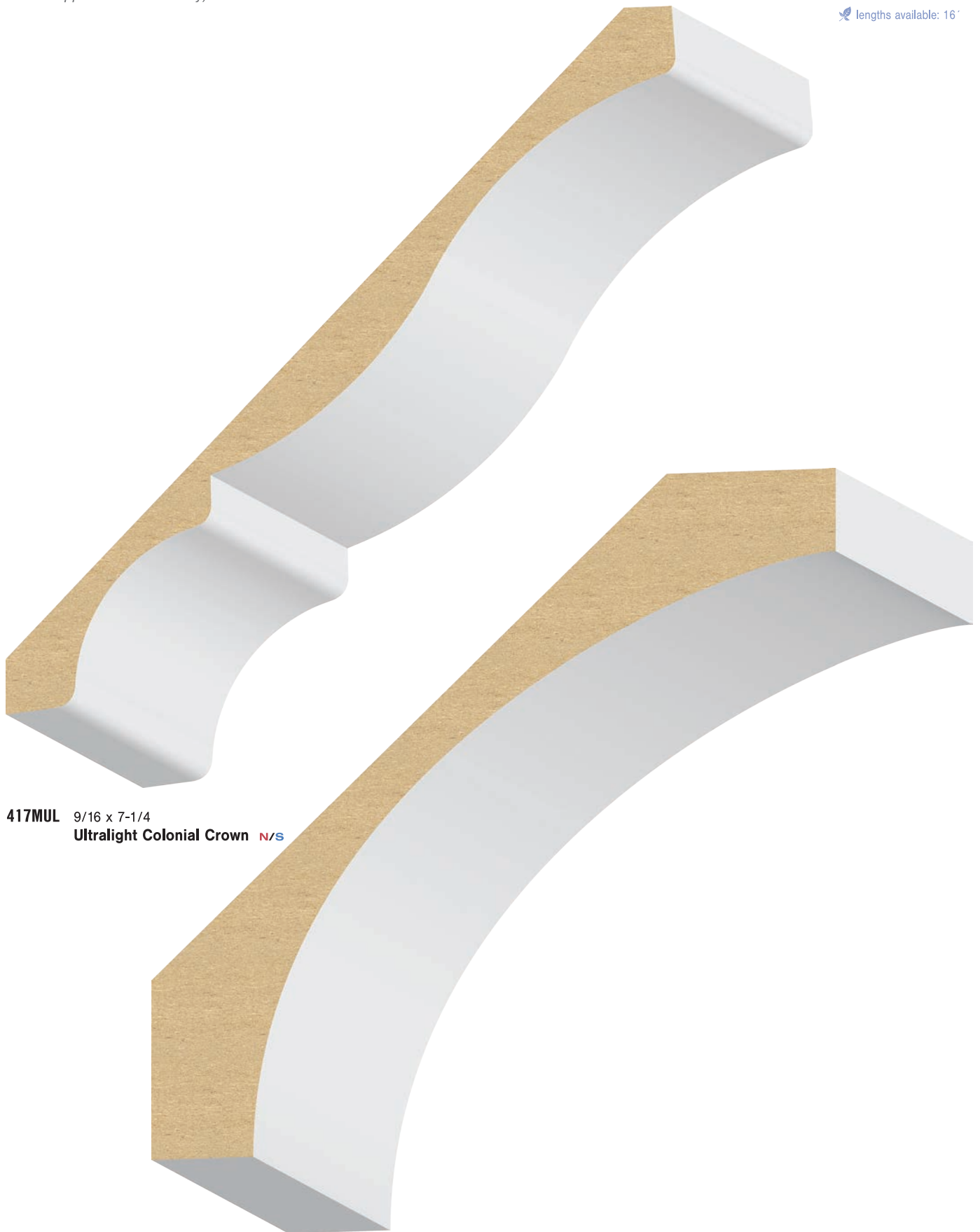

417MUL 9/16 x 7-1/4
Ultralight Colonial Crown N/S

444MUL-7 1-3/16 x 7-1/4
Ultralight Contemporary Crown N/S
 [FORMERLY 445MUL]



7-1/4" to 8" Crown Mold

lengths available: 16'

(items are approximate scale only)

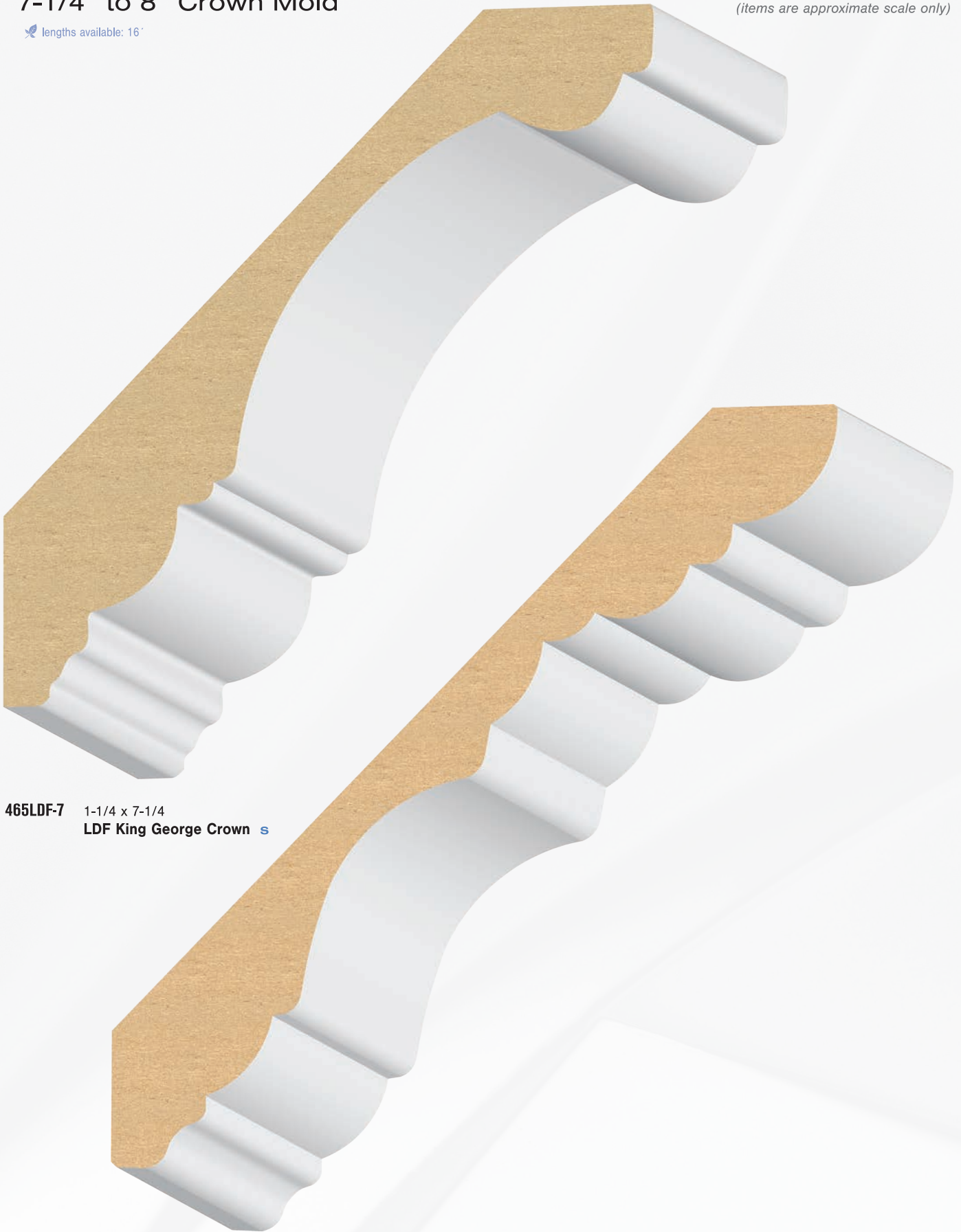

465LDF-7 1-1/4 x 7-1/4
LDF King George Crown s

428MUL 1-1/16 x 8 **Ultralight Coronado/Georgian Crown** n/s



(items are approximate scale only)

8" to 8-1/2" Crown Mold

lengths available: 16'

410MUL-8 1 x 8
**Ultralight Large
Charleston Crown** N/S
[FORMERLY 450MUL]

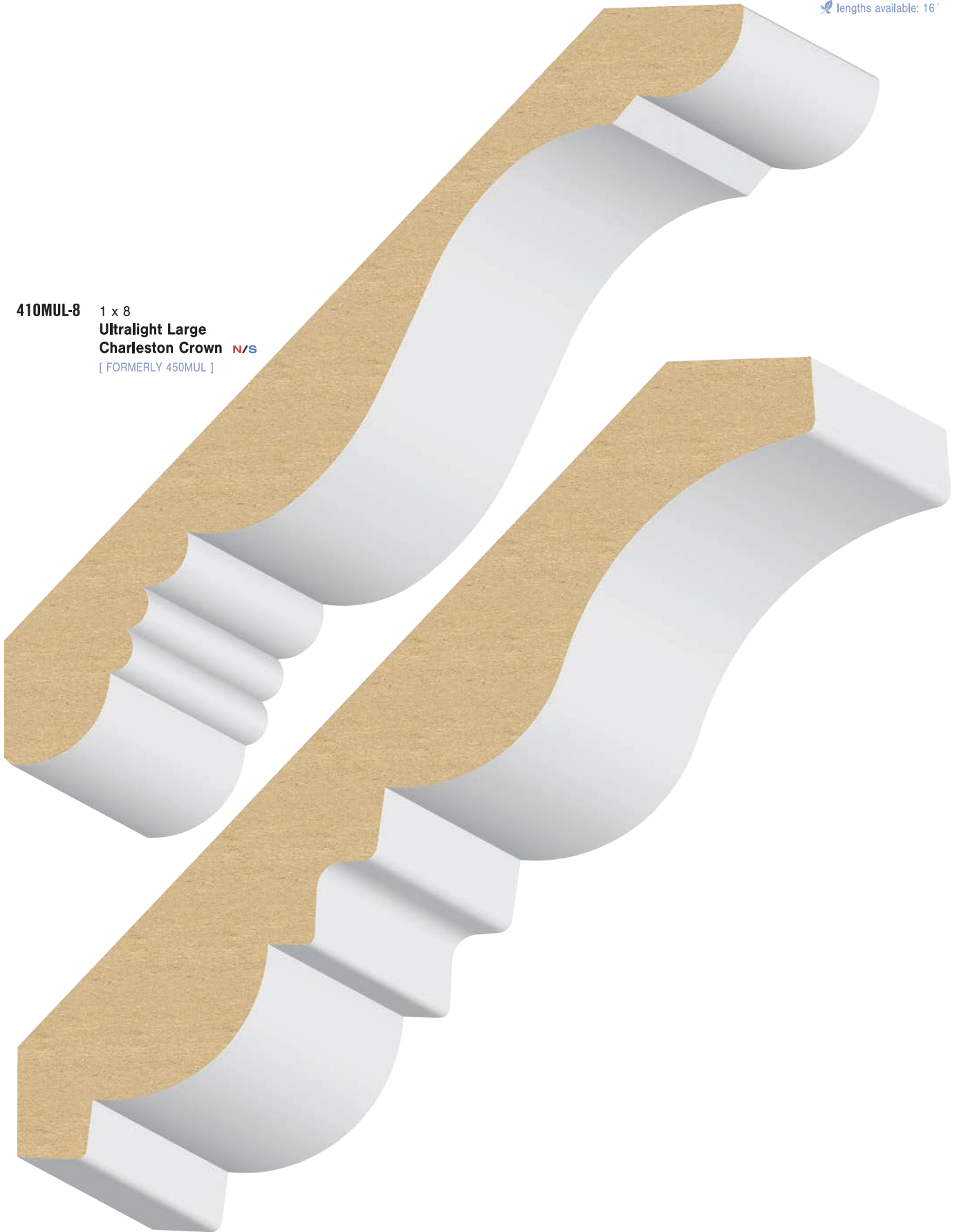

432MUL 1-3/16 x 8-1/2 **Ultralight Corona Crown** N/S



8-1/2" Crown Mold

lengths available: 16'

(items are approximate scale only)



454MUL 1-3/16 x 8-1/2 **Ultralight Del Mar Crown s**



(items are approximate scale only)

8-7/8" Crown Mold

lengths available: 16'



449MUL 11/16 x 8-7/8 **Ultralight Colonial Crown** N/S



11-1/4" Crown Mold

lengths available: 16'

(items are approximate scale only)

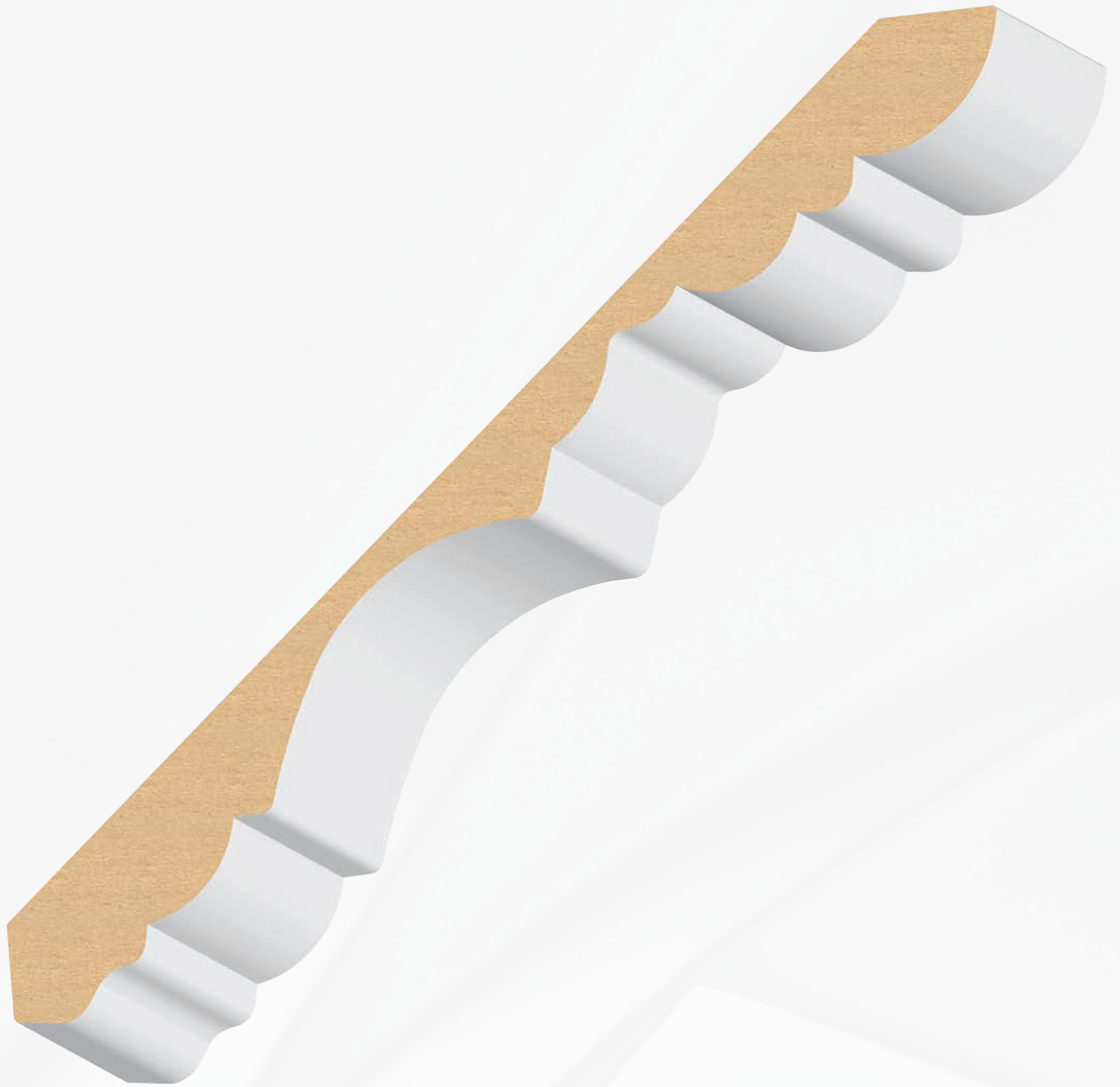

429MUL 1 x 11-1/4 **Ultralight Coronado/Georgian Crown** N/S
(NOT TO SCALE)



(items are approximate scale only)

Chair Rail



651MUL 9/16 x 2-1/2
Ultralight Chair Rail N/S



655MUL 9/16 x 2-5/8
Ultralight Colonial Chair Rail N/S



648MUL 1 x 3
Ultralight Bolection Chair Rail N/S



649MUL 3/4 x 3
Ultralight Bead & Barrel Chair Rail N/S



653MUL 11/16 x 3
Ultralight Colonial Chair Rail N/S



647MUL 1 x 3-1/2
Ultralight Malibu Chair Rail N/S



656MUL 5/8 x 4-1/2
Ultralight Traditional Chair Rail N/S



Panel Cap

lengths available: 16'

(items are approximate scale only)



739MUL 1-1/16 x 1-5/16
Ultralight Panel Cap N/S
 [with 1/4" x 11/16" Rab't]



738MUL 1-1/8 x 1-3/4
Ultralight Panel Cap N/S
 [with 5/16" x 5/8" Rab't]



733MUL 1-3/16 x 2
Ultralight Panel Cap N/S
 [with 3/4" Rab't]



737MUL 3/4 x 2
Ultralight Panel Cap N/S
 [with 1/4" x 1/2" Rab't]



729LDF 9/16 x 2-1/4
LDF Wainscot Cap S
 [with 3/8" Rab't]



734MUL 1 x 2-1/2
Ultralight Panel Cap N/S
 [with 3/8" Rab't]



740LDF 1 x 2-1/2
Ultralight Contemporary Cap N/S
 [with 5/8" Rab't]

flat astragal/panel mold

lengths available: 7' & 16'

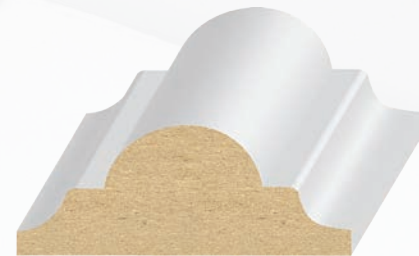

646MUL 11/16 x 1-3/4
Ultralight Flat Astragal/Panel Mold N

660MUL 11/16 x 1-5/8
Ultralight Flat Astragal/Panel Mold S

Wainscoting

lengths available: 16'

(items are approximate scale only)



- 2001LDF** 3/8 x 3-1/2 LDF Flat T&G Wainscot N/S
- 2003LDF** 3/8 x 5-1/2 LDF Flat T&G Wainscot N/S



- 2000LDF** 3/8 x 3-1/2 LDF Beaded T&G Wainscot N/S
- 2002LDF** 3/8 x 5-1/2 LDF Beaded T&G Wainscot N/S



- 2005MUL** 1/4 x 7 Ultralight Beaded T&G Wainscot S
- 2005LDF** 3/8 x 7-1/4 LDF Beaded T&G Wainscot N



- 2007LDF** 5/8 x 5-1/2 LDF Reversible V-Groove/Nickel Gap T&G N/S
- 2008LDF** 5/8 x 7-3/8 LDF Reversible V-Groove/Nickel Gap T&G N/S

lengths available: 16'

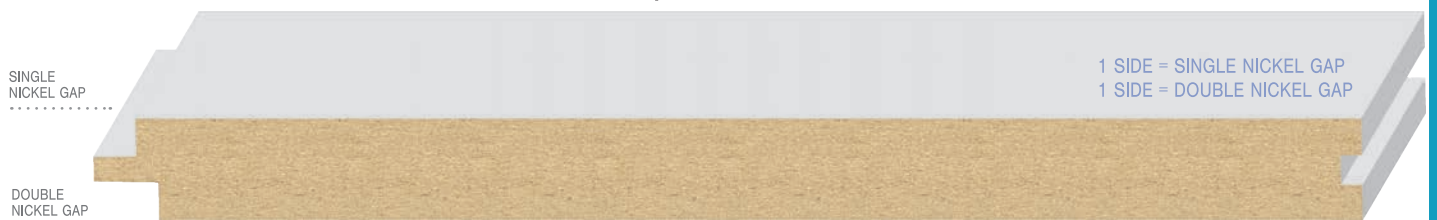

- 2009LDF** 5/8 x 7-3/8 LDF Single/Double Nickel Gap T&G Wainscot N/S

wainscoting | ultralight (mul) & light density (LDF) mdf

Hook

lengths available: 16'



15FB 9/16 x 3-1/4 **Fiberboard 1 Eased Edge Hookstrip** N/S

Cleat

lengths available: 16'



10FB 9/16 x 1-1/2 **Fiberboard 1 Eased Edge Cleat** N/S

(items are approximate scale only)

Window Stool

lengths available: 16'



Ultralight Primed

| | | | |
|-----------------|----------------|-------------------|----------|
| PR990MUL | 11/16 x 4-3/4 | Ogee Stool | N |
| PR992MUL | 11/16 x 5-1/4 | Ogee Stool | N |
| PR993MUL | 11/16 x 6-1/2 | Ogee Stool | N |
| PR994MUL | 11/16 x 7-1/4 | Ogee Stool | N |
| PR999MUL | 1-3/16 x 8-1/4 | Ogee Stool | N |

Primed LDF

| | | | |
|-----------------|---------------|-------------------|----------|
| PR990LDF | 11/16 x 4-3/4 | Ogee Stool | N |
| PR992LDF | 11/16 x 5-1/4 | Ogee Stool | N |
| PR993LDF | 11/16 x 6-1/2 | Ogee Stool | N |
| PR994LDF | 11/16 x 7-1/4 | Ogee Stool | N |

Unprimed LDF

| | | | |
|---------------|---------------|-------------------|------------|
| 990LDF | 11/16 x 4-3/4 | Ogee Stool | N/S |
| 991LDF | 11/16 x 6-3/4 | Ogee Stool | S |
| 992LDF | 11/16 x 5-1/4 | Ogee Stool | N |
| 993LDF | 11/16 x 6-1/2 | Ogee Stool | N |
| 994LDF | 11/16 x 7-1/4 | Ogee Stool | N |
| 999LDF | 1-1/4 x 8-1/4 | Ogee Stool | N |



986LDF 11/16 x 4-3/4 **LDF Beveled Stool** S

987LDF 11/16 x 6-3/4 **LDF Beveled Stool** S



976LDF 1 x 4-3/4 **LDF Thick Beveled Stool** N/S

977LDF 1 x 7-1/4 **LDF Thick Beveled Stool** N/S

[FORMERLY 988LDF]

[FORMERLY 989LDF]



PR995MUL 1-3/16 x 8-1/4 **Bullnose Stool Primed** N
995LDF 1-1/4 x 8-1/4 **Bullnose Stool Unprimed** N

5/8"



(items are approximate scale only)

Wall Cap

lengths available: 16'



996LDF 11/16 x 7-1/4 **Double Ogee Cap Primed N**

S4S

lengths available: 16'



E2E Wall Cap

lengths available: 16'

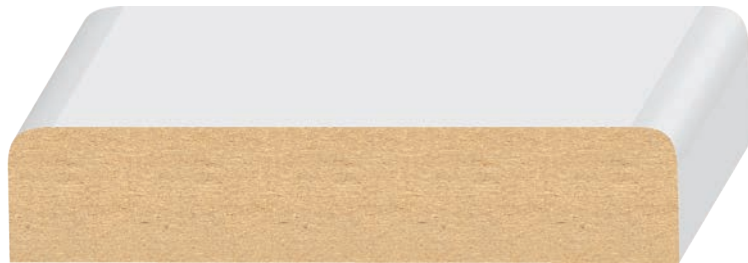

Primed Ultralight

| Product | Dimensions | Material | Finish | Lengths available |
|---------|----------------|----------|--------|------------------------|
| 713MUL | 11/16 x 1-1/2 | S4S | N/S | 16', 17' |
| 714MUL | 11/16 x 2-1/2 | S4S | N/S | 8', 16', 17' |
| 715MUL | 11/16 x 3-1/2 | S4S | N/S | 8', 10', 12', 16', 17' |
| 750MUL | 11/16 x 5-1/2 | S4S | N/S | 8', 10', 12', 16', 17' |
| 751MUL | 11/16 x 7-1/4 | S4S | N/S | 8', 10', 12', 16' |
| 752MUL | 11/16 x 9-1/4 | S4S | N/S | 8', 10', 12', 16' |
| 753MUL | 11/16 x 11-1/4 | S4S | N/S | 8', 10', 12', 16' |

Primed LDF

| Product | Dimensions | Material | Finish | Lengths available |
|---------|----------------|----------|--------|------------------------|
| 713LDF | 11/16 x 1-1/2 | S4S | N/S | 16', 17' |
| 714LDF | 11/16 x 2-1/2 | S4S | N/S | 8', 16', 17' |
| 715LDF | 11/16 x 3-1/2 | S4S | N/S | 8', 10', 12', 16', 17' |
| 750LDF | 11/16 x 5-1/2 | S4S | N/S | 8', 10', 12', 16', 17' |
| 751LDF | 11/16 x 7-1/4 | S4S | N/S | 8', 10', 12', 16' |
| 752LDF | 11/16 x 9-1/4 | S4S | S | 8', 10', 12', 16' |
| 753LDF | 11/16 x 11-1/4 | S4S | N/S | 8', 10', 12', 16' |

Primed Ultralight

| | | | |
|--------|-------------|-------------------------------|-----|
| 145MUL | 3/4 x 4-1/2 | 2 Round Edge Craftsman Casing | N/S |
|--------|-------------|-------------------------------|-----|

Primed LDF

| Product | Dimensions | Material | Finish | Lengths available |
|---------|----------------|----------|--------|-------------------|
| 1098LDF | 11/16 x 1-1/2 | E2E | N/S | 16' |
| 1099LDF | 11/16 x 2-1/2 | E2E | N/S | 16' |
| 1100LDF | 11/16 x 3-1/2 | E2E | N/S | 16' |
| 1101LDF | 11/16 x 5-1/2 | E2E | N/S | 16' |
| 1102LDF | 1-1/4 x 5-1/2 | E2E | S | 16' |
| 1103LDF | 11/16 x 7-1/4 | E2E | N/S | 16' |
| 1104LDF | 1-1/4 x 7-1/4 | E2E | N/S | 16' |
| 1105LDF | 11/16 x 6-1/2 | E2E | S | 16' |
| 1106LDF | 11/16 x 11-1/4 | E2E | N/S | 16' |
| 1107LDF | 1-1/4 x 11-1/4 | E2E | N/S | 16' |
| 1108LDF | 1-1/16 x 3-1/2 | E2S | N/S | 16' |

Primed MUL (Ultralight)

| Product | Dimensions | Material | Finish | Lengths available |
|---------|----------------|----------|--------|-------------------|
| 1098MUL | 11/16 x 1-1/2 | E2E | S | 16' |
| 1099MUL | 11/16 x 2-1/2 | E2E | S | 16' |
| 1100MUL | 11/16 x 3-1/2 | E2E | S | 16' |
| 1101MUL | 11/16 x 5-1/2 | E2E | S | 16' |
| 1103MUL | 11/16 x 7-1/4 | E2E | S | 16' |
| 1105MUL | 11/16 x 6-1/2 | E2E | S | 16' |
| 1107MUL | 1-1/4 x 11-1/4 | E2E | S | 16' |
| 1108MUL | 1-1/16 x 3-1/2 | E2S | S | 16' |



MDF Shelving

(items are approximate scale only)

✦ lengths available: 10' & 16'



Unprimed - Bullnose Edge Shelving

| | | | |
|-----------------|----------------|-----|-----|
| 11MDF-BN | 11/16 x 11-1/4 | 16' | N/S |
| 12MDF-BN | 11/16 x 15-1/4 | 16' | S |
| 16MDF-BN | 11/16 x 15-1/4 | 16' | N |



Unprimed - Flat Edge Shelving

| | | | |
|----------------|----------------|------------|---|
| 11MDF-F | 11/16 x 11-1/4 | 16' | N |
| 16MDF-F | 11/16 x 15-1/4 | 16' | N |
| 13MDF-F | 11/16 x 23-1/4 | 16' | S |
| 30MDF-F | 11/16 x 30-1/2 | 10' or 16' | N |

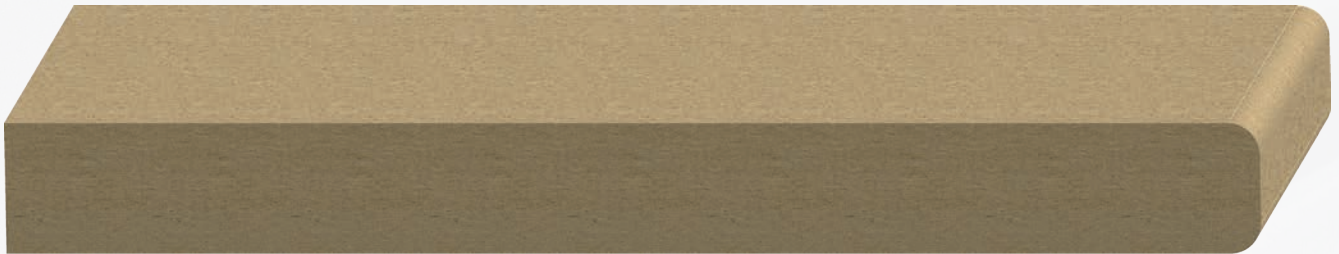

Unprimed - 2 Eased Edge Shelving

| | | | |
|-----------------|----------------|-----|---|
| 11MDF-2E | 11/16 x 11-1/4 | 16' | S |
| 12MDF-2E | 11/16 x 15-1/4 | 16' | S |

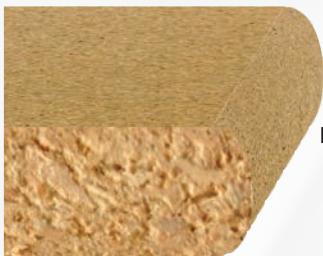

BN (Bullnose Face) N/S

Bullnosed Particle Board Shelving with Taped Edge

| | | | | | |
|-------------|--------------|---|----------------|--------------|---|
| 11PB | 5/8 x 11-1/4 | S | 11PB-BN | 3/4 x 11-1/4 | N |
| 12PB | 5/8 x 15-1/4 | S | 16PB-BN | 3/4 x 15-1/4 | N |
| 13PB | 5/8 x 23-1/4 | S | 24PB-BN | 3/4 x 23-1/4 | N |
| 16PB | 3/4 x 11-1/4 | S | | | |
| 17PB | 3/4 x 15-1/4 | S | | | |
| 18PB | 3/4 x 23-1/4 | S | | | |

(items are approximate scale only)

Interior Door Jambs

lengths available: 7' & 17'



| INTERIOR DOOR JAMBS | | | |
|-------------------------------|------------|---------|------------|
| | Primed MDF | | |
| SIZE | 6/8 | 8/0 | 17' LINEAL |
| 3-9/16 <i>N/S</i> | N/A | N/A | N/A |
| 4-9/16 <i>N/S</i> | 4916MI6 | 4916MI8 | 4916MIL |
| 4-13/16 <i>N/S</i> (4-3/4) | 434MI6 | 434MI8 | 434MIL |
| 5-1/4 <i>N/S</i> | 514MI6 | 514MI8 | 514MIL |
| 6-9/16 <i>N/S</i> | 6916MI6 | 6916MI8 | 6916MIL |
| 7-1/4 <i>N/S</i> | 714MI6 | 714MI8 | 714MIL |

Kerfing for bullnose is available on all jamb sizes and species and custom size odd wall widths available upon request.

Interior Door Jamb Specs

- ☞ 1 1/16" Thick
- ☞ Lineal - 17' = MDF
- ☞ Dado depth is 3/8"
- ☞ 5 pair per bundle

NOR CAL / CENTRAL CAL / AZ SPECS

- ☞ 6/8 = 81" Below Dado
- ☞ 8/0 = 97" Below Dado

SO CAL / SO NV SPECS

- ☞ 6/8 = 80-5/8" Below Dado
- ☞ 8/0 = 96-5/8" Below Dado



Big Ideas



VG Doug Fir & Redwood

STRONG AND DURABLE INSIDE OR OUT



VG Doug Fir is identified by its beautiful up and down vertical grains and red tones. VG Doug Fir can be clear coated (see above picture), stained or painted and is a great choice for homes with a craftsman, contemporary or rustic style.

Redwood's rot resistant properties make it ideal for exterior applications. Durable and said to be resistive to certain wood eating mites, Redwood is high in moisture and may darken over time. Redwood, maintained over time, looks best with paint or stain.



section contents

| | |
|--------------------------------------|----------|
| Astragal | 265 |
| Base & Base Shoe..... | 259 |
| Brick Mould | 269 |
| Bullnose Stepping | 266 |
| Casing..... | 257 |
| Corner Mold | 271 |
| Cove | 271 |
| Crown..... | 262 |
| Door Stop Header | 259 |
| Exterior Door Frames..... | 270 |
| Exterior Molds | 272 |
| Full Round..... | 269 |
| Gutter Mould..... | 272 |
| Handrail | 275 |
| Interior Door Jambs | 270 |
| Lattice | 271 |
| Ovolo Sticking..... | 264 |
| Panel Cap | 264 |
| Quarter Round | 271 |
| S4S..... | 266, 271 |
| Shingle Mould | 273 |
| Standard Frame for 1-3/4" Doors..... | 270 |
| Stool | 266 |
| Stucco Mold | 269 |
| T&G Flooring..... | 266 |
| Wainscot..... | 264 |
| Watertable | 273 |
| Wiggle Mould..... | 274 |
| Window Sill | 274 |

VG Doug Fir & Redwood

I/E

DESIGN STYLES

TRADITIONAL | RUSTIC | CRAFTSMAN | CONTEMPORARY

**JANKA
HARDNESS**
(POUNDS-FORCE)

660/450

CUT LIST

Determining How Much You Need

- 1 Measure the room at the height or length where each moulding goes to determine the number and the length of the pieces you'll need.
- 2 VG Doug Fir & Redwood moulding is available in 3' to 16' lengths, with some profiles available in 20'. Add your footage and multiply that number by 1.1. The result is the total footage needed plus ten percent for waste. Perform this step for each type of moulding, base, chair rail and crown, separately.
- 3 When ordering casing for doors, order 7' or 8' lengths for 6/8 doors and 9' or 10' lengths for 8/0 doors.
- 4 Most door heads are cut from random lineal footage. Always cut the longest pieces first: door legs, window legs, long window heads and sills, and then door heads.
- 5 The most important tool when working with moulding is **patience**. Remember the old adage, measure twice and cut once. Never try to rush trim work.
- 6 Lengths ordered may not always be available. Always verify availability when ordering.

ALWAYS TEST TO MAKE SURE YOUR MEASURING TOOLS ARE ACCURATE. IF YOU ARE WORKING WITH A HELPER, TAKE A MEASUREMENT WITH ONE TOOL WHILE YOUR HELPER MEASURES WITH ANOTHER AND COMPARE YOUR RESULTS.

FINISHING

REDWOOD

Sand lightly before finishing to remove dirt, hammer marks or other blemishes. Remove grease spots with a solvent such as mineral spirits or turpentine prior to sanding.

If nails are countersunk, nail holes can be filled with putty (if a paint or heavy-bodied stain is to be used), or with a non-oily filler (if a natural or light stain finish is planned). Wood fillers are available in a variety of tones, and fillers can be tinted with pigments to match the color of the wood. After filling, sand flat and dust the surface before finishing.

Finish with Clear Lacquer, Alkyd Resin & Polyurethane Varnishes, Pigmented Finishes, Wax (except kitchen and bathroom) or Alkyd Resin Sealers & Danish Oil (except bathroom).

DOUG FIR

Attach 100-grit sandpaper to a hand-sanding block. Stroke the surface of the wood, using short strokes until the sandpaper produces dust with a slightly coarse texture. Sand forward 4 inches and backward 3 inches. Keep moving forward in a single line with the woodgrain. When you reach the end of the wood, start another row overlapping the first line by 1 inch.

Dust off the wood with a soft cloth. You want a dull surface without any shiny spots when finished. The dull appearance means you have sufficiently opened the pores on the wood.

Dip a folded cotton cloth into an open can of stain. Wipe the surface of the wood with the wet cloth until the wood is consistently wet with stain.

Wipe the stain off with a dry, cotton cloth. Vigorously wipe the wood, using circular motions. When the wood looks dry, wipe it down one more time, using strokes parallel to the grain of the wood. Allow the stain to dry according to the manufacture's instructions. Allow oil stain to dry for at least 72 hours.

HELPFUL HINTS

- ❖ **Cope all inside corners** for baseboard, chair rail, and crown moulding.
- ❖ **When mitering wide mouldings**, and for all exterior trim work, use biscuits or dominoes to reinforce miters.
- ❖ **CHECK the moisture content of all wood moulding:** for interior trim, the MC should be 8-10%; for exterior trim the MC should be 12-14%. For every 4% change in MC, wood moves 1%.
- ❖ Exterior trim: use **'splitless' siding nails**—they have blunt tips and prevent wood from splitting.
- ❖ **Pre-drill:** for any nails driven closer than 3/4" to the edge of a board.
- ❖ **For painted trim:** caulk over any nails that are overdriven—countersunk too deep.
- ❖ **Last mouldings to be installed:** base, shoe and quarter rounds.
- ❖ **Chair rails** can be installed 32" to 36" from the floor.
- ❖ Use Rosettes and Plinth blocks at the corners of windows and doors to **eliminate the mitering process**.
- ❖ **After installation is complete:** caulk and/or putty all gaps and nail holes.
- ❖ Use any brand of spray furniture polish on saw blade as a **lubricant for easier cutting**.



FOR BEST FINISH PERFORMANCE, INTERIOR WOOD SHOULD BE CLEAN AND DRY. FOLLOW FINISH MANUFACTURER'S APPLICATION INSTRUCTIONS. DO NOT MIX INCOMPATIBLE FINISHES. WORK IN A WELL-VENTILATED ROOM.



2-1/4" to 3-1/4" Casing

lengths available: 6' thru 16'

(items are approximate scale only)

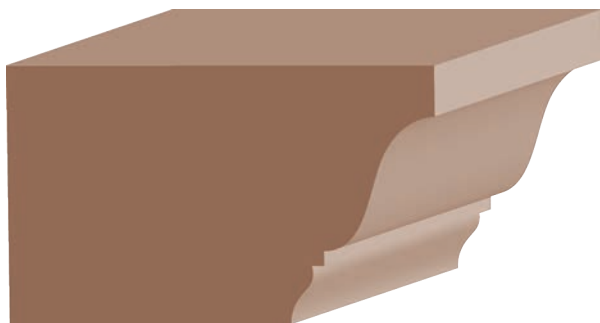

HC150VG 1-5/16 x 2-1/4 VG Fir Door Header Cap N/S



120VG 9/16 x 2-1/4 VG Fir 2 Round Edge Casing N/S

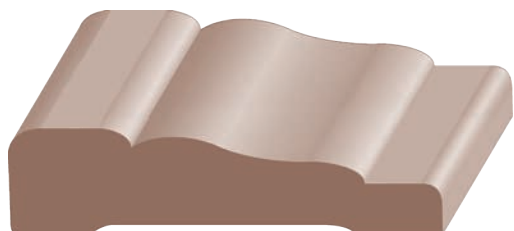

141VG 5/8 x 2-1/4 VG Fir Moulded Casing N

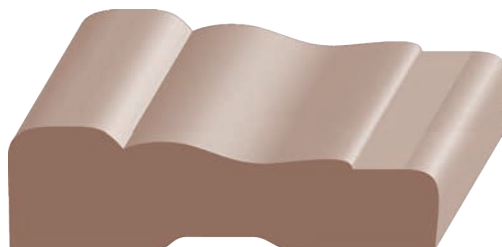

152VG 11/16 x 2-1/4 VG Fir Colonial/#356 Casing N/S

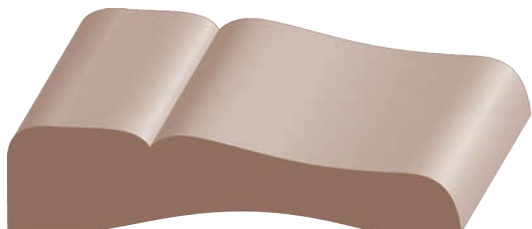

108VG 5/8 x 2-1/2 VG Fir #711 Casing S



114VG-3 5/16 x 3-1/4 VG Fir 2 Eased Edge Mullion Casing N/S



172VG-3 11/16 x 3-1/4 VG Fir Contemporary Casing N/S

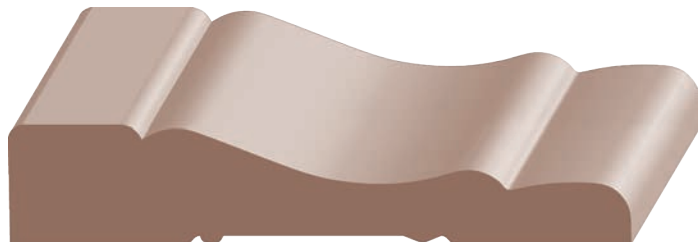

176VG 5/8 x 3-1/4 VG Fir Moulded Casing N/S

3-1/2" to 5-1/2" Casing

(items are approximate scale only)

lengths available: 6' thru 16'



139VG 11/16 x 3-1/2 VG Fir 2 Round Edge Casing *N/S*

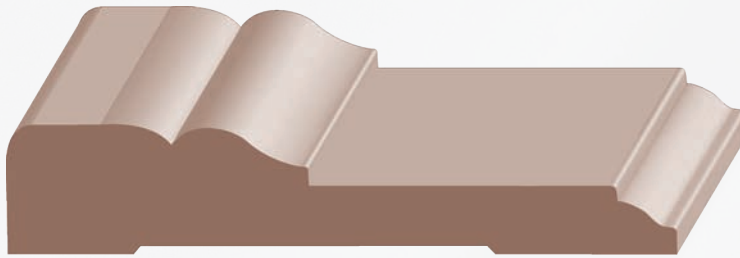

156VG 11/16 x 3-1/2 VG Fir Shasta Casing *N*

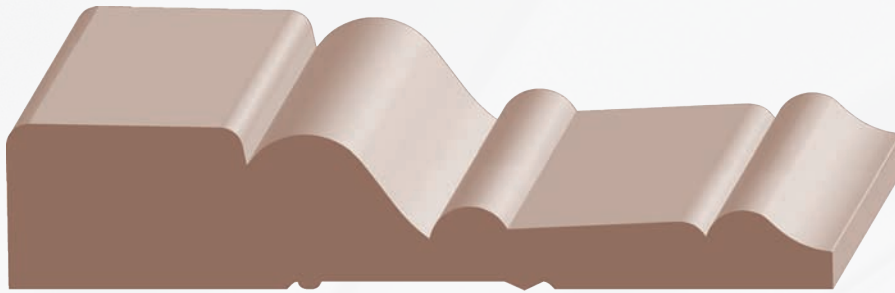

140VG 13/16 x 4-1/2 VG Fir Tuscany Casing *N*



114VG-5 5/16 x 5-1/2 VG Fir 2 Eased Edge Mullion Casing *N/S*

(items are approximate scale only)

Door Stop Header

lengths available: 6' thru 16'

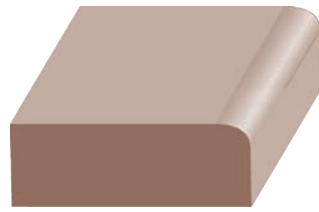

201VG 7/16 x 1-1/4
VG Fir 1 Round Edge Stop **N**



209VG 1/2 x 1-1/2
VG Fir 1 Round Edge Stop **N/S**

2-1/4" to 3-1/4" Base & Base Shoe

lengths available: 6' thru 16'

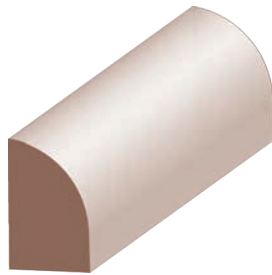

300BVG 7/16 x 11/16
VG Fir Base Shoe **N/S**

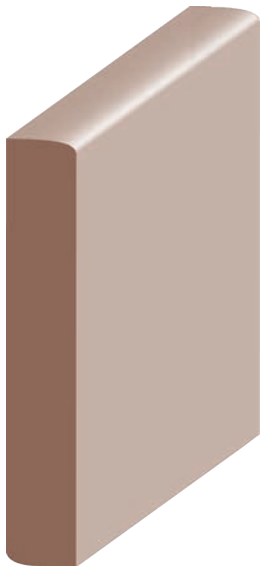

R304VG-2 3/8 x 2-1/4
VG Fir Reversible Base **N/S**



310VG 1/2 x 2-1/2
VG Fir #711 Base **S**

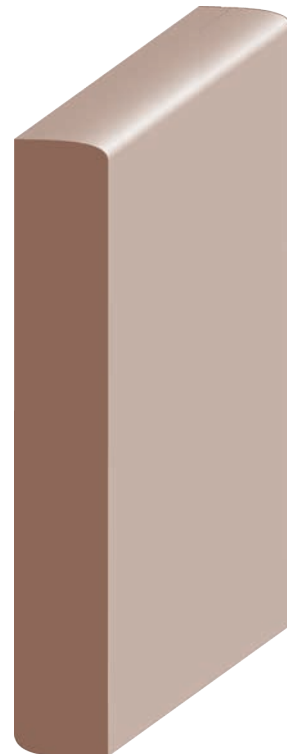

R306VG-3 1/2 x 3-1/4
VG Fir Reversible Base **N/S**



3-1/4" to 4-1/2" Base

lengths available: 7' and 17'

(items are approximate scale only)

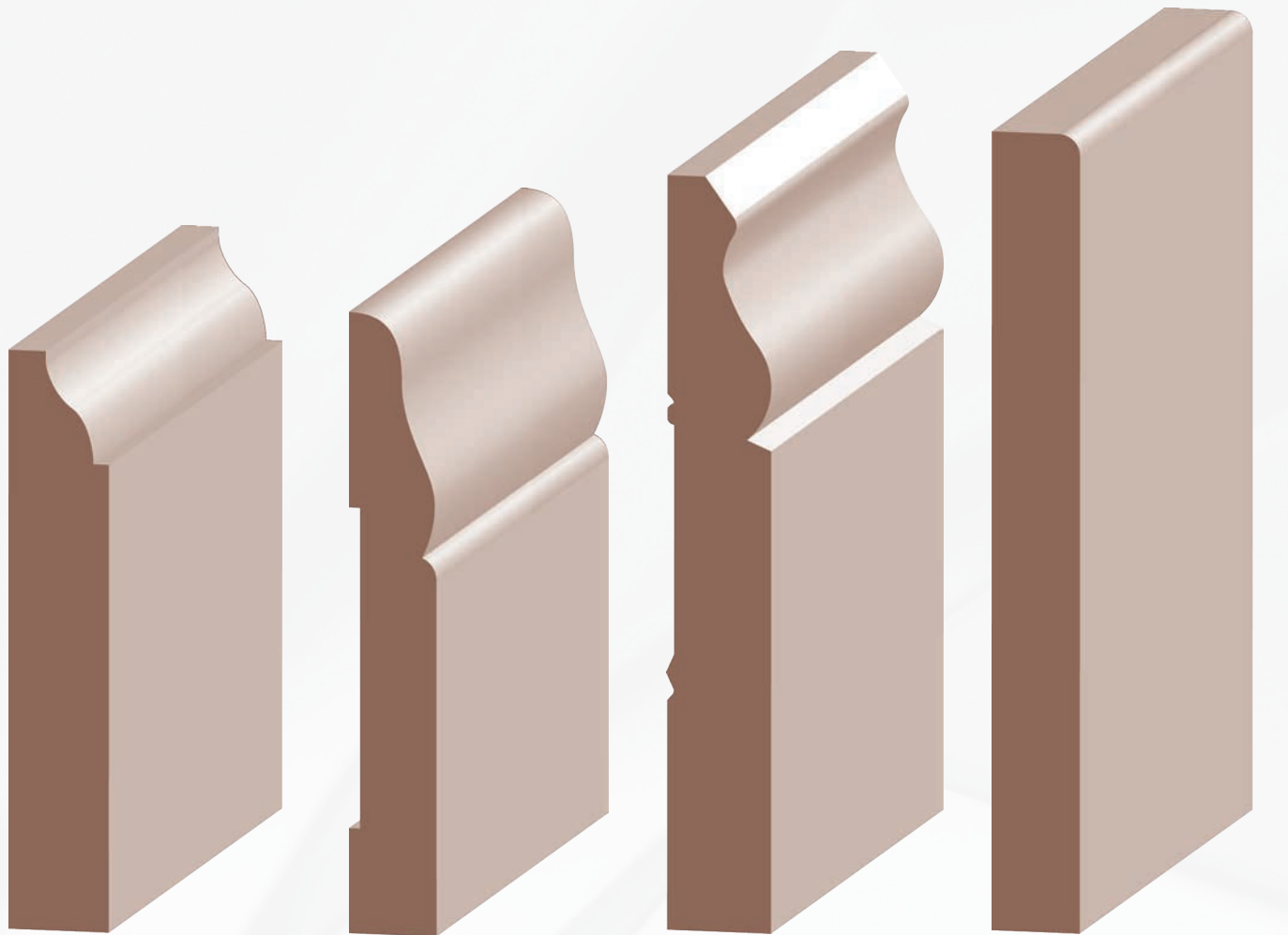

314VG-3 9/16 x 3-1/4
 VG Fir
 Coronado/#623 Base *N/S*

311VG 1/2 x 3-1/2
 VG Fir #711 Base *S*

328VG-4 1/2 x 4-1/2
 VG Fir
 Colonial Base *N/S*

387VG-4 1/2 x 4-1/2
 VG Fir 1 Eased Edge
 Craftsman Base *N/S*



(items are approximate scale only)

5-1/4" to 7-1/4" Base

lengths available: 6' thru 16'

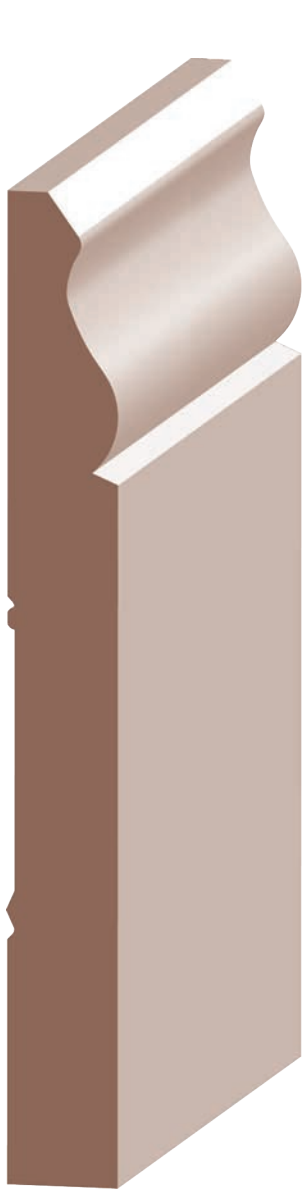

328VG-5 1/2 x 5-1/4
VG Fir
Colonial Base *N/S*

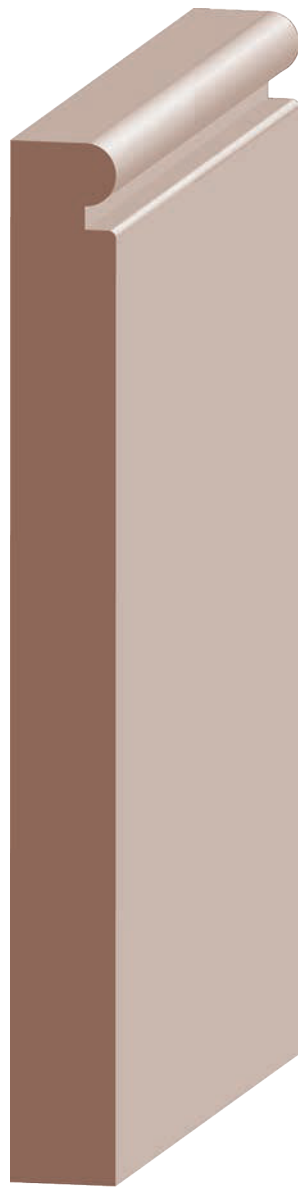

372VG-5 1/2 x 5-1/2
VG Fir
Contemporary Base *N/S*

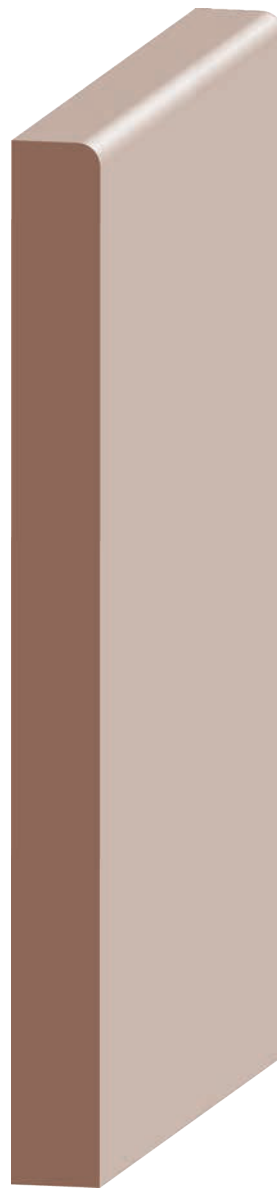

387VG-5 1/2 x 5-1/2
VG Fir 1 Eased Edge
Craftsman Base *N/S*

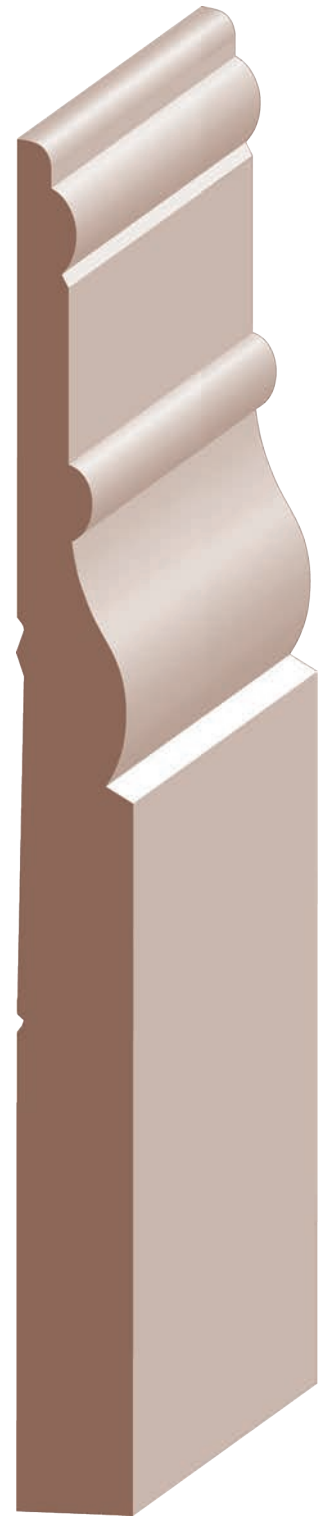

375VG-7 11/16 x 7-1/4
VG Fir
Tuscany Base *N*



4-1/4" to 4-5/8" Crown

lengths available: 7' and 17'

(items are approximate scale only)

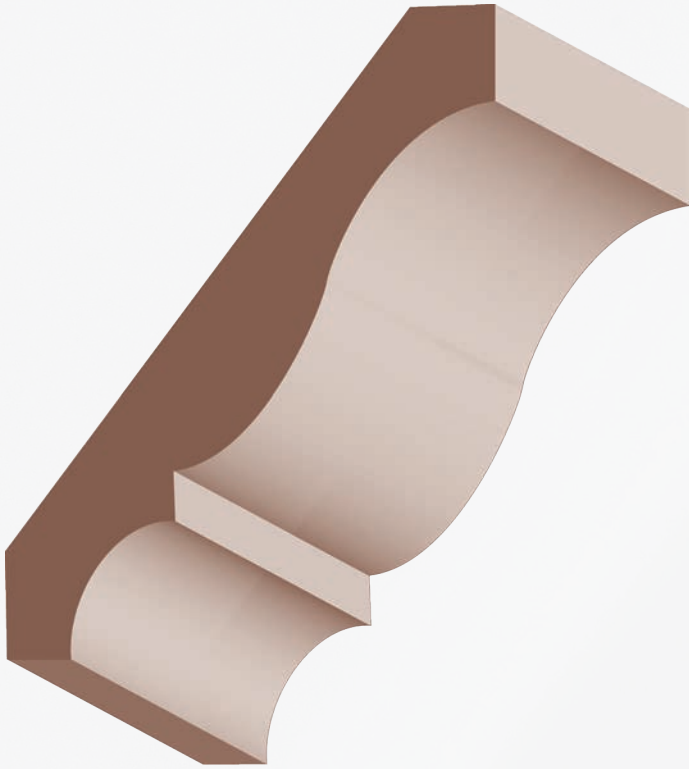

406VG 9/16 x 4-1/4
VG Fir Colonial Crown N/S

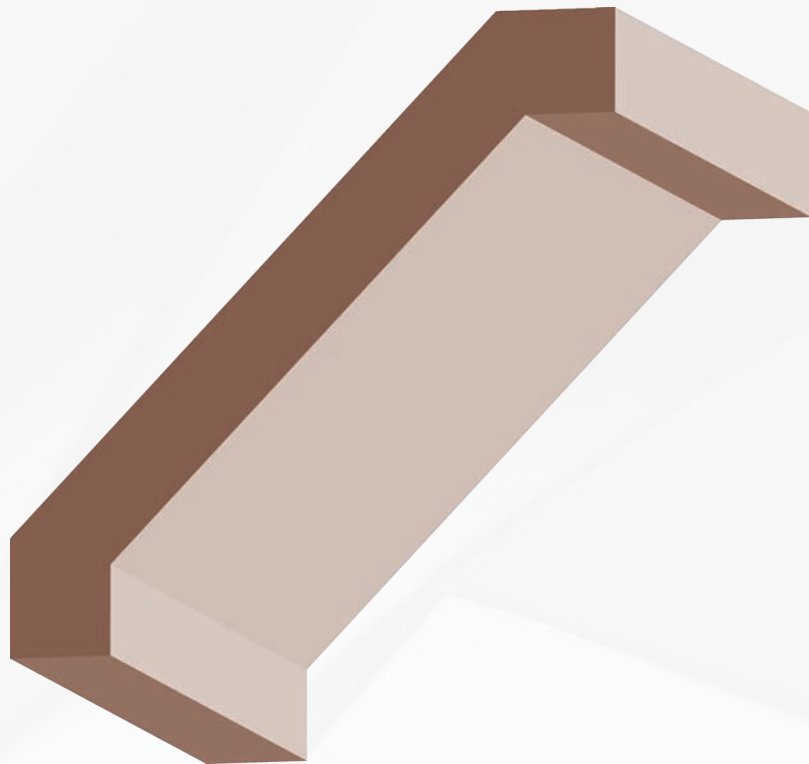

460VG 11/16 x 4-5/8
VG Fir Craftsman Crown N/S



(items are approximate scale only)

5-1/4" to 7-1/4" Crown

lengths available: 7' and 17'

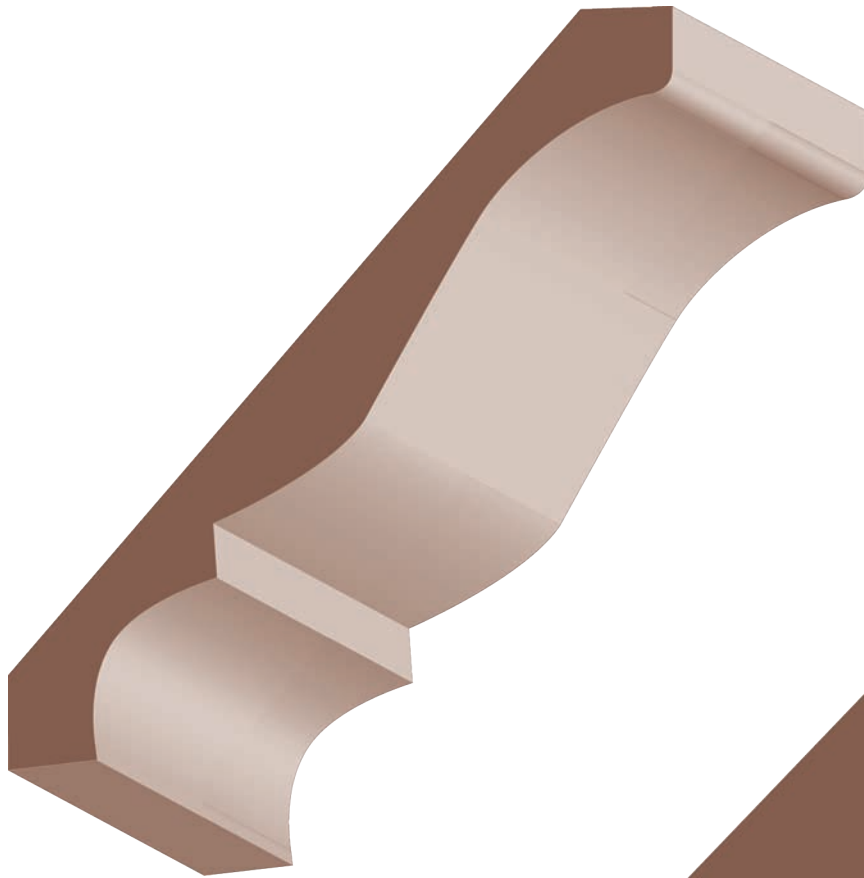

414VG 9/16 x 5-1/4
VG Fir Colonial Crown N/S

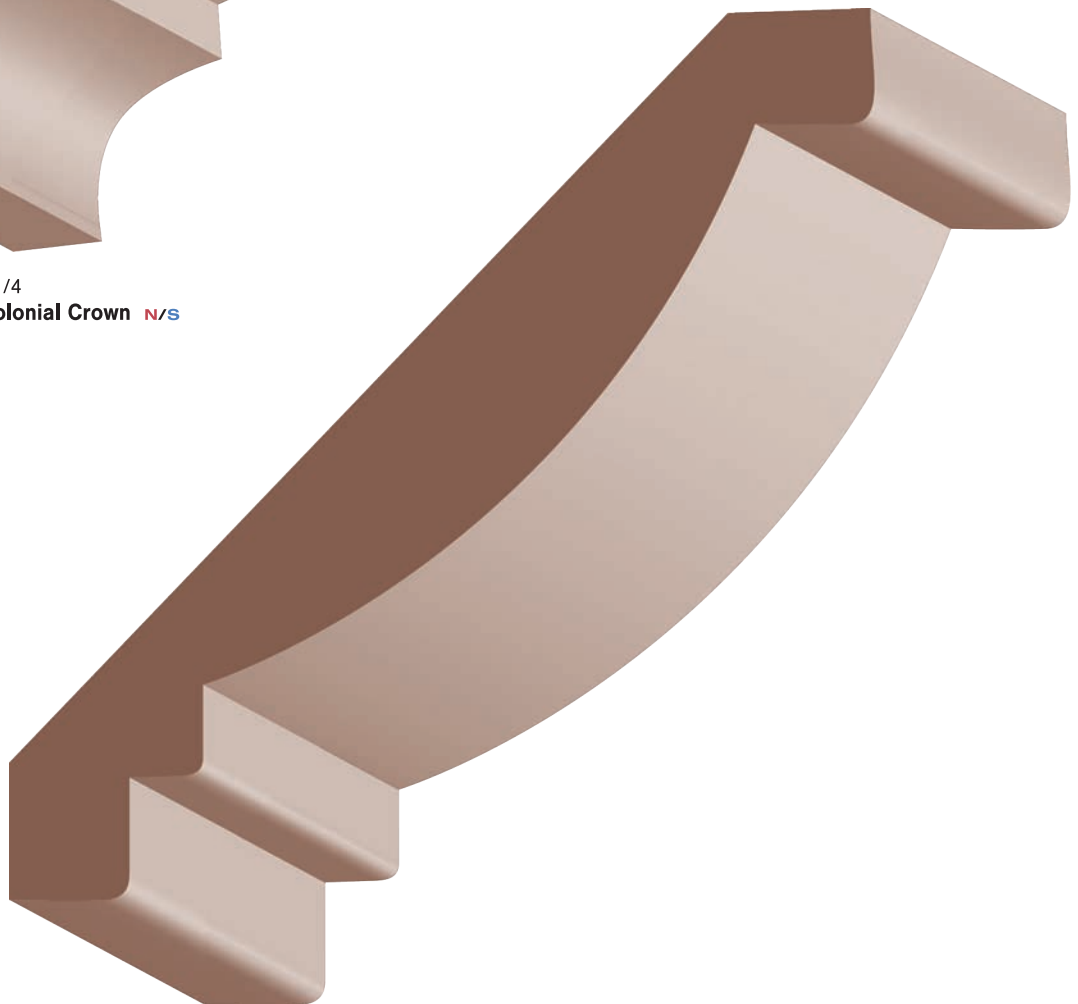

462VG 1 x 7-1/4 VG Fir Tahoe Crown N/S



Quarter Round / Cove / Ovolo Sticking

(items are approximate scale only)

lengths available: 7' and 17'



504VG 11/16 x 11/16
VG Fir Quarter Round *N/S*

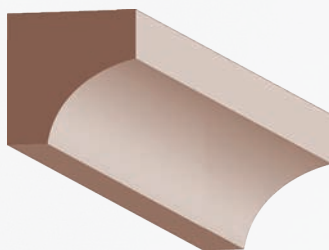

523VG 11/16 x 11/16
VG Fir Cove *N/S*

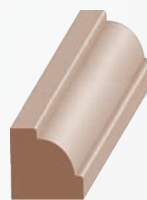

599VG 3/8 x 3/8
VG Fir Ovolo Sticking *N/S*

Panel Cap / Wainscot

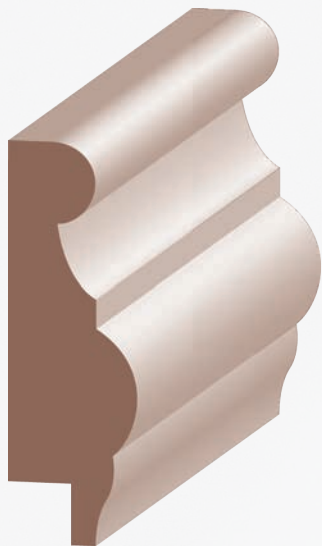

620VG 11/16 x 2-1/8
VG Fir Coronado Wainscot Cap *N/S*
[with 3/8" Rab't]

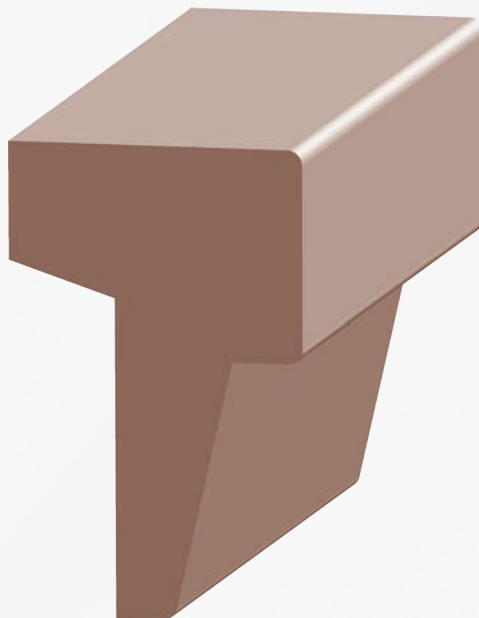

623VG 1-9/16 x 2-1/2
VG Fir Craftsman Cap *N/S*
[with 9/16" Rab't]



R2000VG 3/8 x 3-1/4 VG Fir Reversible Beaded/Flat T&G Wainscot *N/S*

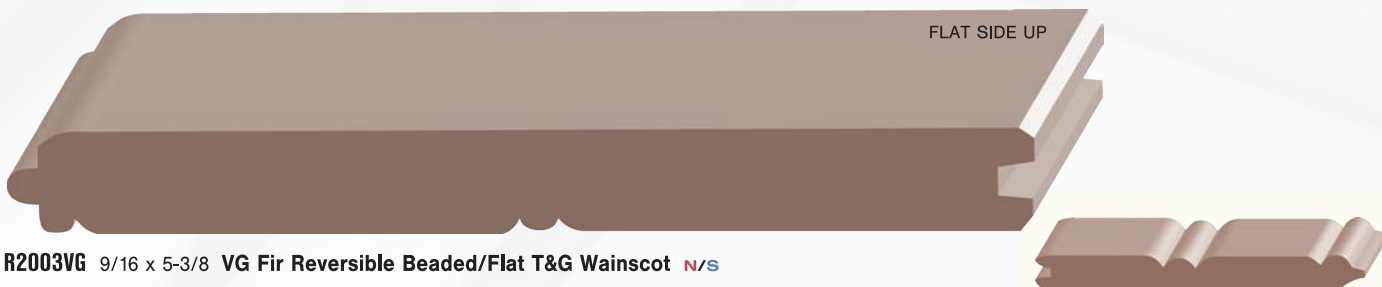

R2003VG 9/16 x 5-3/8 VG Fir Reversible Beaded/Flat T&G Wainscot *N/S*

Astragal

lengths available: 7' and 17'

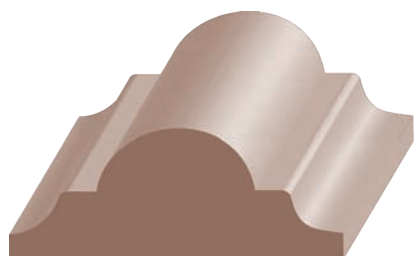

646VG 1 1/16 x 1-5/8 **VG Fir Flat Astragal/Panel Mold** **N**

660VG 3/4 x 1-5/8 **VG Fir Flat Astragal/Panel Mold** **S**

lengths available: 7' and 8' only

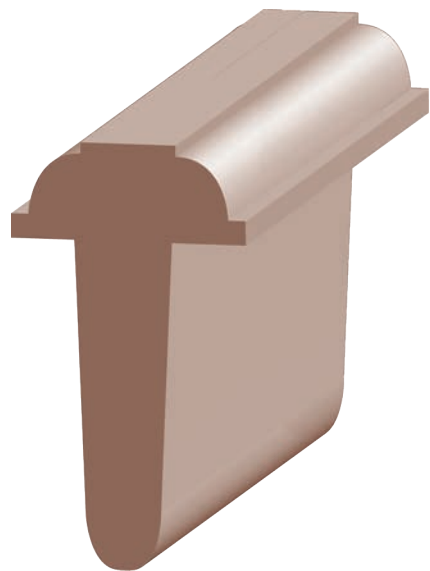

662VG 1-1/4 x 2
VG Fir T-Astragal for 1-3/8" Door **N/S**

lengths available: 7' and 8' only

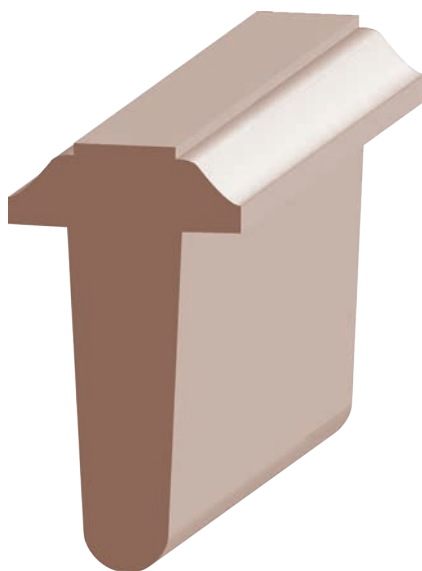

661VG 1-1/4 x 2-1/4
VG Fir T-Astragal for 1-3/4" Door **N/S**

lengths available: 7', 8' and 12' only

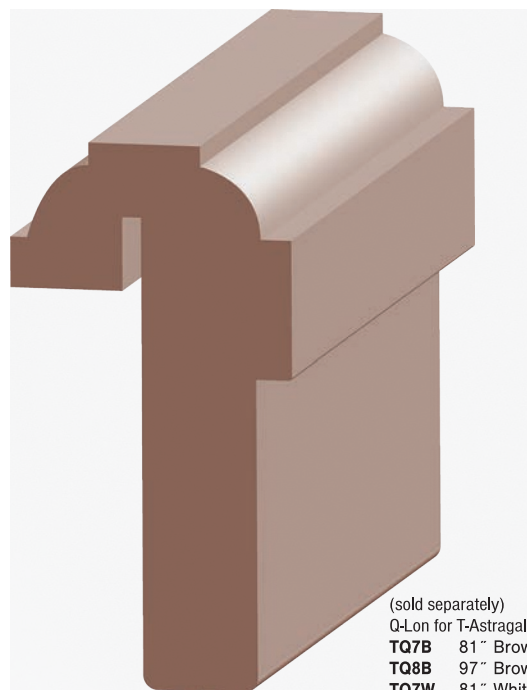

(sold separately)
Q-Lon for T-Astragal
TQ7B 81" Brown
TQ8B 97" Brown
TQ7W 81" White
TQ7W 81" White

663VG 1-1/2 x 2-7/8
VG Fir T-Astragal w/Weather Strip Kerf for 1-3/4" Door **N/S**
(Q-Lon sold separately)

663BVG 1-5/8 x 3
Thick VG Fir T-Astragal w/Weather Strip Kerf for 1-3/4" Door **S**

lengths available: 7', 8' and 12' only

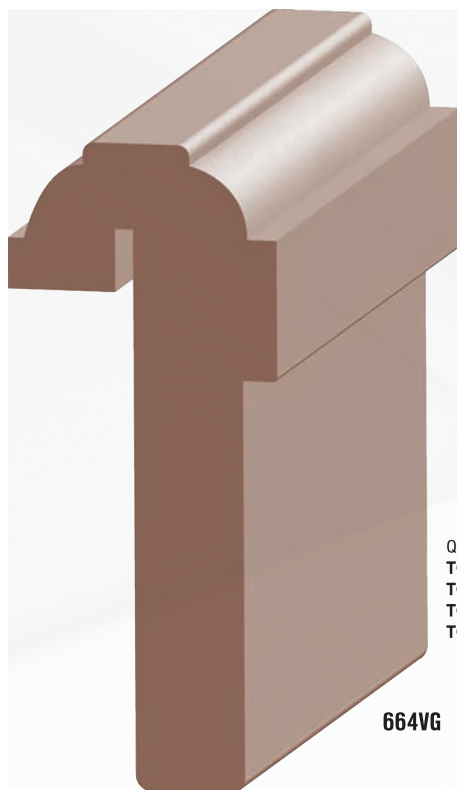

Q-Lon for T-Astragal
TQ7B 81" Brown
TQ8B 97" Brown
TQ7W 81" White
TQ7W 81" White

664VG 1-1/2 x 3-3/8
VG Fir T-Astragal w/Weather Strip Kerf for 2-1/4" Door **N/S**
(Q-Lon sold separately)

lengths available: 7', 8' and 12' only

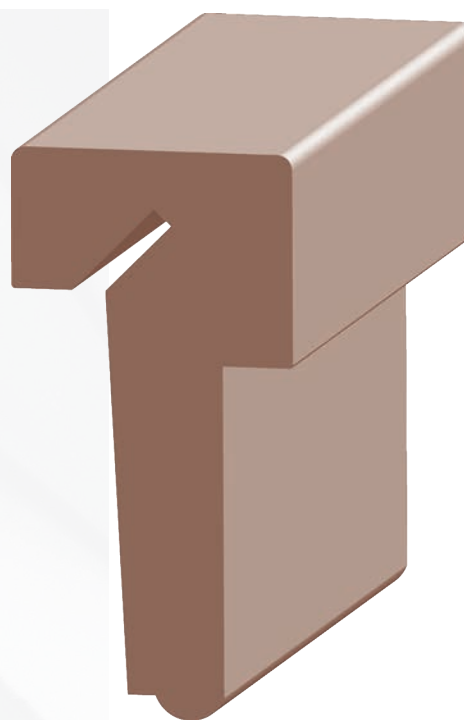

667VG 1-1/2 x 3-1/8
VG Fir Contemporary T-Astragal w/Weather Strip Kerf for 1-3/4" Door **N/S**
(Q-Lon sold separately)

lengths available: 7' and 8' only

Stool

(items are approximate scale only)

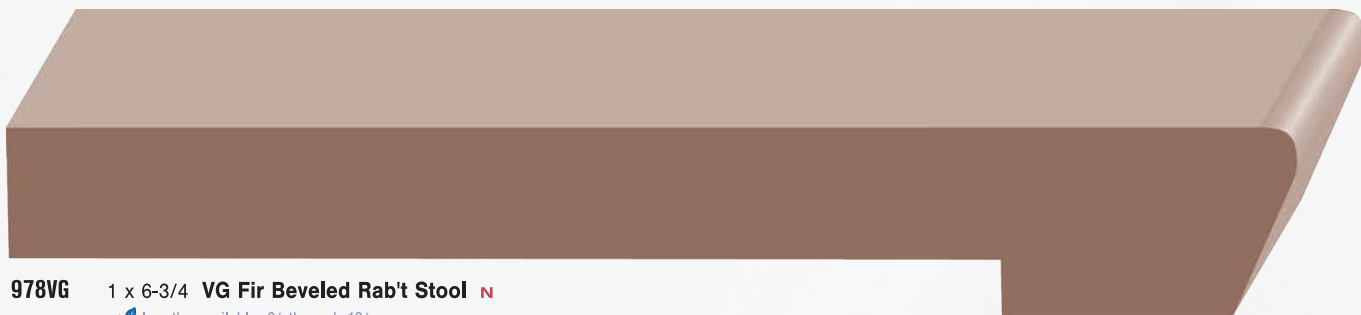

978VG 1 x 6-3/4 **VG Fir Beveled Rab't Stool** **N**
 lengths available: 6' through 16'

Bullnose Stepping and VG T&G Flooring



890VG 1-1/4 x 11-1/4 **VG Fir Bullnose Stepping** **N**
 (5/4 x 12)
 lengths available: 6' through 16'



FL1X4VG 3/4 x 3-1/2 **VG Fir T&G Flooring** **N**

S4S



DUTCHVG 1-1/4 x 3-1/2 **VG Fir S4S** **S**

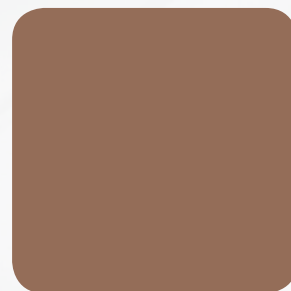

717VG 1-1/2 x 1-1/2 (2x2) **VG Doug Fir S4S** **N**
725VG 3-1/2 x 3-1/2 (4x4) **VG Doug Fir S4S** **N**

| | | | | | | | | | |
|--------------|--------------|--------|------------------------|------------|--------------|----------------|--------|------------------------|----------|
| 713VG | 3/4 x 1-1/2 | (1x2) | VG Doug Fir S4S | N | 755VG | 1-1/2 x 3-1/2 | (2x4) | VG Doug Fir S4S | N |
| 714VG | 3/4 x 2-1/2 | (1x3) | VG Doug Fir S4S | N | 756VG | 1-1/2 x 5-1/2 | (2x6) | VG Doug Fir S4S | N |
| 715VG | 3/4 x 3-1/2 | (1x4) | VG Doug Fir S4S | N/S | 757VG | 1-1/2 x 7-1/4 | (2x8) | VG Doug Fir S4S | N |
| 750VG | 3/4 x 5-1/2 | (1x6) | VG Doug Fir S4S | N/S | 759VG | 1-1/2 x 9-1/4 | (2x10) | VG Doug Fir S4S | N |
| 751VG | 3/4 x 7-1/4 | (1x8) | VG Doug Fir S4S | N/S | 758VG | 1-1/2 x 11-1/4 | (2x12) | VG Doug Fir S4S | N |
| 752VG | 3/4 x 9-1/4 | (1x10) | VG Doug Fir S4S | N/S | | | | | |
| 753VG | 3/4 x 11-1/4 | (1x12) | VG Doug Fir S4S | N/S | | | | | |

(items are approximate scale only)

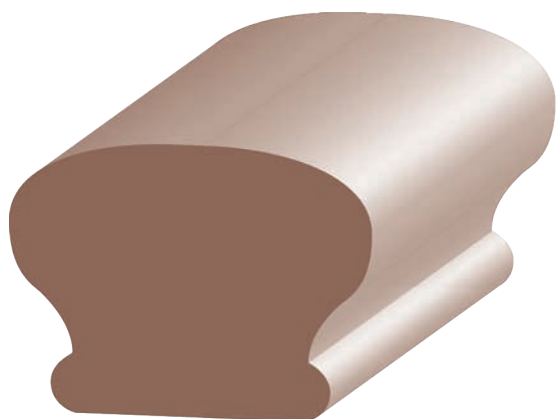

F955 1-7/16 x 1-15/16 **Doug Fir Mushroom Handrail** **N**
F956 1-7/16 x 2-3/8 **Doug Fir Mushroom Handrail** **N**
F956FJ 1-7/16 x 2-3/8 **FJ Doug Fir Mushroom Handrail** **N**
 + Trimbacks (lengths other than 16')

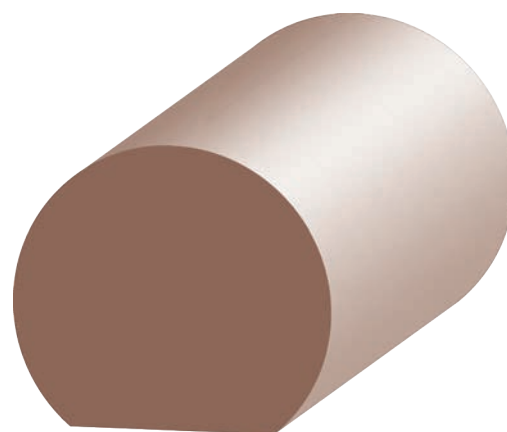

F951FJ 1-1/2 x 1-11/16 **FJ Doug Fir Flat Bottom Handrail** **N**
 + Trimbacks (lengths other than 16')

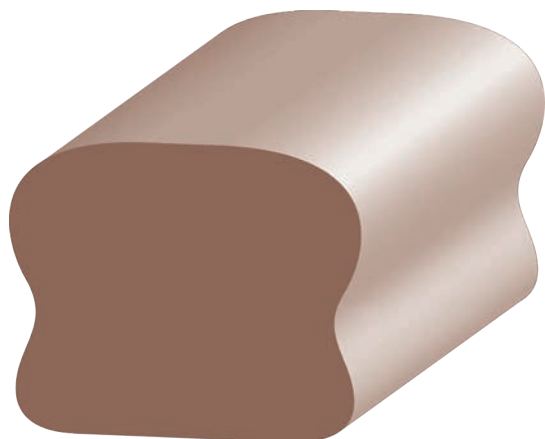

F926 1-1/2 x 1-7/8 **Doug Fir Small Handrail** **S**

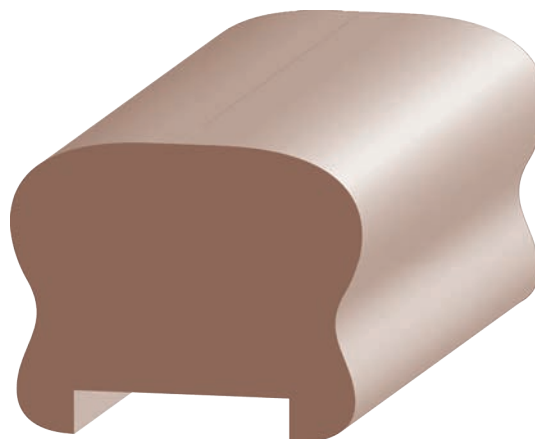

F926PL 1-1/2 x 1-7/8 **Doug Fir Small Handrail with 1/4 x 1-1/4 Plow** **S**

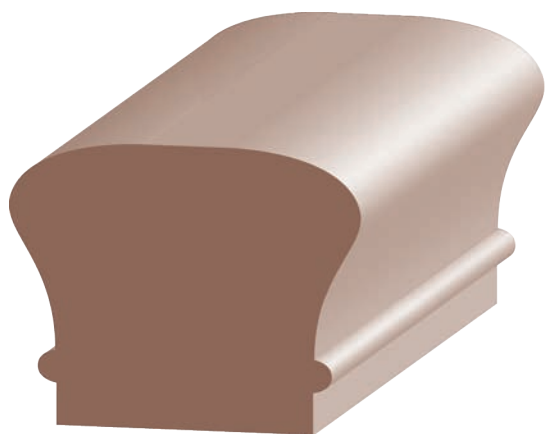

F932 1-1/2 x 1-7/8 **Doug Fir Small #6010 Handrail** **S**

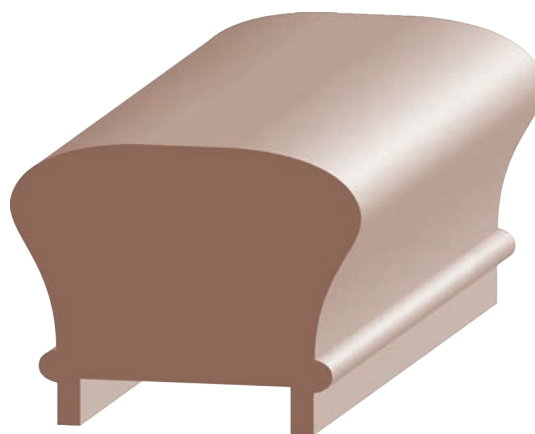

F932PL 1-1/2 x 1-7/8 **Doug Fir Small #6010 Handrail with 1/4 x 1-1/8 Plow** **S**

Handrail

(items are approximate scale only)

✂ lengths available: 8' through 20'

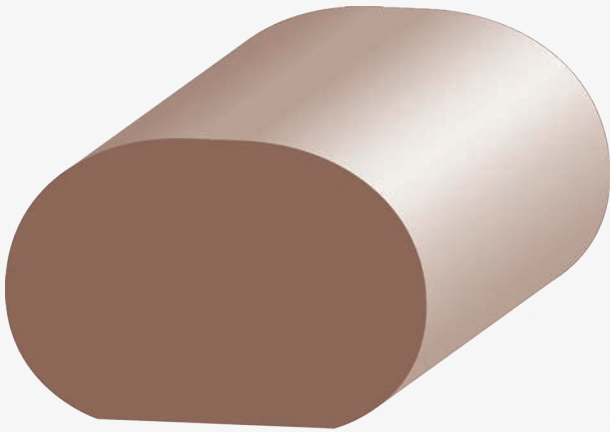

F927 1-1/2 x 2-1/4 Doug Fir Oval Handrail **s**

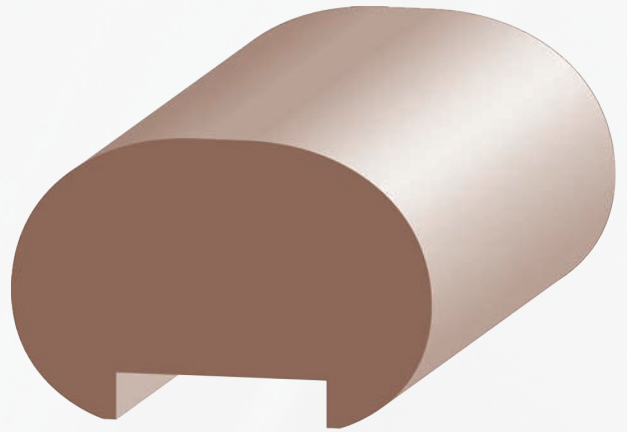

F927PL 1-1/2 x 2-1/4 Doug Fir Oval Handrail **s**
with 1/4 x 1-1/8 Plow

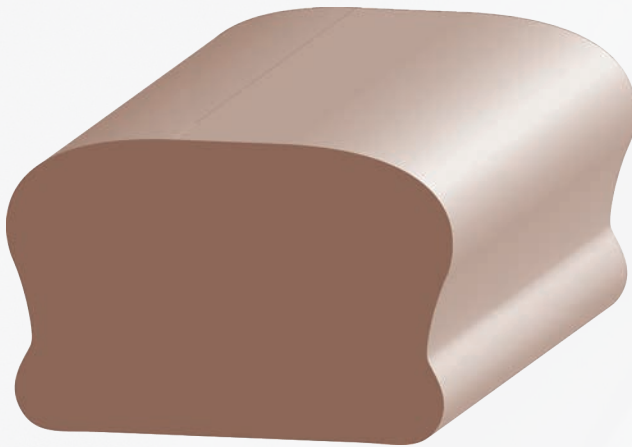

F925 1-1/2 x 2-3/8 Doug Fir Standard Handrail **s**

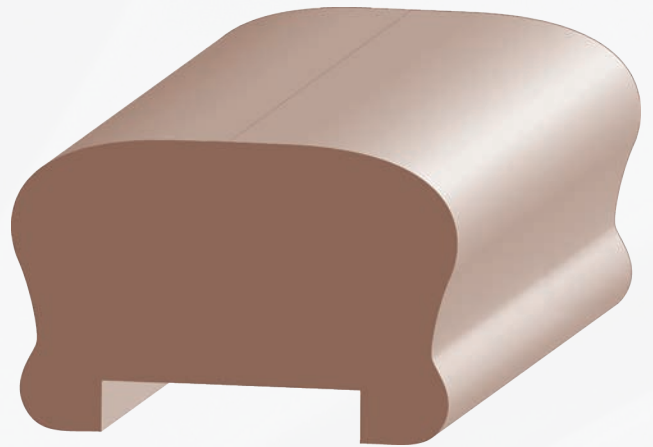

F925PL 1-1/2 x 2-3/8 Doug Fir Standard Handrail **s**
with 1/4 x 1-1/4 Plow

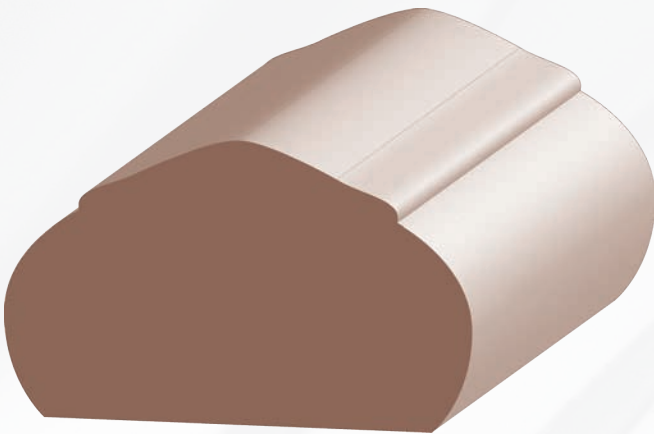

F928 1-1/2 x 2-1/2 Doug Fir 'B' Mushroom Handrail **s**

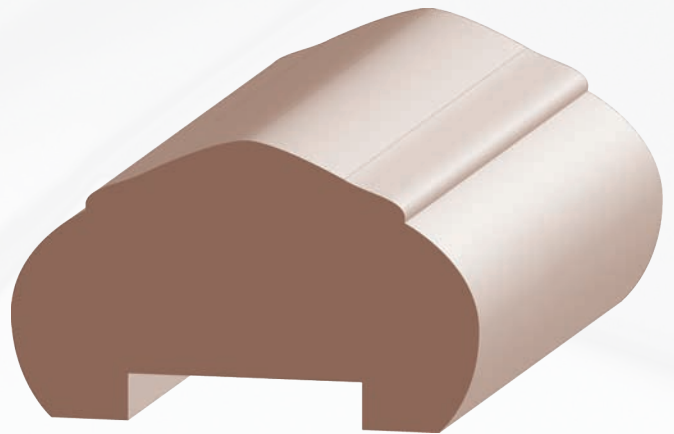

F928PL 1-1/2 x 2-1/2 Doug Fir 'B' Mushroom Handrail **s**
with 1/4 x 1-1/4 Plow



(items are approximate scale only)

Brick Mould / Stucco Mold

 lengths available: 6' thru 20'

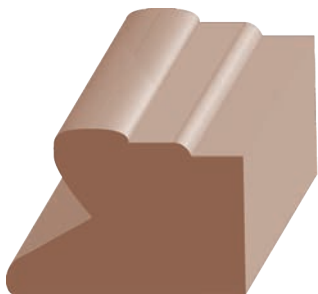

953VG 7/8 x 1-1/4 VG Fir Stucco Mold **S**



833VG 11/16 x 1-1/2 VG Fir Stucco Mold **N**

 lengths available: 7' and 17'

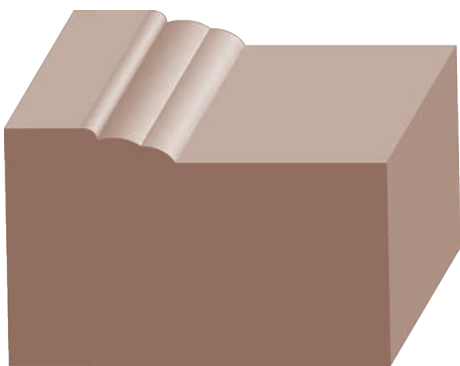

612AVG 1-1/4 x 2 VG Fir #180 Eastern Brick Mould **N/S**
without Stucco Key

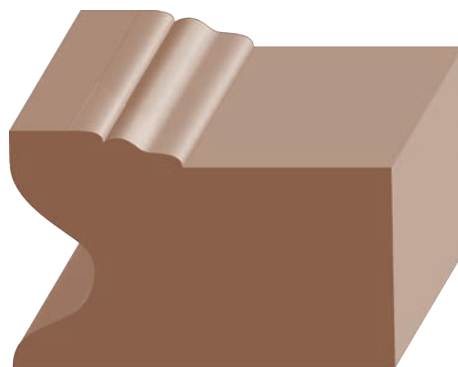

612BVG 1-1/4 x 2 VG Fir #180 Eastern Brick Mould **N/S**
with Stucco Key

Full Round

 lengths available: solid fir 6'-20' / fj fir 16'+ trimbacks

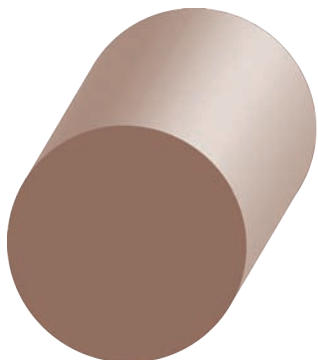

Doug Fir Full Round
F800 3/4 **S**
F806 1/2 **S**
F801 1 **S**

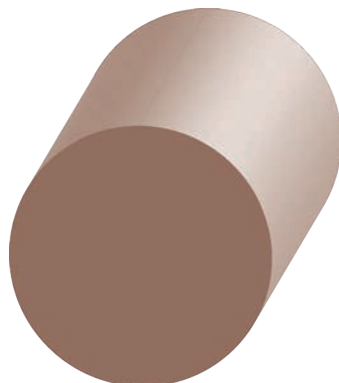

Doug Fir Full Round
F802 1-1/4 **N/S**
F803 1-3/8 **N/S**
F804 1-5/8 **N/S**
F805 1-7/8 **N/S**

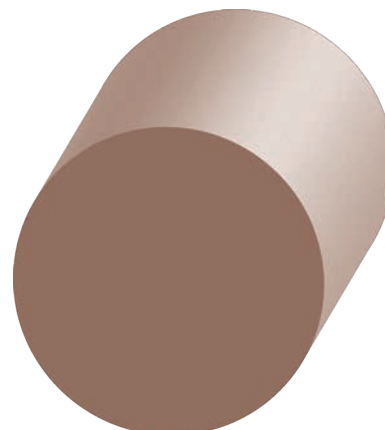

FJ Doug Fir Full Round
F802FJ 1-1/4 **N**
F804FJ 1-1/2 **N**



Weatherstrip Kerfed Exterior Door Frames

lineal pairs available in 6/8 and 8/0; all 6" through 16"

(items are approximate scale only)

| ENGINEERED EXTERIOR DOOR FRAMES | | | | |
|--|--------------------------|----------------------|----------------------|-----------------------|
| Weatherstrip Kerfed for 1/2" x 2-1/8" Door Rab't. | | | | |
| SELECT CORRECT PART NUMBER BASED ON SPECIES/LOCATION | | | | |
| SIZE | SPECIE | 6/8 PRS. | 8/0 PRS. | LINEAL (SOLID VG FIR) |
| 4-1/8" | Flat Grain Fir VG Fir | 418WFGE6 418WVGE6 | 418WFGE8 418WVGE8 | 418WFGL 418WVGL |
| 4-5/8" | Flat Grain Fir VG Fir | 458WFGE6 458WVGE6 | 458WFGE8 458WVGE8 | 458DFGL 458WVGL |
| 5-1/4" | Flat Grain Fir VG Fir | 514WFGE6 514WVGE6 | 514WFGE8 514WVGE8 | 514WFGL 514WVGL |
| 6-1/8" | Flat Grain Fir | 618WFGE6 | 618WFGE8 | 618WFGL |
| 6-9/16" | Flat Grain Fir | 618WFGE6 | 618WFGE8 | 618WFGL |
| 6-5/8" | VG Fir | 658WVGE6 | 658WVGE8 | 658WVGL |
| 7-1/4" | Flat Grain Fir VG Fir | 714WFGE6 714WVGE6 | 714WFGE8 714WVGE8 | 714WFGL 714WVGL |

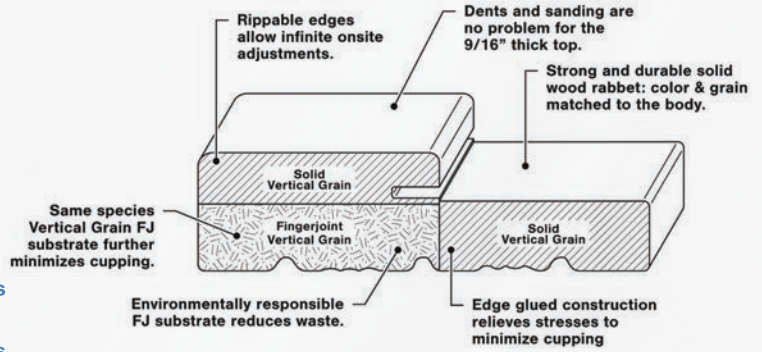

1-3/4" doors only (Engineered in both Flat Grain and Vertical Fir Grain)

VG Fir Exterior Door Frame Specs

- N/S
- 1-1/4" Thick
- 6/8 = 82-1/2" Below Dado
- 8/0 = 98-1/2" Below Dado
- No Screen Rabbet

Flat Grain Fir Exterior

- S
- Single End Dado (Except on Lineal)
- 3 Pair Per Bundle
- Kerfing for Bullnose is Available
- Custom Widths Available
- Ripping Strip up to 1"

| ENGINEERED EXTERIOR DOOR FRAMES | | | | |
|---|--------------------------|--------------------|--------------------|-----------------------|
| Standard for 1/2" x 1-13/16" Door Rab't. | | | | |
| SELECT CORRECT PART NUMBER BASED ON SPECIE/LOCATION | | | | |
| SIZE | SPECIE | 6/8 PRS. | 8/0 PRS. | LINEAL (SOLID VG FIR) |
| 4-1/8" | Flat Grain Fir VG Fir | 418FGE6 418VGE6 | 418FGE8 418VGE8 | 418FGL 418VGL |
| 4-1/2" | Flat Grain Fir | 412FGE6 | 412FGE8 | 412FGL |
| 4-5/8" | VG Fir | 458VGE6 | 458VGE8 | 458VGL |
| 4-3/4" | Flat Grain Fir | 434FGE6 | 434FGE8 | 434FGL |
| 5-1/4" | Flat Grain Fir VG Fir | 514FGE6 514VGE6 | 514FGE8 514VGE8 | 514FGL 514VGL |
| 6-1/8" | Flat Grain Fir | 618FGE6 | 618FGE8 | 618FGL |
| 6-5/8" | Flat Grain Fir VG Fir | 658FGE6 658VGE6 | 658FGE8 658VGE8 | 658FGL 658VGL |
| 7-1/4" | Flat Grain Fir VG Fir | 714FGE6 714VGE6 | 714FGE8 714VGE8 | 714FGL 714VGL |

Standard Frame for 1-3/4" Doors

Engineered in both Flat Grain and Vertical Fir Grain. *Lineal is solid (not engineered).

lineal pairs available in 6/8 and 8/0; all 6" through 16"

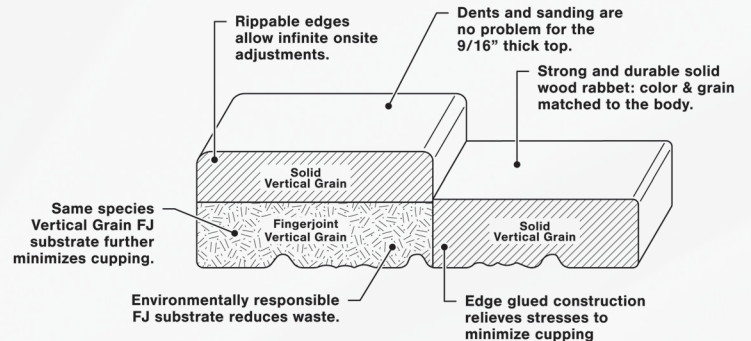

Interior Door Jambs

Engineered Vertical Grain Fir

lineal pairs available in 6/8 and 8/0; all 6" through 16"

| INTERIOR DOOR JAMBS | | | |
|------------------------|----------|----------|--------------|
| Engineered VG Doug Fir | | | |
| SIZE | 6/8 PRS. | 8/0 PRS. | RNDM. LINEAL |
| 3-9/16 | 3916FI6 | 3916FI8 | 3916FIL |
| 4-9/16 | 4916FI6 | 4916FI8 | 4916FIL |
| 4-13/16 (4-3/4) | 434FI6 | 434FI8 | 434FIL |
| 5-1/4 | 514FI6 | 514FI8 | 514FIL |
| 7-1/4 | 714FI6 | 714FI8 | 714FIL |
| 11-1/4 | 1114FI6 | 1114FI8 | 1114FIL |



Interior Door Jamb Specs

- 11/16" Thick
- NOR CAL/CENTRAL CA/AZ SO CAL/NEVADA
- 6/8 = 81" Below Dado N 6/8 = 805/8" Below Dado S
- 8/0 = 97" Below Dado N 8/0 = 96-5/8" Below Dado S
- Lineal - 5'-16"
- Random Lengths only available in most Solid Wood Species
- Dado depth is 3/8"
- Heads cut 3/4" over opening
- 5 pair per bundle

Kerfing for bullnose is available on all jamb sizes and species. Custom size odd wall widths available upon request.



(items are approximate scale only)

Corner Mold / Quarter Round / Cove

lengths available: 7' through 20'

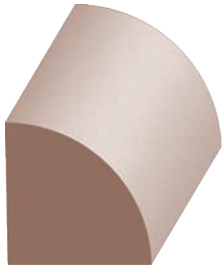

504R 3/4 x 3/4
Redwood Quarter Round N

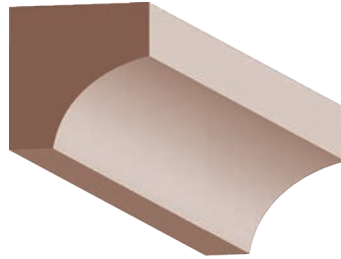

523R 3/4 x 3/4
Redwood Cove N

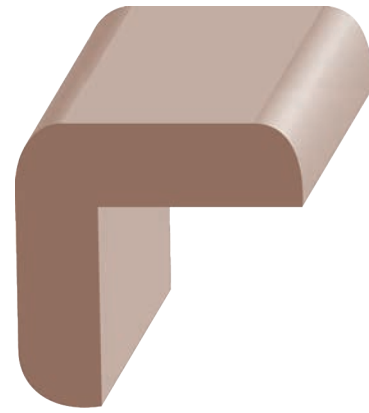

722R 1-1/2 x 1-1/2
Redwood Outside Corner Guard N

S4S / Lattice

lengths available: 7' through 20'

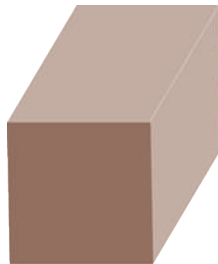

711R 3/4 x 3/4 **Redwood S4S** N



713R 3/8 x 2-1/2 **Redwood S1S2E Batten** N



742R 11/16 x 1-1/2 **Redwood E4E S4S** N



| | | | |
|-------------|-------------|------------------------|-----|
| 819R | 1/4 x 1-3/8 | Redwood Lattice | N |
| 820R | 1/4 x 1-1/4 | Redwood Lattice | S |
| 821R | 1/4 x 1-5/8 | Redwood Lattice | N/S |
| 822R | 1/4 x 2-1/2 | Redwood Lattice | S |
| 823R | 1/4 x 3-1/2 | Redwood Lattice | S |
| 830R | 1/4 x 5-1/2 | Redwood Lattice | S |



Redwood Exterior Molds

lengths available: 6' thru 20' solid redwood | 7' and 17' fj redwood

(items are approximate scale only)

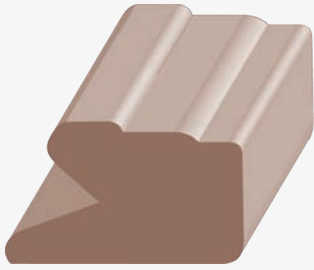

826R 3/4 x 1-1/4
Redwood Stucco Mold **S**

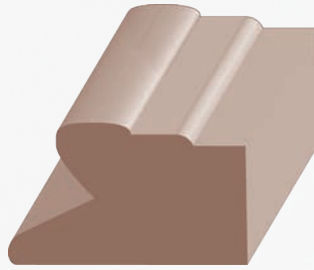

953RFJ 3/4 x 1-1/4
FJ Redwood Stucco Mold **S**



824R 1-3/8 x 1-3/8
Redwood Brick Mold **S**

826AR 7/8 x 1-1/2
Redwood Large Stucco Mold **S**



825R 7/8 x 1-5/8
Redwood Siding Mold **S**



833R 13/16 x 1-1/2
Redwood Stucco Mold **N**



PR842R 15/16 x 1-3/4
Primed Redwood
Step Siding Mold **N**

833RFJ 13/16 x 1-1/2
FJ Redwood Stucco Mold **N**

PR833RFJ 13/16 x 1-1/2
FJ Primed Redwood Stucco Mould **N**



PR844RFJ 1 x 2-5/8
Primed FJ Redwood
Stucco Mould **N**

Redwood Gutter Mould

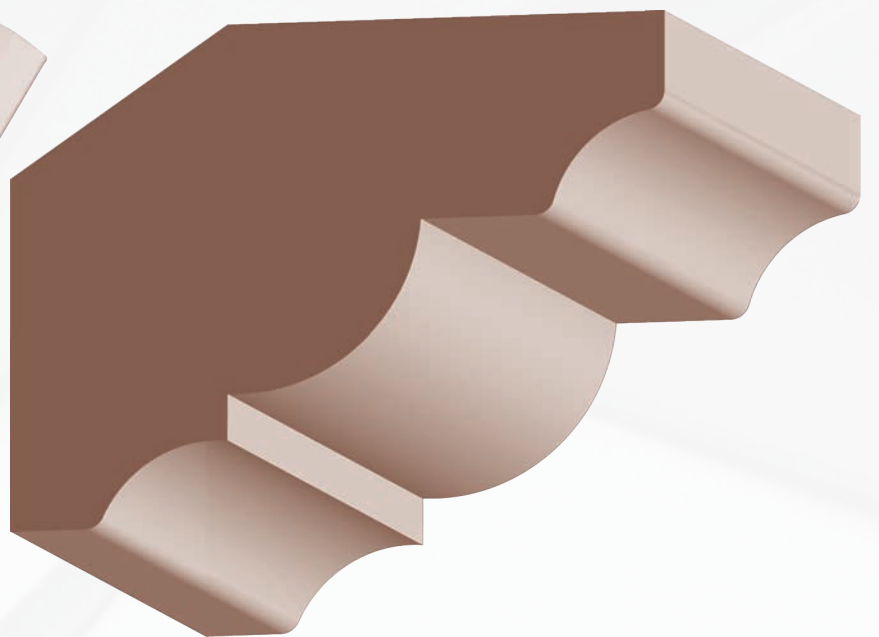

PR760RFJ 1-3/8 x 3-1/4
Primed FJ Redwood Gutter Mould **N**

(items are approximate scale only)

Redwood Shingle Mould

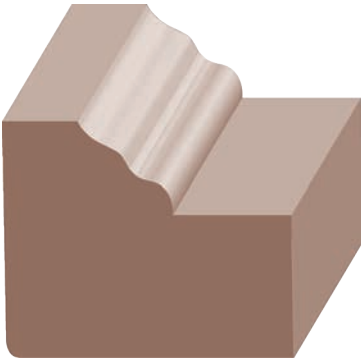

841R 1-1/4 x 1-1/2 **Redwood Brick Mold** **N**
PR841R 1-1/4 x 1-1/2 **Primed Redwood Brick Mold** **N**

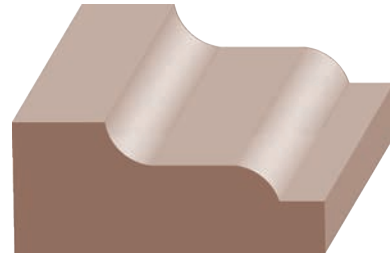

739R 11/16 x 1-5/8 **Redwood Shingle Mould** **N**
PR739R 11/16 x 1-5/8 **Primed Redwood Shingle Mould** **N**

Redwood Watertable

 lengths available: 6' thru 16'

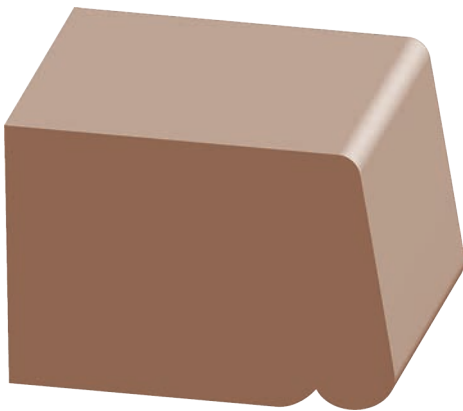

PR827R 1-7/16 x 1-11/16
Primed Redwood Watertable **N**



PR829R 1-7/16 x 3-1/4
Primed Redwood Watertable **N**

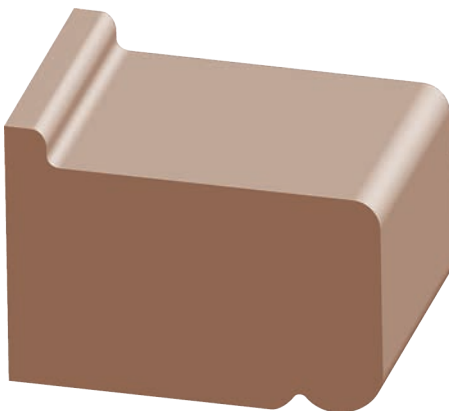

827WR 1-3/8 x 2
Redwood Water Table with Lip **S**

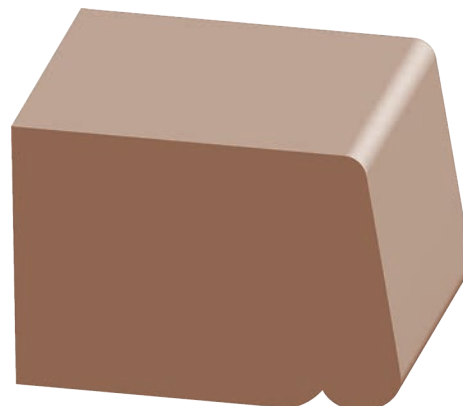

827R 1-7/16 x 2
Redwood Water Table with no Lip **S**

Redwood Window Sill

(items are approximate scale only)



- 8RS** 1-3/8 x 7-1/4 **Redwood Sill** N/S
- 10BRS** 1-3/8 x 8-7/8 **Redwood Sill** N
- 10RS** 1-3/8 x 9-1/4 **Redwood Sill** S



- 8RVS** 1-3/8 x 7-1/4 **Redwood Reversible Sill** N



- 8RSD** 1-3/8 x 7-1/4 **Redwood Sill w/Detail** S

Redwood Wiggle Mould

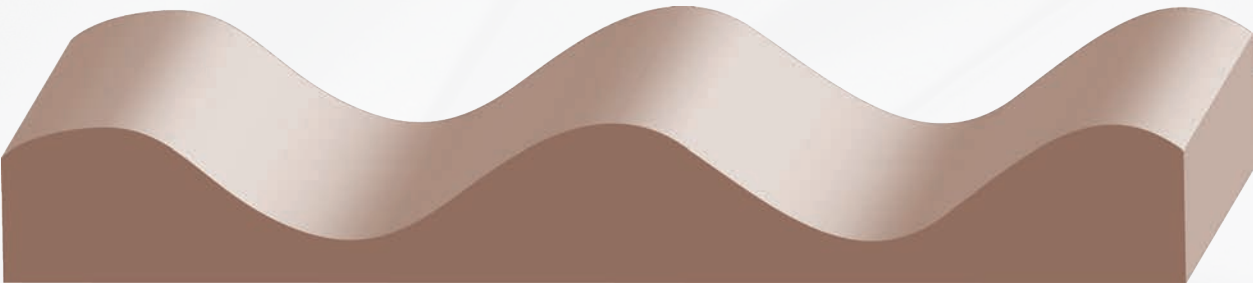

- 828TP** 3/4 x 1-5/8 **Treated Pine Corrugated Wiggle Mould w/Redwood Stain** N/S
✂ lengths Available: 8'

(items are approximate scale only)

Redwood Handrail

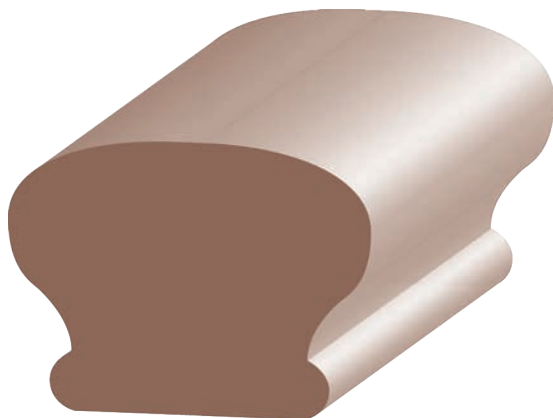

955R 1-7/16 x 1-15/16
Redwood Mushroom Handrail N

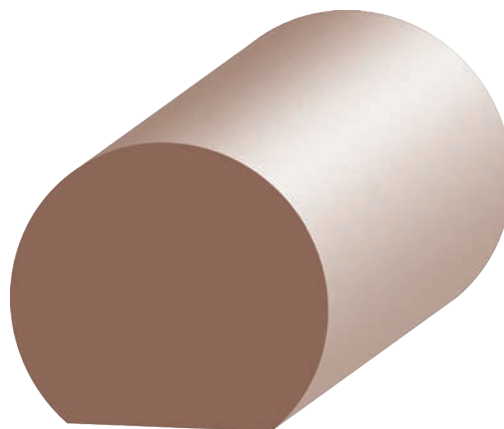

951R 1-1/2 x 1-11/16
Redwood Flat Bottom Handrail N



Big Ideas





American hardwoods are the environmentally friendly choice for today's modern home design. Our temperate U.S. forests grow nearly twice as much hardwood as we harvest each year. With far more hardwood growth than there is harvesting, American hardwoods, for moulding and millwork, are the definition of environmentally friendly, green and sustainable, now and for future generations. For more information, visit americanhardwood.org.



POPLAR



CHERRY



MAPLE



KNOTTY ALDER



OAK



MAHOGANY



SUPERIOR ALDER



WALNUT



section contents

| | |
|----------------------------------|-----|
| Astragal..... | 322 |
| Base and Base Shoe | 288 |
| Casing..... | 277 |
| Chair Rail..... | 319 |
| Cove | 314 |
| Crown..... | 299 |
| Dentil Lineal..... | 313 |
| Exterior Door Frames..... | 332 |
| Exterior Mold | 323 |
| Handrail | 324 |
| Header | 287 |
| Interior Jambs..... | 332 |
| Nose & Cove..... | 329 |
| Oak Threshold..... | 327 |
| Outside Corner Guard..... | 323 |
| Panel Mold & Cap | 315 |
| Quarter / Half / Full Round..... | 314 |
| Reducer | 331 |
| Ropes | 331 |
| S4S Boards | 331 |
| Screen & Pencil Molds | 314 |
| Sill | 328 |
| Stair Nosing | 330 |
| Stool | 330 |
| Stop | 288 |
| T&G Wainscot..... | 321 |

Hardwoods

DESIGN STYLES

ARTS & CRAFTS | MODERN | ART DECO

**JANKA
HARDNESS**
(POUNDS-FORCE)

950-3000

GREEN CHOICES

American hardwoods are the environmentally friendly choice for today's modern home design. Our temperate U.S. forests grow nearly twice as much hardwood as we harvest each year. This kind of sustainability is meeting today's needs, without compromising the ability of future generations to meet their needs. With far more hardwood growth than there is harvesting, American hardwoods for moulding and millwork are the definition of environmentally friendly, green and sustainable, now and for future generations. For more information, visit www.americanhardwood.org.

CHARACTERISTICS

In stock and available for immediate delivery, our hardwood species include oak, maple, cherry, mahogany, superior or knotty alder and poplar.

All hardwoods, with the exception of poplar, are stain grade and come in 5'-16' lengths – predominantly in 6'-12' lengths. Alder is available up to 10' lengths only.

Poplar :

Little to no grain with light and dark color fluctuations. A green hue is also common. High-end paintgrade product. Can be stained by a highly trained professional.

Oak :

Southern Oak is strong and durable with a beautiful grain that is easy to stain darker or redder. Generally available in 6'-12' lengths. Long lengths are rare.

Cherry & American Cherry :

Spectacular in both color and grain. The sapwood in American Cherry adds a white variation to it's pure red coloring. Cherry that's completely red is considered premium and is not typical of standard stock – it must be specially quoted when "all red" is required.

Mahogany :

Deep rich coloration from pale reddish to dark brown. Flecking is typical.

Maple

Light in color. May be stained or clear coated. Available in hard or soft Maple. Check stock for availability when one or the other is specifically required.

Alder :

Stylish and rustic. Most profiles are Superior Alder grade. Knotty Alder is denoted as: Part Number followed by KA. Standard Superior Alder is denoted as: Part Number followed by ALD. Knotty Alder is available at a reduced cost but is subject to large, sometimes open knots. Longest length available is 10' for both Superior and Knotty Alder.

HELPFUL HINTS

- * **Cope all inside corners** for baseboard, chair rail, and crown molding, unless installing MDF mouldings, and then it's best to miter all inside corners.
- * **Glue all miters and splices**—both sides/pieces of each joint, to control moisture content and to prevent stain from wicking into the endgrain and darkening the miters.
- * **Pre-assemble wide casing using miter clamps.** Without clamping pressure, glue joints will not reach the full strength of the glue.
- * **When mitering wide mouldings**, and for all exterior trim work, use biscuits or dominoes to reinforce miters.
- * **CHECK the moisture content of all wood moulding:** for interior trim, the MC should be 8-10%; for exterior trim the MC should be 12-14%. For every 4% change in MC, wood moves 1%.
- * Exterior trim: use '**splitless**' siding nails—they have blunt tips and prevent wood from splitting.
- * **Pre-drill:** for any nails driven closer than 3/4" to the edge of a board.
- * **For painted trim:** caulk over any nails that are overdriven—countersunk too deep.
- * **Last mouldings to be installed:** base, shoe and quarter rounds.
- * **Chair rails** can be installed 32" to 36" from the floor.
- * Use Rosettes and Plinth blocks at the corners of windows and doors to **eliminate the mitering process.**
- * **After installation is complete:** caulk and/or putty all gaps and nail holes.
- * Use any brand of spray furniture polish on saw blade as a **lubricant for easier cutting.**



MAPLE, PINE, SOME MAHOGANY AND BRAZILIAN CHERRY CAN ABSORB STAIN IN AN INCONSISTENT MANNER CAUSING BLOTCHINESS OR STREAKING. USING A CONDITIONER BEFORE STAINING WILL HELP THE WOOD APPEAR MORE CONSISTENT IN COLOR AND STAIN ABSORPTION.

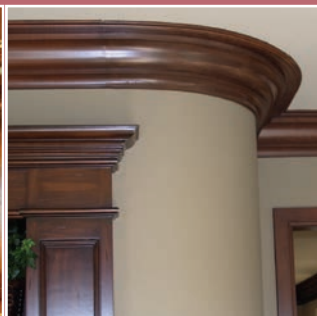

(items are approximate scale only)

1-1/4" to 2-1/4" Casing

lengths available: 6' thru 16'

AS ALL SPECIES
AS* ALL SPECIES EXCEPT KNOTTY ALDER

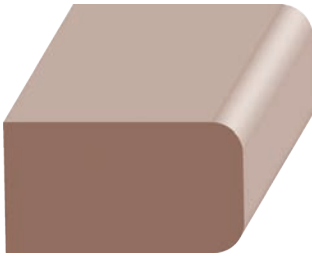

11/16 x 1-1/4 **2 Eased Edge Door Header**
970P Poplar **N**
970ALD Superior Alder **N**

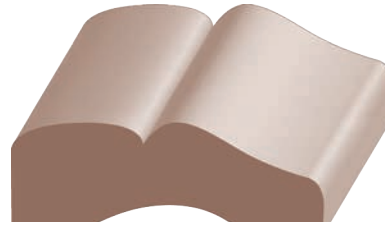

1/2 x 1-9/16 **#711 Casing**
107-0 Oak **S**

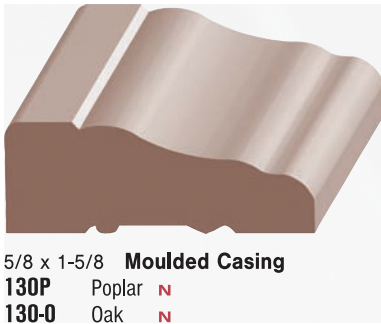

5/8 x 1-5/8 **Moulded Casing**
130P Poplar **N**
130-0 Oak **N**

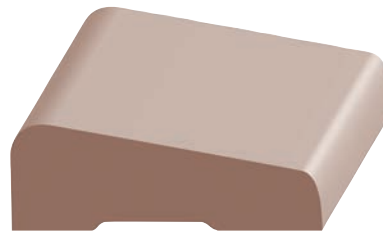

5/8 x 1-5/8 **Beveled/Streamline Casing**
102-0 Oak **N/S**

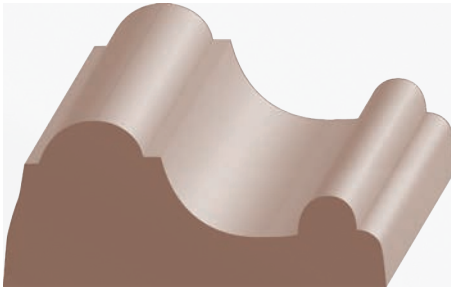

7/8 x 2 **Malibu Casing** **AS***
179P Poplar **S** | **179C** Cherry **S**
179-0 Oak **S** | **179MH** Mahogany **S**
179ALD Superior Alder **S** | **179MP** Maple **S**

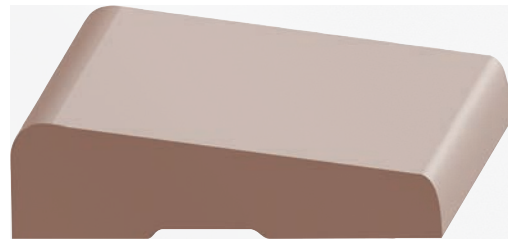

5/8 x 2-1/4 **Beveled Casing**
103-0 Oak **N**

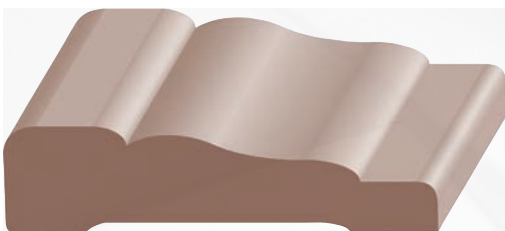

5/8 x 2-1/4 **Moulded Casing**
141P Poplar **N**
141-0 Oak **N**



9/16 x 2-1/4 **Colonial/#356 Casing**
152-0 Oak **N/S**
11/16 x 2-1/4 **Colonial/#356 Casing** **AS***
152P Poplar **N/S** | **152C** Cherry **N**
152B-0 Oak **N/S** | **152MH** Mahogany **N**
152ALD Superior Alder **N** | **152MP** Maple **N**
152KA Knotty Alder **N**



2-3/8" to 2-1/2" Casing

lengths available: 6' thru 16'

(items are approximate scale only)

AS
ALL SPECIES

AS*
ALL SPECIES
EXCEPT KNOTTY ALDER

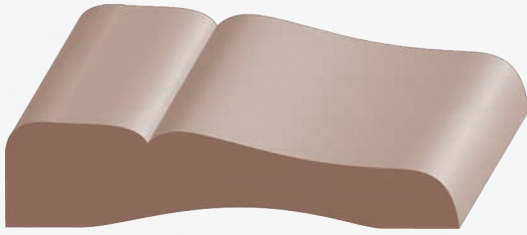

5/8 x 2-3/8 **#711 Casing**

| | | |
|---------------|----------------|----------|
| 108P | Poplar | S |
| 108-0 | Oak | S |
| 108ALD | Superior Alder | S |
| 108MH | Mahogany | S |

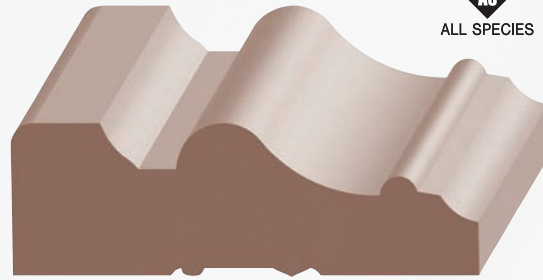

13/16 x 2-7/16 **Santa Fe/#275 Casing**

| | | | | | |
|---------------|----------------|------------|--------------|----------|------------|
| 167P | Poplar | N/S | 167C | Cherry | N/S |
| 167-0 | Oak | N | 167MH | Mahogany | N/S |
| 167ALD | Superior Alder | N | 167MP | Maple | N/S |

AS*

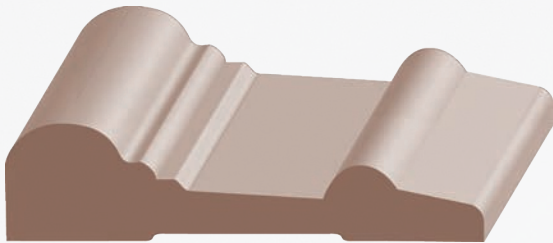

5/8 x 2-7/16 **Universal Casing**

| | | |
|--------------|-----|----------|
| 115-0 | Oak | S |
|--------------|-----|----------|



13/16 x 2-1/2 **2 Round Edge Casing**

| | | | | | |
|---------------|----------------|------------|--------------|----------|------------|
| 120P | Poplar | N/S | 120C | Cherry | N/S |
| 120-0 | Oak | N/S | 120MH | Mahogany | N/S |
| 120ALD | Superior Alder | N/S | 120MP | Maple | N/S |
| 120KA | Knotty Alder | N/S | | | |

AS

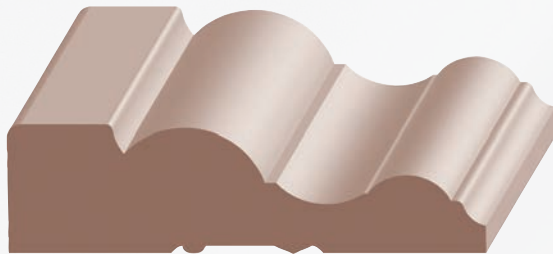

11/16 x 2-1/2 **Mission/Bel-Air Casing**

| | | | | | |
|---------------|----------------|------------|--------------|----------|------------|
| 128P | Poplar | N/S | 128C | Cherry | N/S |
| 128-0 | Oak | N/S | 128MH | Mahogany | N/S |
| 128ALD | Superior Alder | N/S | 128MP | Maple | N/S |
| 128KA | Knotty Alder | N/S | | | |

AS



5/8 x 2-1/2 **Riviera Casing**

| | | |
|--------------|-----|----------|
| 131-0 | Oak | N |
|--------------|-----|----------|

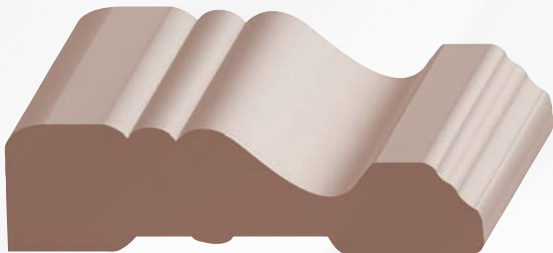

11/16 x 2-1/2 **Carolina/Mission Casing**

| | | |
|---------------|----------------|------------|
| 132P | Poplar | N |
| 132ALD | Superior Alder | N/S |

[FORMERLY 182ALD]

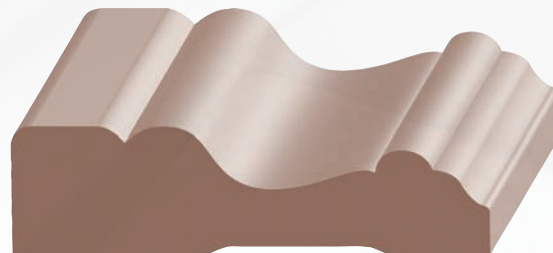

11/16 x 2-1/2 **Cape Cod Casing**

| | | | | | |
|---------------|----------------|------------|--------------|----------|------------|
| 150P | Poplar | N/S | 150C | Cherry | N/S |
| 150-0 | Oak | N/S | 150MH | Mahogany | N/S |
| 150ALD | Superior Alder | S | 150MP | Maple | N/S |



(items are approximate scale only)

2-1/2" Casing

lengths available: 6' thru 16'

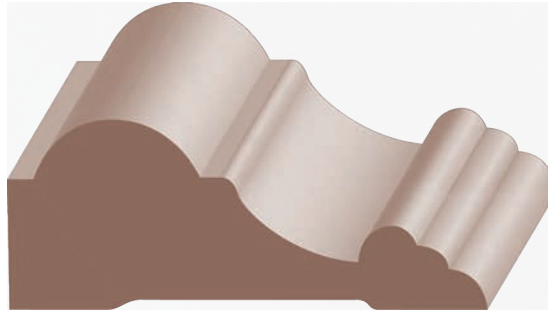

1 x 2-1/2 **Lancaster/Hermosa Casing**
159P Poplar **N/S**

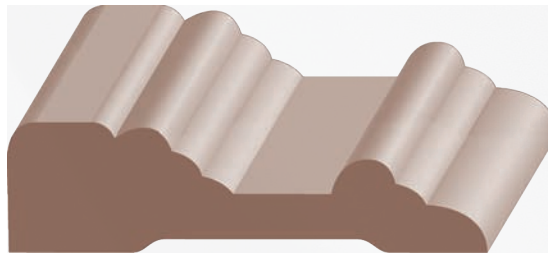

11/16 x 2-1/2 **Crescent Casing**
168P Poplar **S**
168-0 Oak **S**

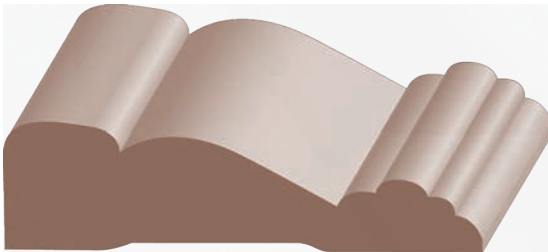

5/8 x 2-1/2 **Tudor Casing**
169-0 Oak **S**

3/4 x 2-1/2 **Victorian Casing**
169B-0 Oak **N**

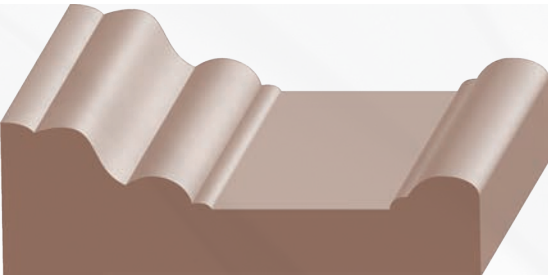

13/16 x 2-1/2 **Howe Casing**

| | | | | | |
|---------------|----------------------|------------|--------------|----------|----------|
| 178P | Poplar (3/4 x 2-1/2) | N/S | 178MH | Mahogany | N |
| 178ALD | Superior Alder | N | 178MP | Maple | N |
| 178C | Cherry | N | | | |



2-7/8" to 3-1/4" Casing

lengths available: 6' thru 16'

(items are approximate scale only)

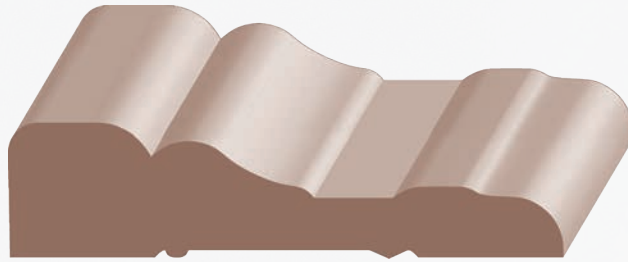

11/16 x 2-7/8 Colonial Casing

- 119P Poplar **S**
- 119O Oak **S**



11/16 x 2-7/8 Victorian/Newport Casing

- | | | | |
|-----------------------|------------|----------------|------------|
| 125P Poplar | N/S | 125C Cherry | N/S |
| 125O Oak | N/S | 125MH Mahogany | N/S |
| 125ALD Superior Alder | N/S | 125MP Maple | N/S |
| 125KA Knotty Alder | S | | |



5/16 x 3-1/4 2 Eased Edge Mullion Casing

- | | | | |
|-----------------------------|------------|------------------|------------|
| 114O3 Oak | S | 114MH-3 Mahogany | N/S |
| 114QW0-3 Qtr Sawn White Oak | N/S | 114WL-3 Walnut | N/S |

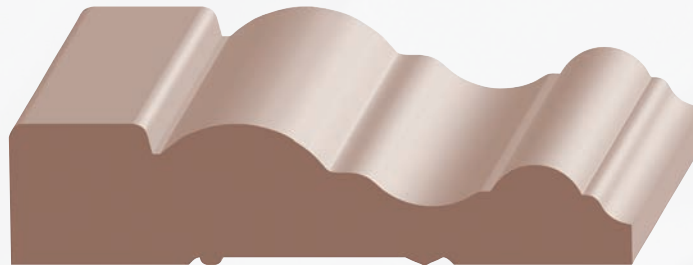

3/4 x 3-1/4 Mission/Bel-Air Casing

- | | | | |
|-----------------------|------------|----------------|------------|
| 129P Poplar | N/S | 129C Cherry | N/S |
| 129O Oak | N/S | 129MH Mahogany | N/S |
| 129ALD Superior Alder | N/S | 129MP Maple | N/S |
| 129KA Knotty Alder | N/S | | |



11/16 x 3-1/4 Monterey Casing

- 135ALD Superior Alder **N**
- 135KA Knotty Alder **N**



(items are approximate scale only)



3-1/4" Casing

lengths available: 6' thru 16'



13/16 x 3-1/4 2 Round Edge Casing

| | | | | | |
|---------------|----------------|-----|--------------|----------|-----|
| 139P | Poplar | N/S | 139C | Cherry | N/S |
| 139-O | Oak | N/S | 139MH | Mahogany | N/S |
| 139ALD | Superior Alder | N/S | 139MP | Maple | N/S |
| 139KA | Knotty Alder | N/S | | | |

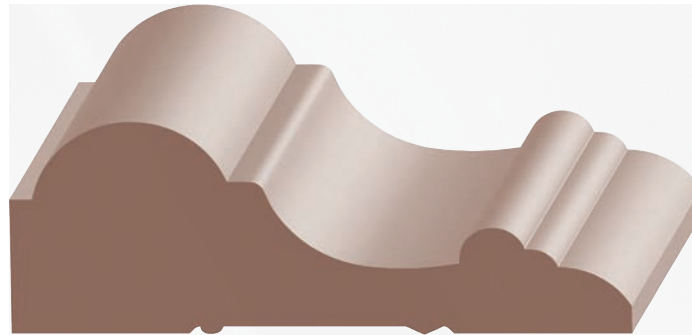

1-1/8 x 3-1/4 Lancaster/Hermosa Casing

| | | | | | |
|---------------|----------------|-----|--------------|----------|-----|
| 160P | Poplar | N/S | 160C | Cherry | N/S |
| 160-O | Oak | N/S | 160MH | Mahogany | N/S |
| 160ALD | Superior Alder | S | 160MP | Maple | N/S |
| 160KA | Knotty Alder | S | | | |

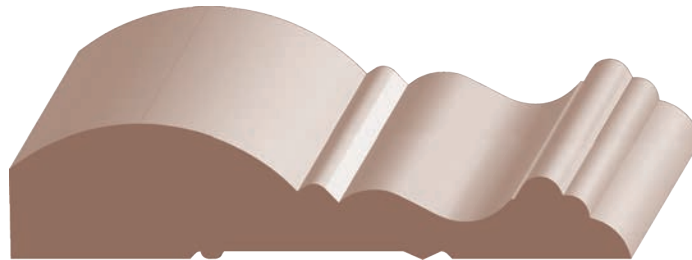

11/16 x 3-1/4 Cambridge Casing

| | | |
|--------------|-----|---|
| 161-O | Oak | S |
|--------------|-----|---|

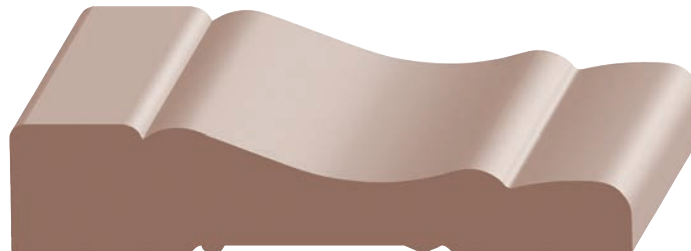

11/16 x 3-1/4 Colonial Casing

| | | | | | |
|---------------|----------------|---|--------------|----------|---|
| 176P | Poplar | N | 176C | Cherry | N |
| 176-O | Oak | N | 176MH | Mahogany | N |
| 176ALD | Superior Alder | N | 176MP | Maple | N |
| 176KA | Knotty Alder | N | | | |



3-1/4" to 3-3/8" Casing

lengths available: 6' thru 16'

(items are approximate scale only)

AS
ALL SPECIES

AS*
ALL SPECIES
EXCEPT KNOTTY ALDER

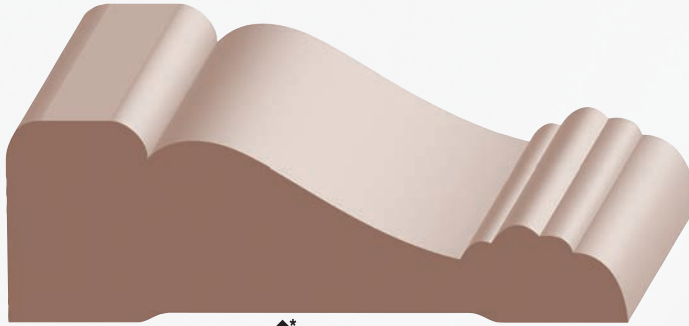

1 x 3-1/4" **49er Casing** **AS***

| | | | |
|------------------------------|----------|-----------------------|----------|
| 186P Poplar | N | 186C Cherry | N |
| 186-O Oak | N | 186MH Mahogany | N |
| 186ALD Superior Alder | N | 186MP Maple | N |

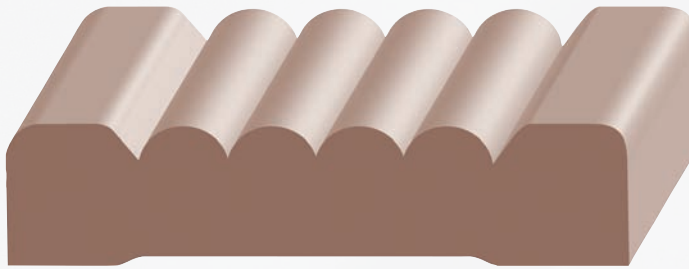

3/4 x 3-1/4" **4-Reed Casing**

| | |
|----------------------|------------|
| CA326P Poplar | N/S |
| CA326-O Oak | S |

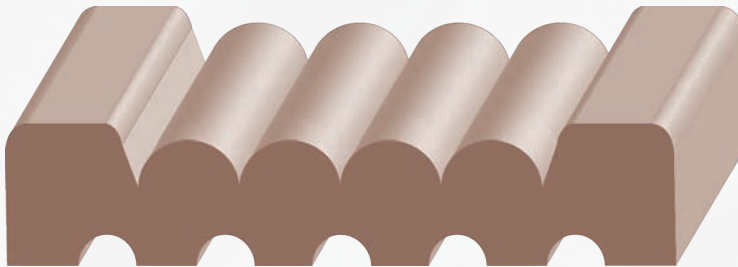

3/4 x 3-1/2" **Reversible 5-Flute & Reed Casing** **AS***

| | | | |
|------------------------------|------------|-----------------------|------------|
| 158P Poplar | N/S | 158C Cherry | N/S |
| 158-O Oak | N/S | 158MH Mahogany | N/S |
| 158ALD Superior Alder | N/S | 158MP Maple | N/S |

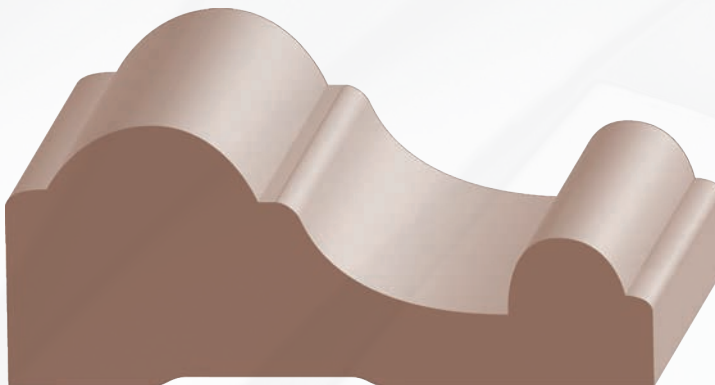

1-3/8 x 3-3/8" **Malibu Casing**

| | |
|--------------------|------------|
| 180P Poplar | N/S |
|--------------------|------------|

(items are approximate scale only)

3-1/2" Casing

lengths available: 6' thru 16'

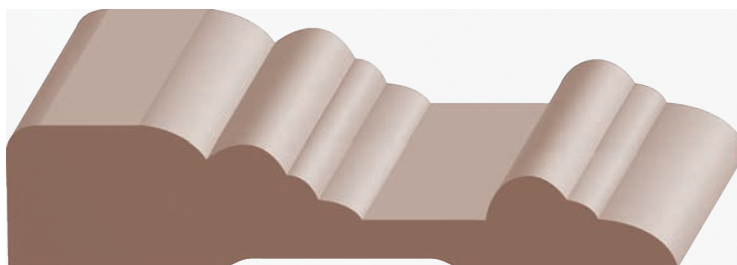

3/4 x 3-1/2 Crescent Casing

- 126P** Poplar S
- 126-O** Oak S

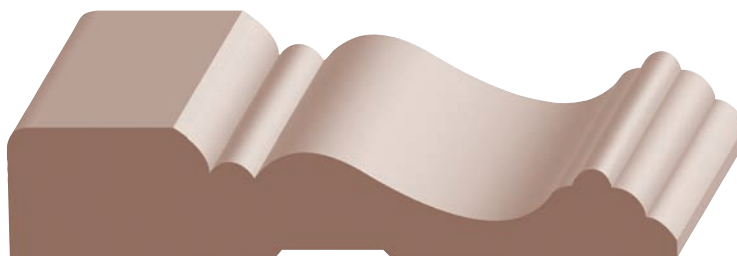

11/16 x 3-1/2 Cape Cod Casing

- 155P** Poplar N/S
- 155-O** Oak S
- 155ALD** Superior Alder S

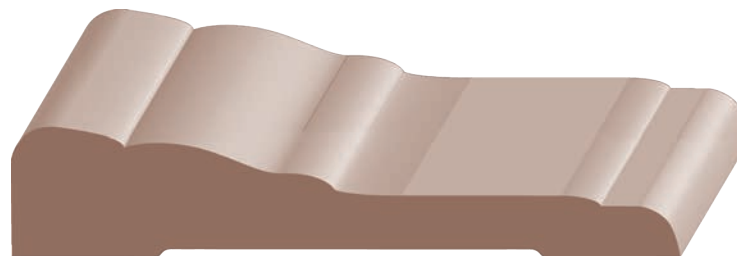

11/16 x 3-1/2 Chesapeake Casing

- 156-O** Oak S



1 x 3-1/2 Santa Fe Casing

- | | |
|---|--|
| 166P Poplar N | 166C Cherry N |
| 166ALD Superior Alder N | 166MH Mahogany N |
| 166KA Knotty Alder N | 166MP Maple N |

1-1/16 x 3-1/2 #275 Casing

- | | |
|--|---|
| 165P Poplar S | 165C Cherry S |
| 165ALD Superior Alder S | 165MH Mahogany S |
| 165KA Knotty Alder S | 165MP Maple S |



3-1/2" to 3-3/4" Casing

(items are approximate scale only)

lengths available: 6' thru 16'

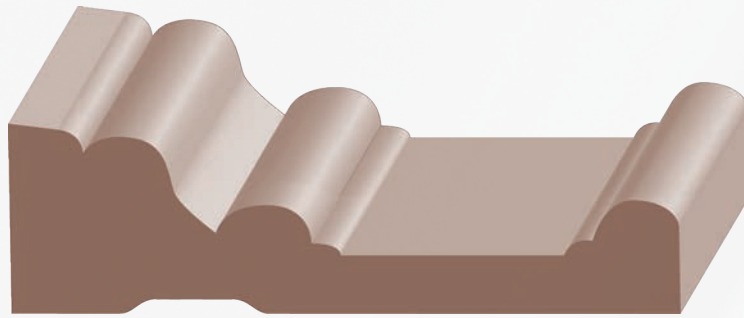

- 1 x 3-1/2 Howe Casing**
- | | | | | | |
|---------------|----------------|-----|--------------|----------|---|
| 177P | Poplar | N/S | 177C | Cherry | N |
| 177ALD | Superior Alder | N | 177MH | Mahogany | N |
| 177KA | Knotty Alder | N | 177MP | Maple | N |

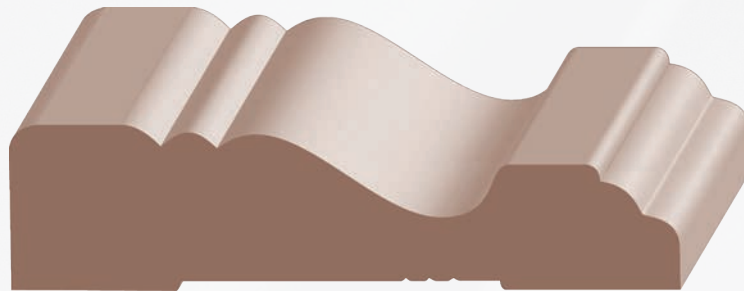

- | | | | | | |
|------------------------------------|------------------------------|---|------------------------------------|----------------|---|
| 3/4 x 3-1/2 Carolina Casing | | | 7/8 x 3-1/2 Palisade Casing | | |
| 133P | Poplar | N | 185ALD | Superior Alder | S |
| 133-0 | Oak | N | | | |
| 133ALD | Superior Alder (7/8 x 3-1/2) | N | | | |

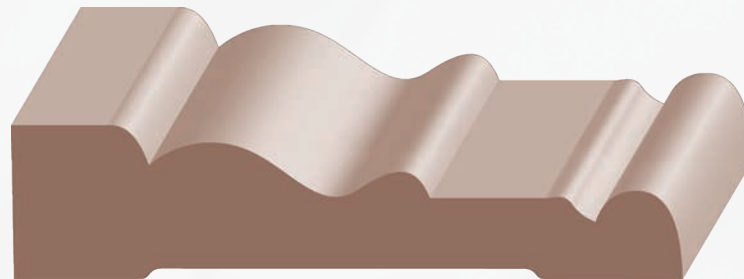

- 13/16 x 3-1/2 Tuscan Casing**
CA364P Poplar S

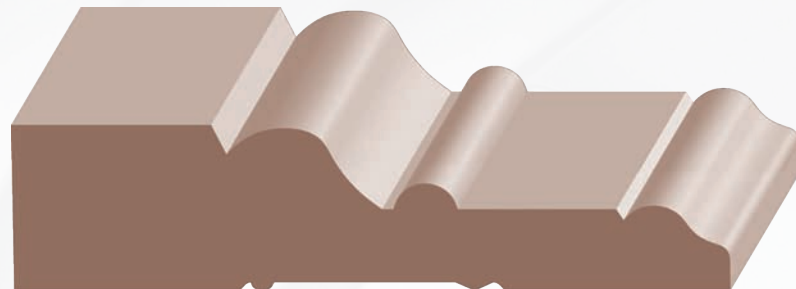

- 13/16 x 3-3/4 Sierra/Tuscany Casing**
- | | | |
|--------------|----------|-----|
| 175-0 | Oak | N/S |
| 175C | Cherry | S |
| 175MH | Mahogany | S |
| 175MP | Maple | S |

(items are approximate scale only)

4" to 4-1/4" Casing

lengths available: 6' thru 16'

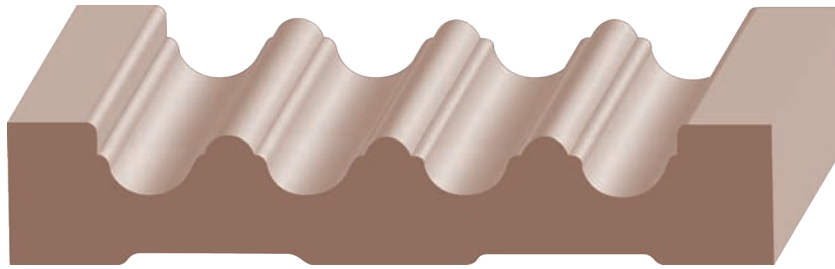

3/4 x 4 **Fancy 4-Flute Casing**
CA327P Poplar **N/S**



3/4 x 4 **2 Eased Edge Craftsman Casing**
199ALD Superior Alder **N/S** [FORMERLY KNOWN AS 186ALD]
199KA Knotty Alder **N/S**

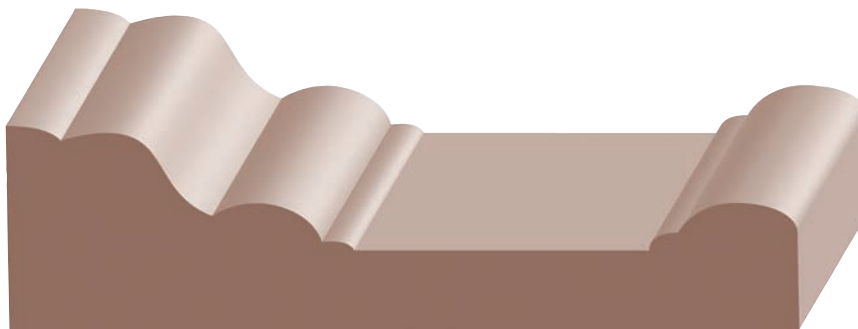

1-1/16 x 4-1/8 **Howe Casing**
174P Poplar **N/S**

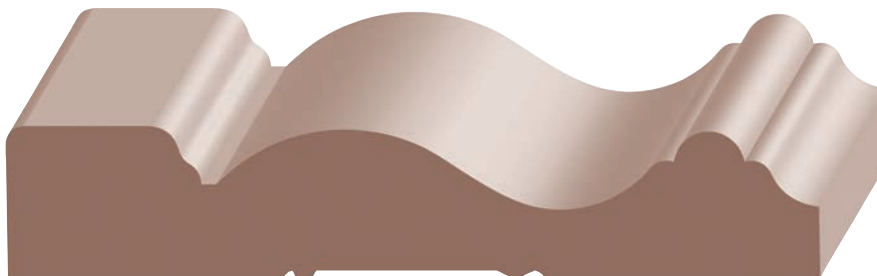

13/16 x 4-1/4 **Monterey Casing**
136ALD Superior Alder **N**

4-1/4" to 5" Casing

(items are approximate scale only)

lengths available: 6' thru 16'

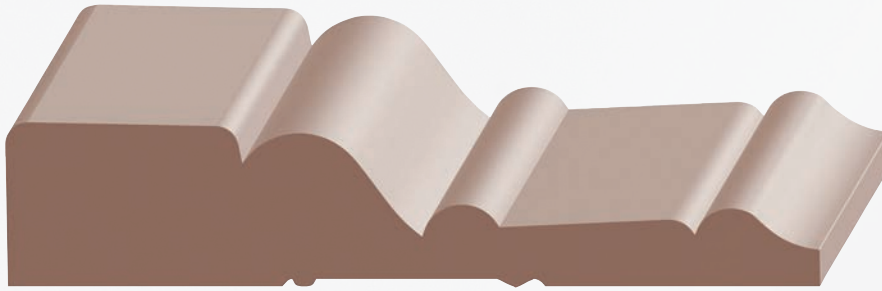

7/8 x 4-1/4 **Tuscany Casing**

140P Poplar **N/S**

140-0 Oak **N**

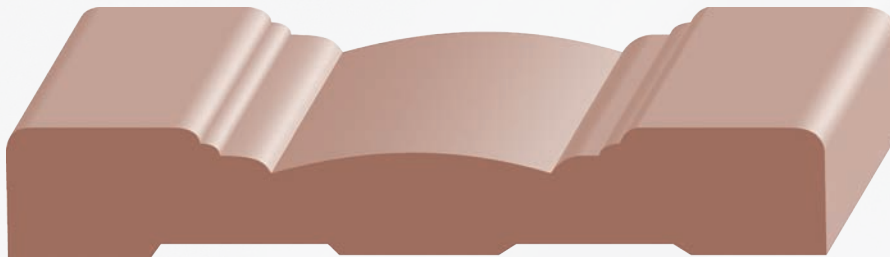

11/16 x 4-1/4 **Victorian Casing / Chair Rail**

184-0 Oak **S**

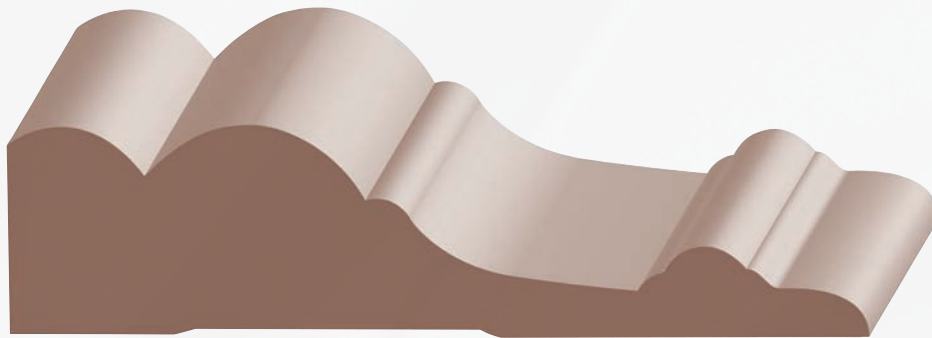

1-1/8 x 4-1/2 **Belvedere/Sedona Casing**

190P Poplar **N/S**

190ALD Superior Alder **N**

190KA Knotty Alder **N**

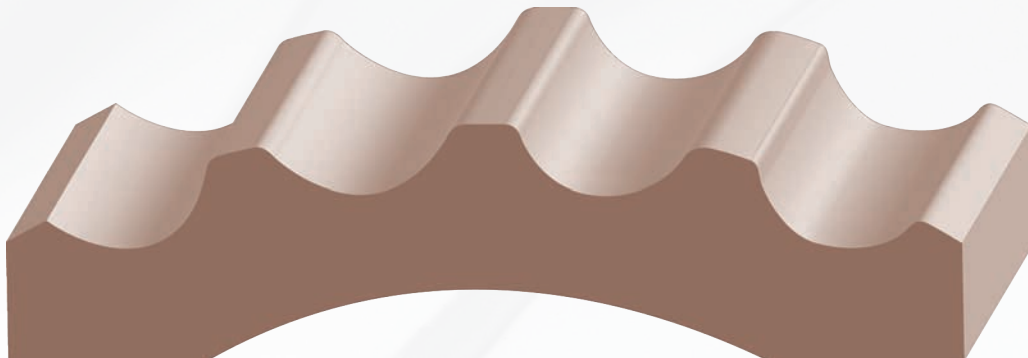

1-1/4 x 5 **Fluted Radial Casing**

191P Poplar **S**

(items are approximate scale only)

5-1/2" Casing

✂ lengths available: 6' thru 16'

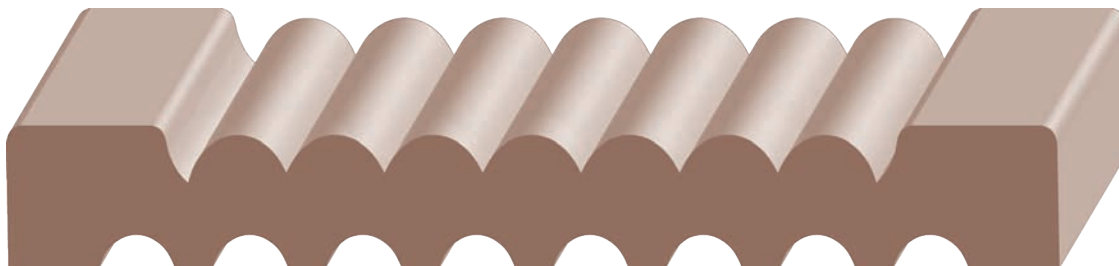

3/4 x 5-1/2 **Reversible 8 Flute & Reed Casing**
171P Poplar **S**



5/16 x 5-1/2 **2 Eased Edge Mullion Casing**
114MH-5 Mahogany **N/S**
114WL-5 Walnut **N/S**
114QW0-5 Qtr Sawn White Oak **N/S**

Header

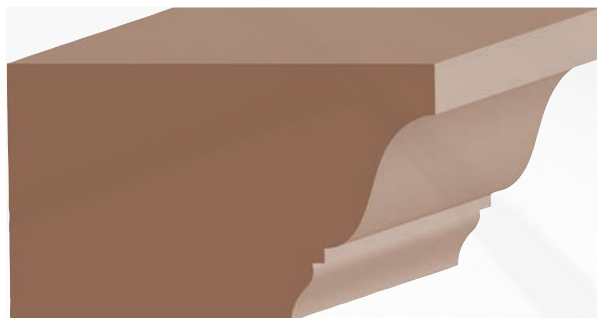

1-3/4 x 2-1/4 **Door Header Cap**
HC150P Poplar **N/S**
HC150-O Oak **S**
 1-5/16 x 2-1/4 **Door Header Cap**
HC150ALD Superior Alder **N/S**

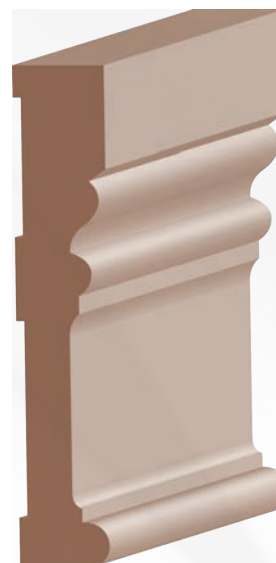

1-1/16 x 5-1/4 **Door Header**
DH190P Poplar **N/S**
DH190-O Oak **N/S**



Stop

lengths available: 6' thru 16'

(items are approximate scale only)

AS*
ALL SPECIES
EXCEPT KNOTTY ALDER



7/16 x 1-1/4 1 RE Door Stop
201P Poplar **N** | **201C** Cherry **N**
201-0 Oak **N** | **201MH** Mahogany **N**
201ALD Superior Alder **N** | **201MP** Maple **N**



3/8 x 1-1/4 1 RE Stop
202P Poplar **S**
202-0 Oak **S**

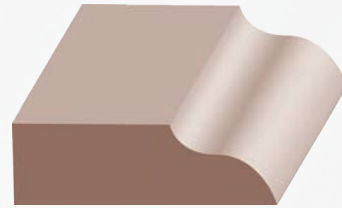

1/2 x 1-1/2 Ogee Stop
219-0 Oak **N**



1/2 x 1-1/2 2 RE Door Stop
209BALD Superior Alder **N**



1/2 x 1-1/2 1 RE Door Stop
209P Poplar **S** | **209C** Cherry **S**
209-0 Oak **S** | **209MH** Mahogany **S**
209ALD Superior Alder **N/S** | **209MP** Maple **S**



1/2 x 1-3/4 Colonial/Ogee Stop
210P Poplar **N/S** | **210C** Cherry **N**
210-0 Oak **S** | **210MH** Mahogany **N**
210ALD Superior Alder **N/S** | **210MP** Maple **N**

Base, Base Shoe & Stop

lengths available: 5' thru 16'

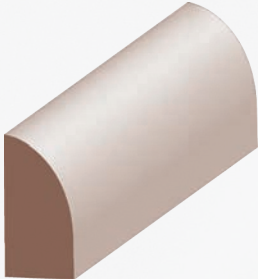

3/8 x 3/4 Base Shoe
300A-0 Oak **S**



1/2 x 3/4 Base Shoe
300BP Poplar **N/S** | **300BC** Cherry **N/S**
300B-0 Oak **N/S** | **300BMH** Mahogany **N/S**
300BALD Superior Alder **N/S** | **300BMP** Maple **N/S**



3/8 x 2-1/4 Reversible Base
R304-02 Oak **N**

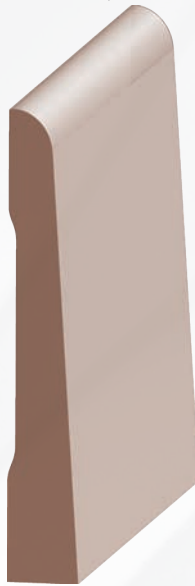

3/8 x 2-1/2 Streamline Base
306-0 Oak **S**



3/8 x 2-1/2 #711 Base
310-0 Oak **S**

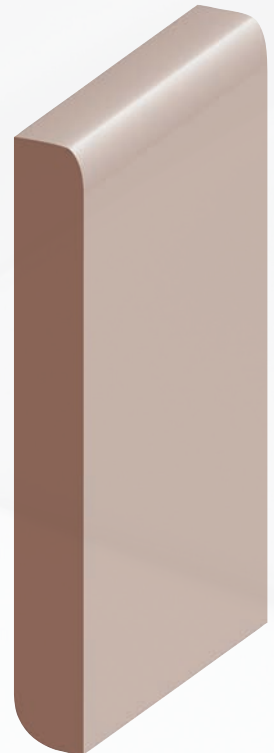

3/8 x 3-1/4 Reversible Base
R304-03 Oak **N**

(items are approximate scale only)

3-1/4" to 3-1/2" Base

lengths available: 6' thru 16'

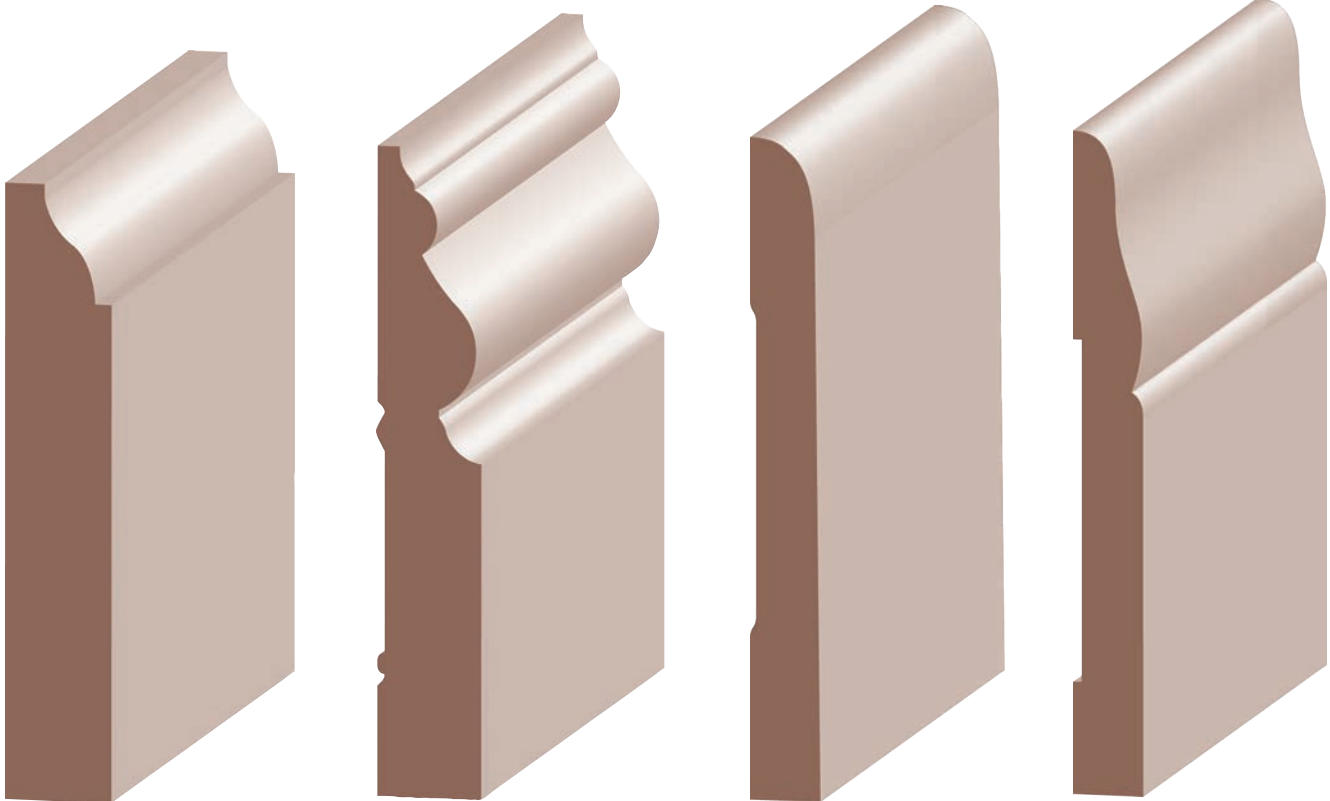

9/16 x 3-1/4 **Coronado/#623 Base**

| | | |
|-----------------|----------------|-----|
| 314P-3 | Poplar | N |
| 314O3 | Oak | N/S |
| 314ALD-3 | Superior Alder | N/S |
| 314KA-3 | Knotty Alder | N |
| 314C-3 | Cherry | N |
| 314MH-3 | Mahogany | N/S |
| 314MP-3 | Maple | N/S |

9/16 x 3-3/4 **Santa Fe/#175 Base**

| | | |
|---------------|--------|-----------------------|
| 338P-3 | Poplar | N/S [FORMERLY 362P] |
| 338O3 | Oak | N |

3/8 x 3-1/2 **Streamline Base**

| | | |
|--------------|-----|---|
| 307-0 | Oak | S |
|--------------|-----|---|

3/8 x 3-1/2 **#711 Base**

| | | |
|-----------------|----------------|---|
| 311P-3 | Poplar | S |
| 311-0 | Oak | S |
| 311ALD-3 | Superior Alder | S |
| 311MH-3 | Mahogany | S |



3-7/8" to 4-1/4" Base

lengths available: 6" thru 16"

(items are approximate scale only)

AS
ALL SPECIES

AS*
ALL SPECIES
EXCEPT KNOTTY ALDER



AS

9/16 x 3-7/8 **Victorian/Newport Base**

| | | |
|---------------|----------------|-----|
| 329P | Poplar | N/S |
| 329-O | Oak | N/S |
| 329ALD | Superior Alder | N/S |
| 329KA | Knotty Alder | S |
| 329C | Cherry | N/S |
| 329MH | Mahogany | N/S |
| 329MP | Maple | N/S |



AS*

9/16 x 3-3/4 **Mission/Hermosa Base**

| | | |
|---------------|----------------|-----|
| 324P | Poplar | N/S |
| 324-O | Oak | N/S |
| 324ALD | Superior Alder | N/S |
| 324C | Cherry | N/S |
| 324MH | Mahogany | N/S |
| 324MP | Maple | N/S |



AS*

9/16 x 4 **Cape Cod Base**

| | | |
|-----------------|----------------|-----|
| 318P-4 | Poplar | N/S |
| 318-O4 | Oak | N/S |
| 318ALD-4 | Superior Alder | S |
| 318C-4 | Cherry | N/S |
| 318MH-4 | Mahogany | N/S |
| 318MP-4 | Maple | N/S |

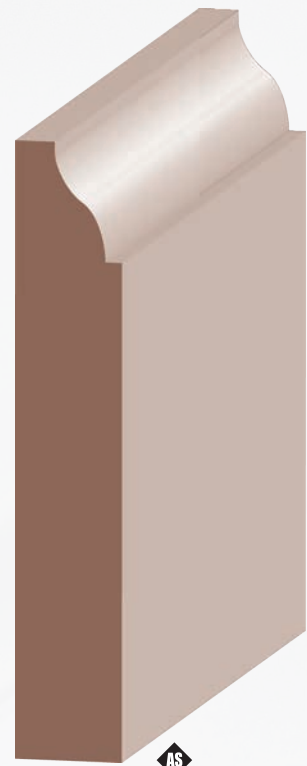

AS

9/16 x 4-1/4 **Coronado/#623 Base**

| | | |
|-----------------|----------------|-----|
| 314P-4 | Poplar | N/S |
| 314-O4 | Oak | N/S |
| 314ALD-4 | Superior Alder | N/S |
| 314KA-4 | Knotty Alder | N |
| 314C-4 | Cherry | N/S |
| 314MH-4 | Mahogany | N/S |
| 314MP-4 | Maple | N/S |



(items are approximate scale only)

4-3/16" to 4-1/4" Base

lengths available: 6' thru 16'

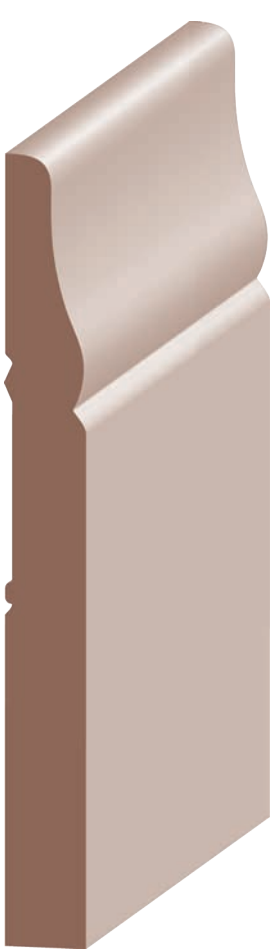

7/16 x 4-3/16 **#711 Base**
311P-4 Poplar **S**

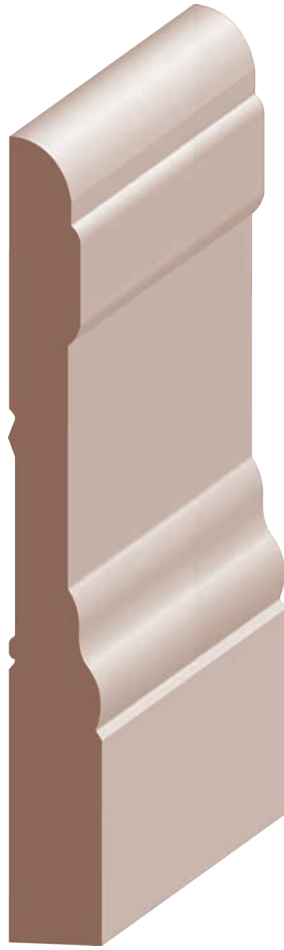

1/2 x 4-1/4 **Colonial Base**
118P-4 Poplar **S**
118-04 Oak **S**

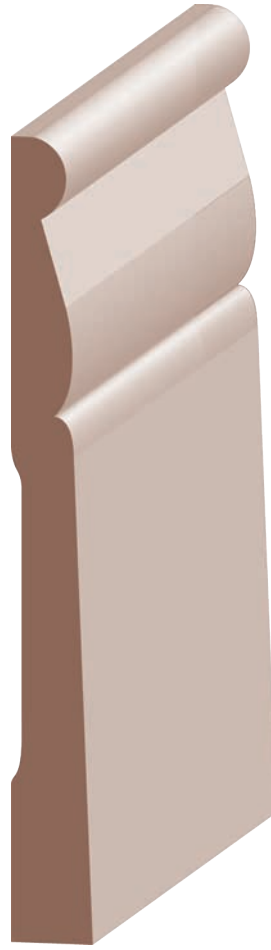

7/16 x 4-1/4 **Monterey Base**
316-0 Oak **S**

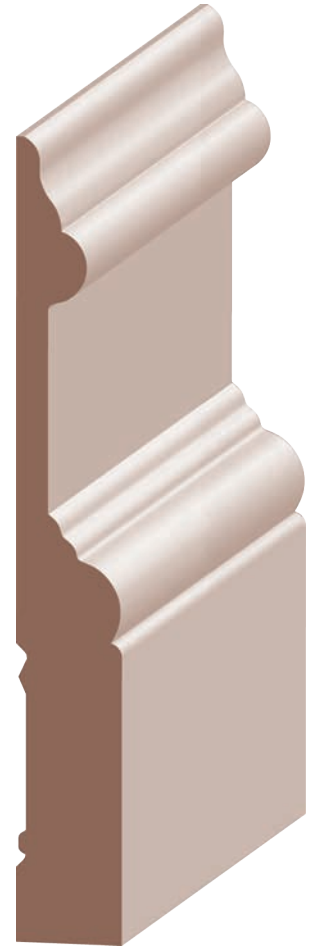

9/16 x 4-1/4 **Crescent Base**
326P Poplar **S**
326-0 Oak **S**

4-1/4" to 4-3/8" Base

lengths available: 6" thru 16"

(items are approximate scale only)

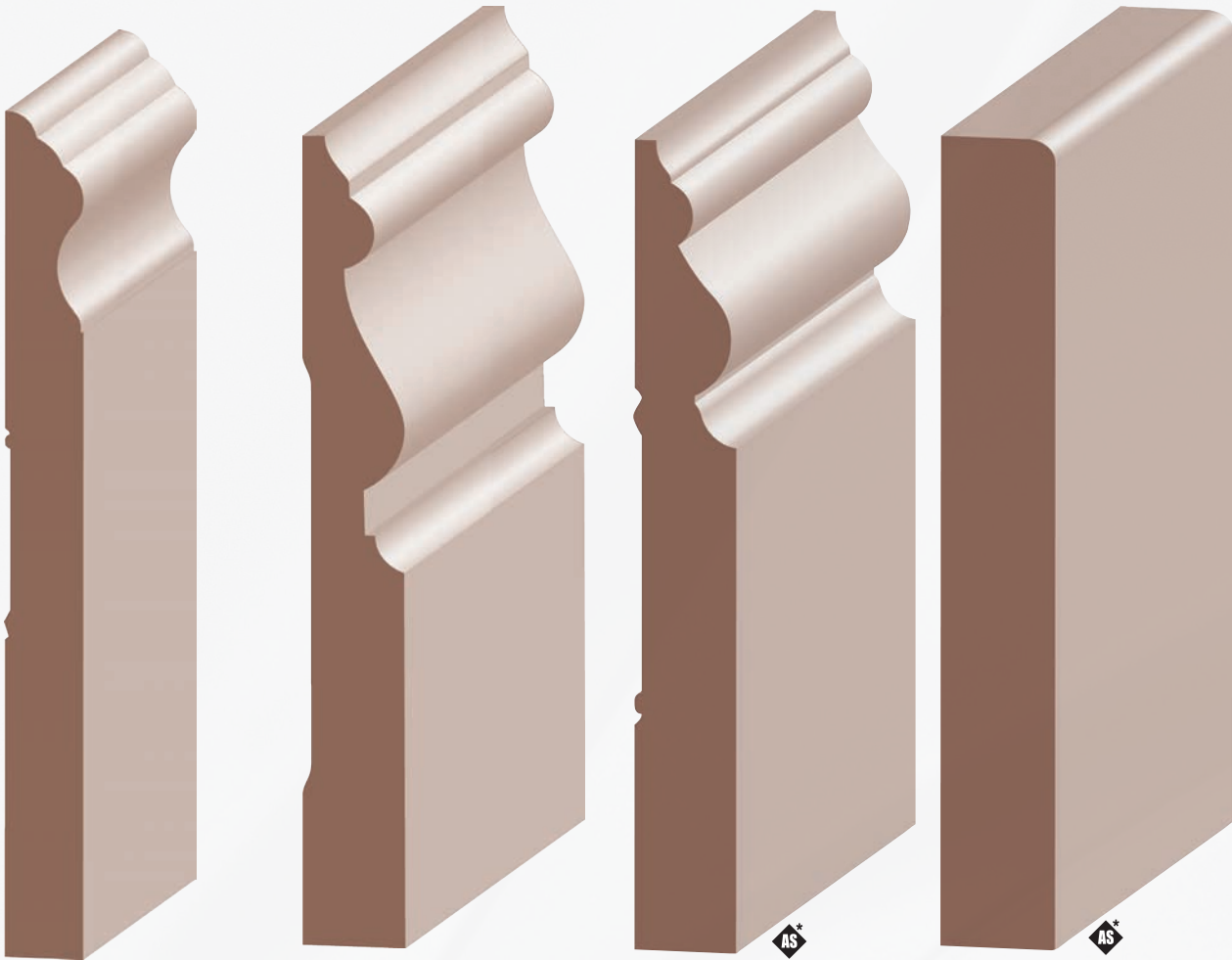

5/8 x 4-1/4 **Mission Bay Base**

333P-4 Poplar **S**
[FORMERLY 361PM]

9/16 x 4-3/8 **Imperial/#175 Base**

325P Poplar **S**
325ALD Superior Alder **S**
325C Cherry **S**
325MH Mahogany **S**
325MP Maple **S**

9/16 x 4-3/8 **Santa Fe Base**

338P-4 Poplar **N**
338-04 Oak **N**
338ALD-4 Superior Alder **N**
338C-4 Cherry **N**
338MH-4 Mahogany **N**
338MP-4 Maple **N**

5/8 x 4-3/8 **1 Eased Edge Craftsman Base**

387P-4 Poplar **N/S**
387-04 Oak **N/S**
387ALD-4 Superior Alder **N/S**
387C-4 Cherry **N/S**
387MH-4 Mahogany **N/S**
387MP-4 Maple **N/S**

[FORMERLY 348P]



(items are approximate scale only)

5" to 5-1/4" Base

lengths available: 6' thru 16'

AS
ALL SPECIES

AS*
ALL SPECIES
EXCEPT KNOTTY ALDER



5/8 x 5 **Mission/Hermosa Base**

| | | |
|--------------|----------|-----|
| 323P | Poplar | N/S |
| 323-O | Oak | N/S |
| 323C | Cherry | N/S |
| 323MH | Mahogany | N/S |
| 323MP | Maple | N/S |

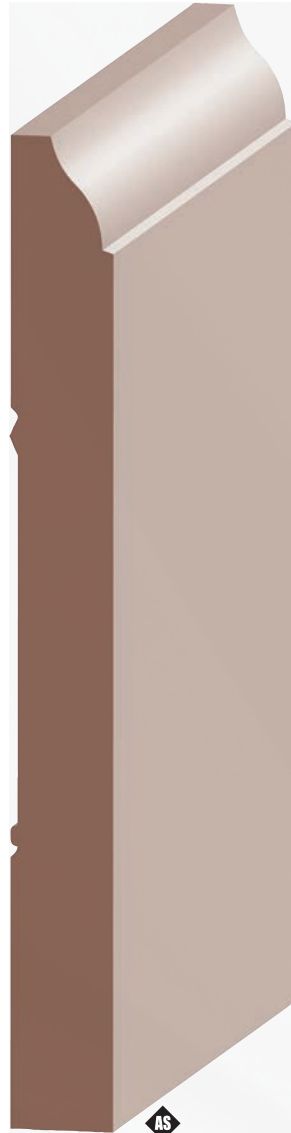

9/16 x 5-1/4 **Coronado/#618 Base**

| | | |
|-----------------|----------------|-----|
| 314P-5 | Poplar | N/S |
| 314-O5 | Oak | N/S |
| 314ALD-5 | Superior Alder | N/S |
| 314KA-5 | Knotty Alder | N |
| 314C-5 | Cherry | N/S |
| 314MH-5 | Mahogany | N/S |
| 314MP-5 | Maple | N/S |



9/16 x 5-1/4 **Cape Cod Base**

| | | |
|-----------------|----------------|-----|
| 318P-5 | Poplar | N/S |
| 318-O5 | Oak | S |
| 318ALD-5 | Superior Alder | S |
| 318C-5 | Cherry | N/S |
| 318MH-5 | Mahogany | N/S |
| 318MP-5 | Maple | N/S |



9/16 x 5-1/4 **Victorian Base**

| | | |
|----------------|----------------|---|
| 330BP | Poplar | N |
| 330B-O | Oak | N |
| 330BALD | Superior Alder | N |
| 330BC | Cherry | N |
| 330BMH | Mahogany | N |
| 330BMP | Maple | N |

9/16 x 5 **Newport Base**

| | | |
|---------------|----------------|---|
| 330P | Poplar | S |
| 330-O | Oak | S |
| 330ALD | Superior Alder | S |
| 330KA | Knotty Alder | S |
| 330C | Cherry | S |
| 330MH | Mahogany | S |
| 330MP | Maple | S |



5-1/4" Base

lengths available: 6" thru 16"

(items are approximate scale only)

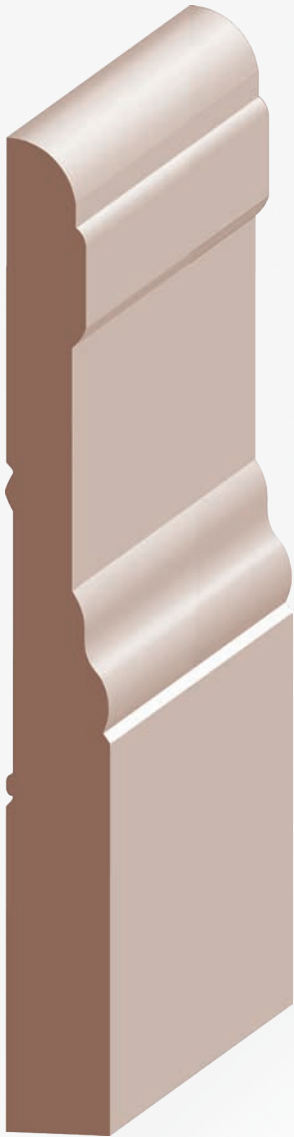

9/16 x 5-1/4 **Colonial Base**
118P-5 Poplar **S**

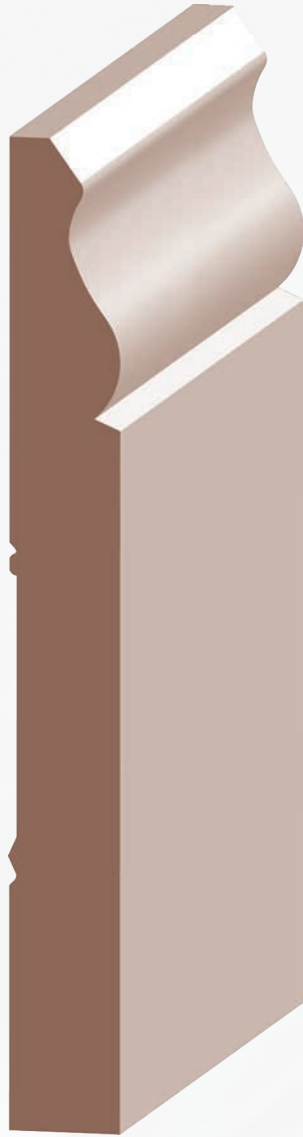

9/16 x 5-1/4 **Vintage/Colonial Base**
328P-5 Poplar **S**
328ALD-5 Superior Alder **N/S**
328KA-5 Knotty Alder **N**



9/16 x 5-1/4 **Classic Beaded Base**
359P Poplar **N**



AS*
5/8 x 5-1/4 **Monterey Base**
361P-5 Poplar **N**
361O-5 Oak **N**
361ALD-5 Superior Alder **N**
361KA-5 Knotty Alder **N**
361C-5 Cherry **N**
361MH-5 Mahogany **N**
361MP-5 Maple **N**



(items are approximate scale only)

AS
ALL SPECIES

5-1/4" to 5-7/16" Base

lengths available: 6' thru 16'

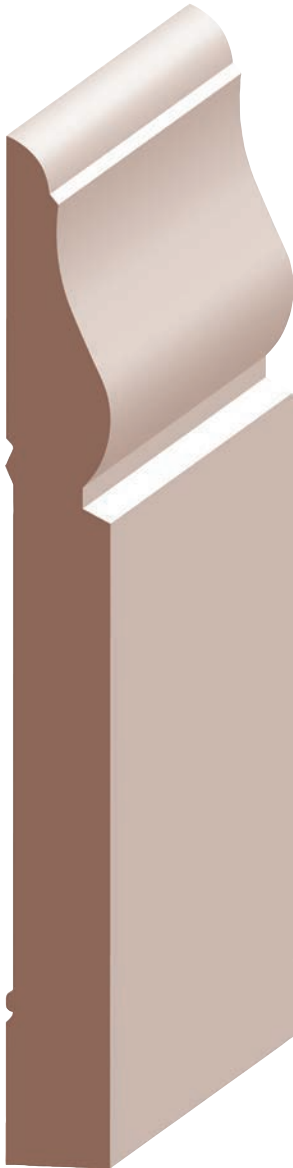

3/4 x 5-1/4 **Crescent Base**
365P-5 Poplar **N**



9/16 x 5-3/8 **Santa Fe/#175 Base**
338P-5 Poplar **N/S**
338O-5 Oak **N**
338ALD-5 Superior Alder **N**
338KA-5 Knotty Alder **N**
338C-5 Cherry **N/S**
338MH-5 Mahogany **N/S**
338MP-5 Maple **N/S**

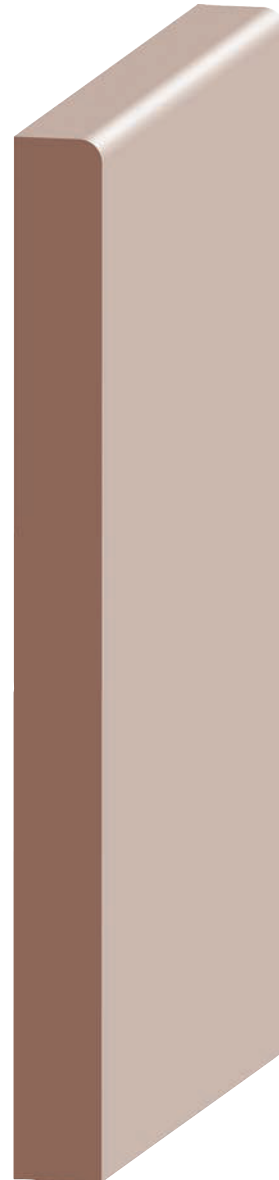

5/8 x 5-7/16 **1 Eased Edge Craftsman Base**
387KA-5 Knotty Alder **N**



5-3/4" to 6" Base

lengths available: 6" thru 16"

(items are approximate scale only)

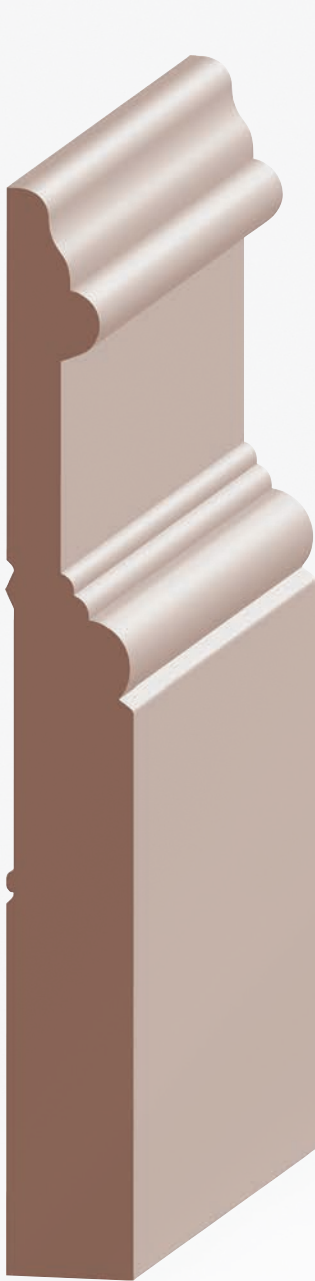

11/16 x 5-3/4
332P Poplar *N/S*
**Santa Clara/
 Crescent Base**



5/8 x 6
360P Poplar *S*
Cape Cod Base



11/16 x 6
375P-6 Poplar *N/S*
375-06 Oak *N/S*
375C-6 Cherry *S*
375MH-6 Mahogany *S*
375MP-6 Maple *S*
Tuscany Base

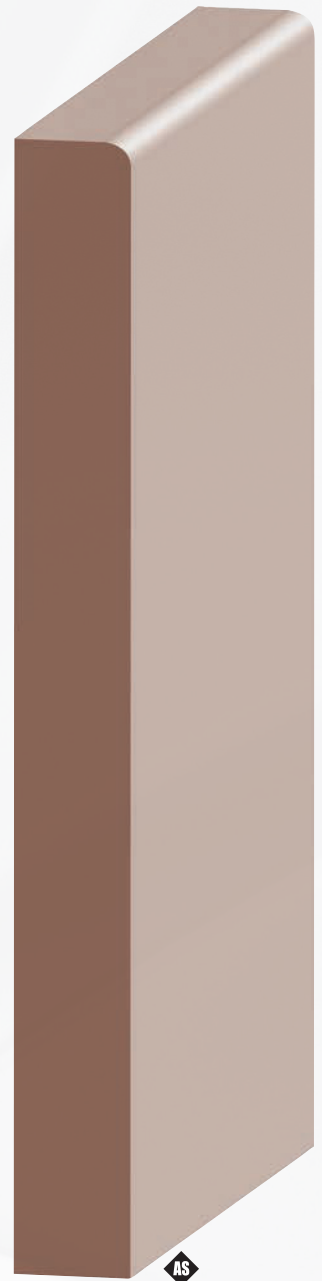

5/8 x 6
387P-6 Poplar *N/S*
387-06 Oak *N/S*
387ALD-6 Superior Alder *N/S*
387KA-6 Knotty Alder *S*
387C-6 Cherry *N/S*
387MH-6 Mahogany *N/S*
387MP-6 Maple *N/S*
1 Eased Edge Craftsman Base



(items are approximate scale only)

AS*
ALL SPECIES
EXCEPT KNOTTY ALDER

6" to 7-1/4" Base

lengths available: 6' thru 16'

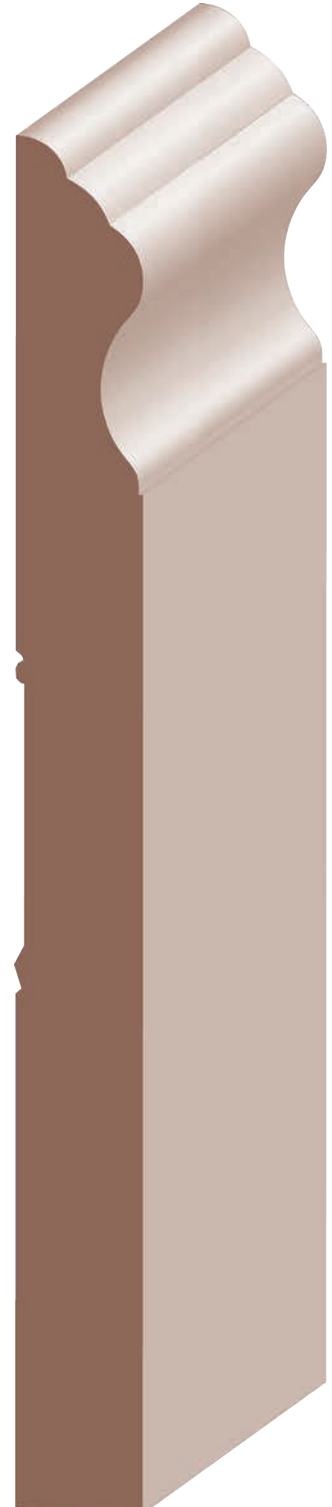
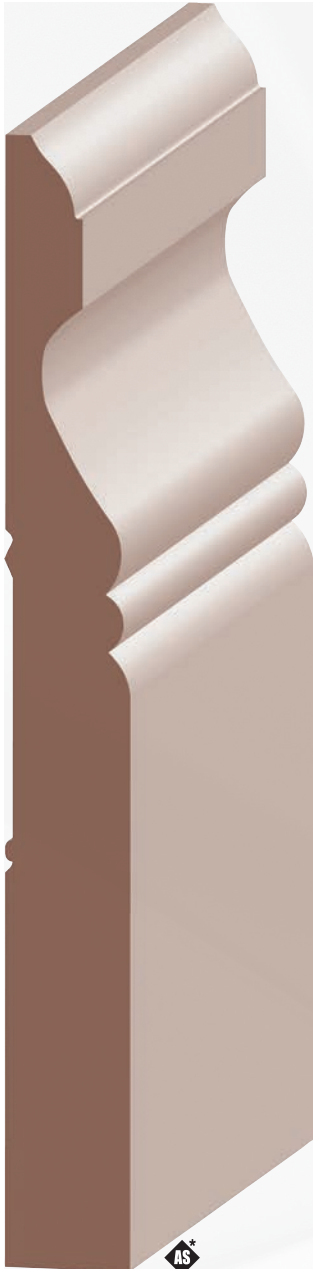

5/8 x 6 **Carolina/Palisade Base**
385P Poplar **N**
385-O Oak **N**
385ALD Superior Alder **N/S**
385C Cherry **N**
385MH Mahogany **N**
385MP Maple **N**

5/8 x 6-1/4 **Imperial/#175 Base**
342P-6 Poplar **N/S**
342ALD-6 Superior Alder (5/8 x 6) **N/S**
342KA-6 Knotty Alder (5/8 x 6) **N/S**
342C-6 Cherry **S**
342MH-6 Mahogany **S**
342MP-6 Maple **S**

11/16 x 7-1/4 **Tuscany Base**
375P-7 Poplar **S**

11/16 x 7-1/4 **Mission Bay Base**
333P-7 Poplar **S**



7-3/16" to 7-1/4" Base

lengths available: 6' thru 16'

(items are approximate scale only)



ALL SPECIES
EXCEPT KNOTTY ALDER

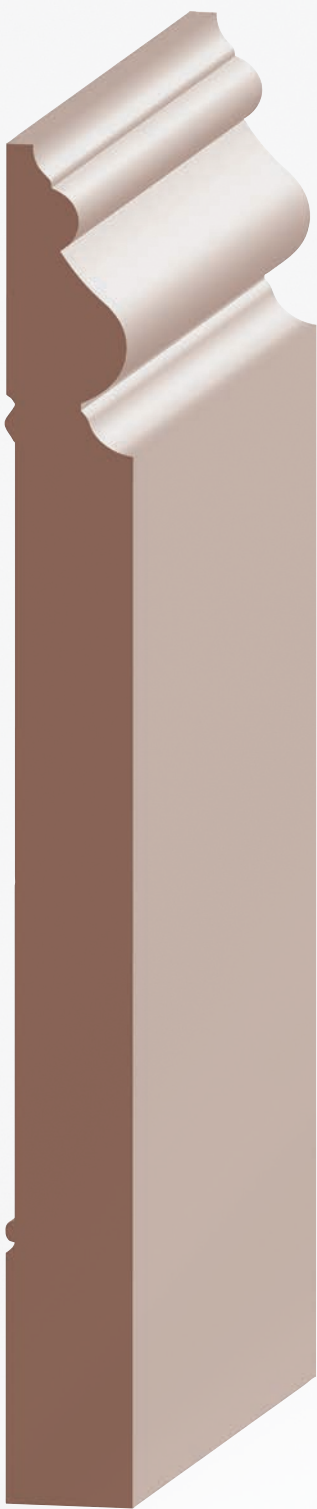

11/16 x 7-3/16 **Santa Fe/#175 Base**
338P-7 Poplar *N/S*

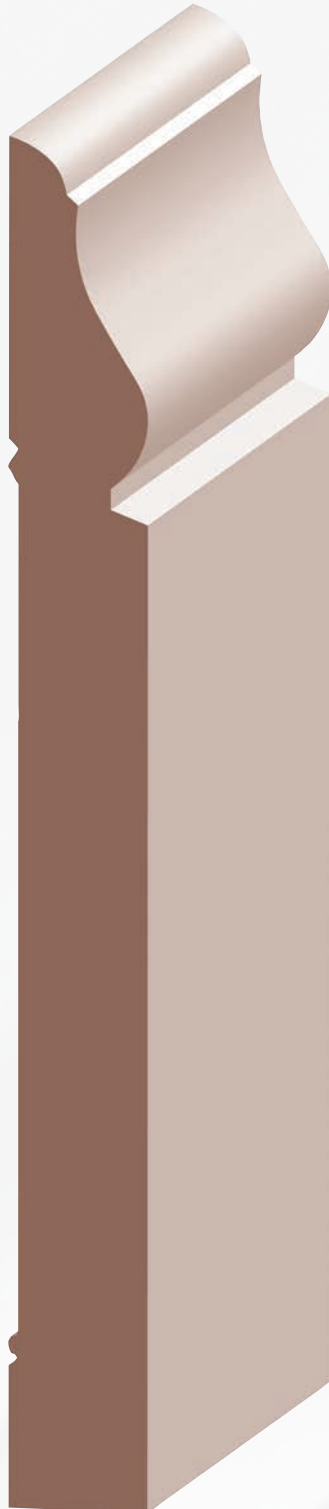

3/4 x 7-1/4 **Crescent Base**
365P-7 Poplar **N**



11/16 x 7-1/4 **Malibu/Hermosa Base**
340P Poplar *N/S*
340ALD Superior Alder *N/S*

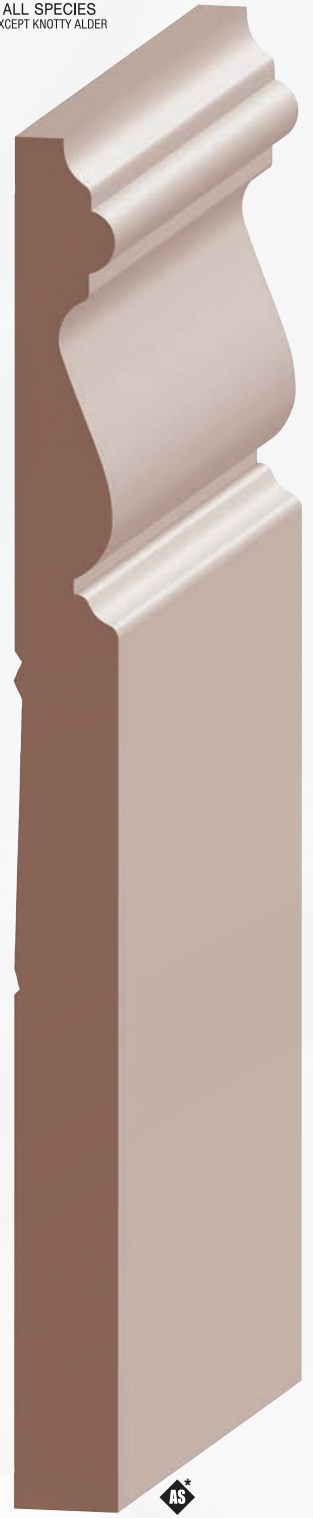

9/16 x 7-1/4 **Monterey Base**
361P-7 Poplar *N/S*
361-07 Oak **N**
361ALD-7 Superior Alder *N/S*
361C-7 Cherry *N/S*
361MH-7 Mahogany *N/S*
361MP-7 Maple *N/S*



(items are approximate scale only)

1-5/8" to 3-1/4" Crown

lengths available: 6' thru 16'



ALL SPECIES
EXCEPT KNOTTY ALDER

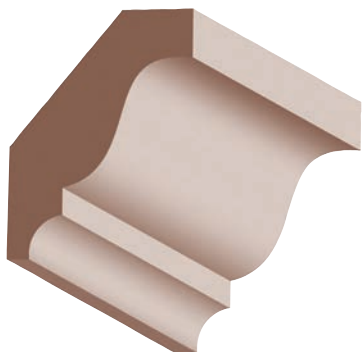

1/2 x 1-5/8 **Colonial Crown**
400-0 Oak **N**

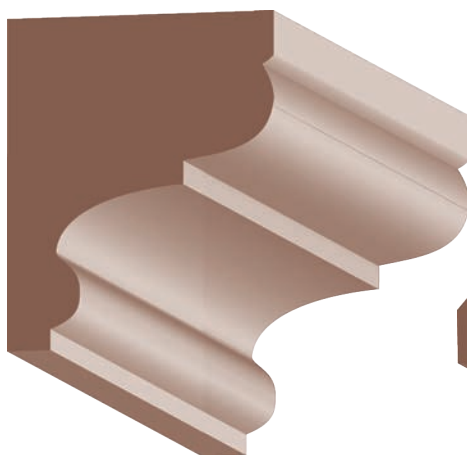

1-7/16 x 1-3/4 **Bed/Cabinet Crown**
452P Poplar **S**
[FORMERLY 403P]

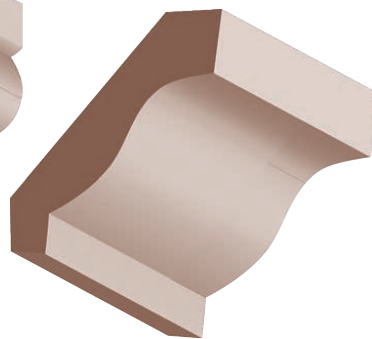

1/2 x 1-5/8 **Crown**
401-01 Oak **S**

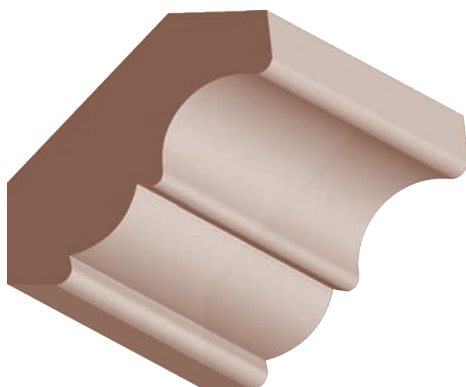

9/16 x 1-7/8 **Bed Mold Crown**
420ALD Superior Alder **S**

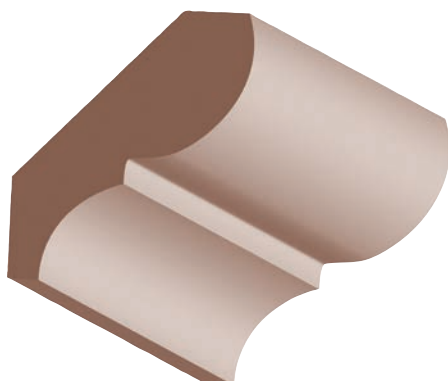

9/16 x 1-7/8 **Bed Mold Crown**
437ALD Superior Alder **N**

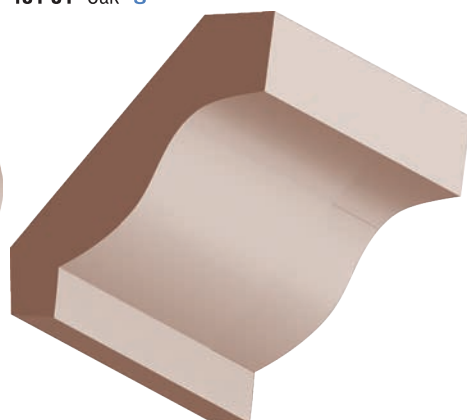

1/2 x 2-1/4 **Crown**
401-02 Oak **S**

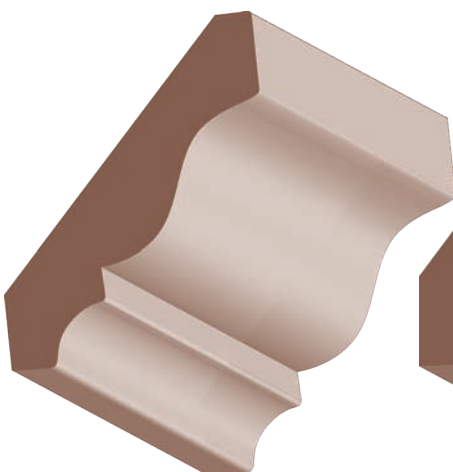

1/2 x 2-1/4 **Colonial Crown**
404-0 Oak **S**

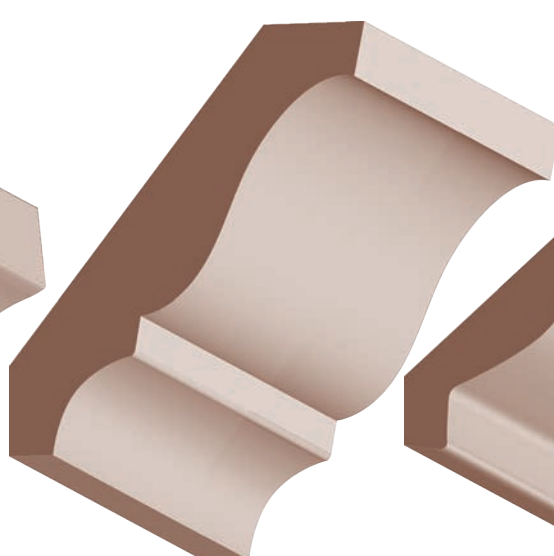

1/2 x 2-3/4 **Colonial Crown**
436P Poplar **N/S**
436-0 Oak **N/S**
436ALD Superior Alder **N/S**
436C Cherry **N/S**
436MH Mahogany **N/S**
436MP Maple **N/S**

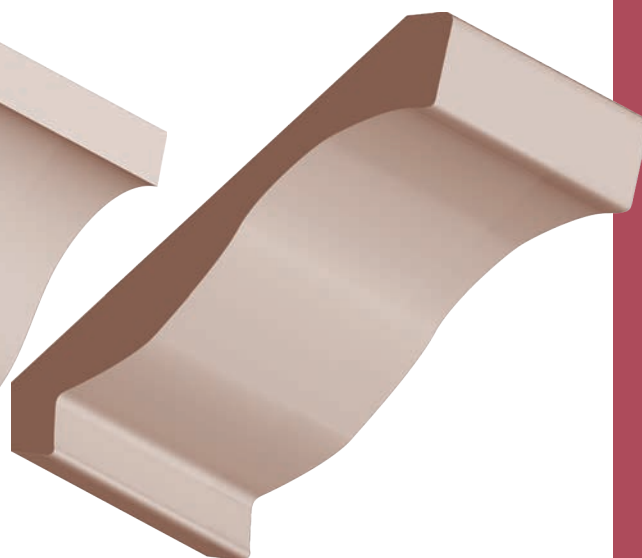

1/2 x 3-1/4 **Crown**
401-03 Oak **S**
[FORMERLY 402-O]



3-1/4" to 3-7/16" Crown

(items are approximate scale only)

lengths available: 6" thru 16"

AS
ALL SPECIES

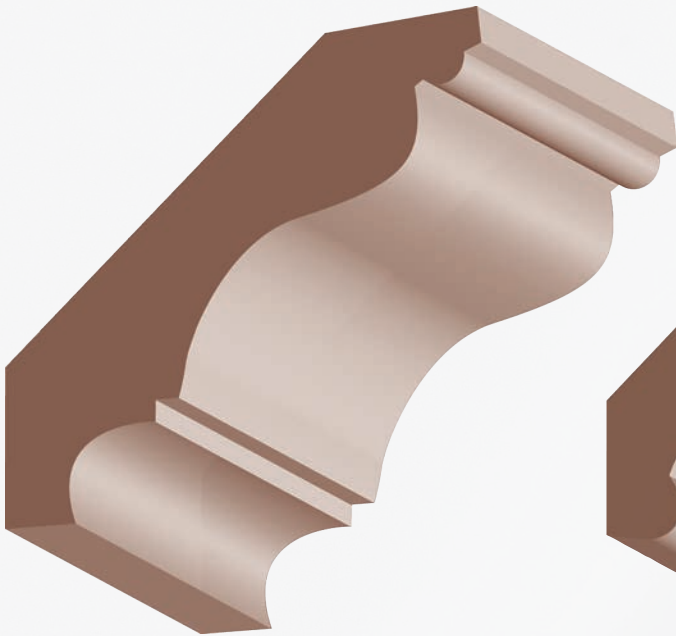

1/2 x 3-1/4 **Beaded Colonial Crown**
405BP Poplar **S**
405B-0 Oak **S**

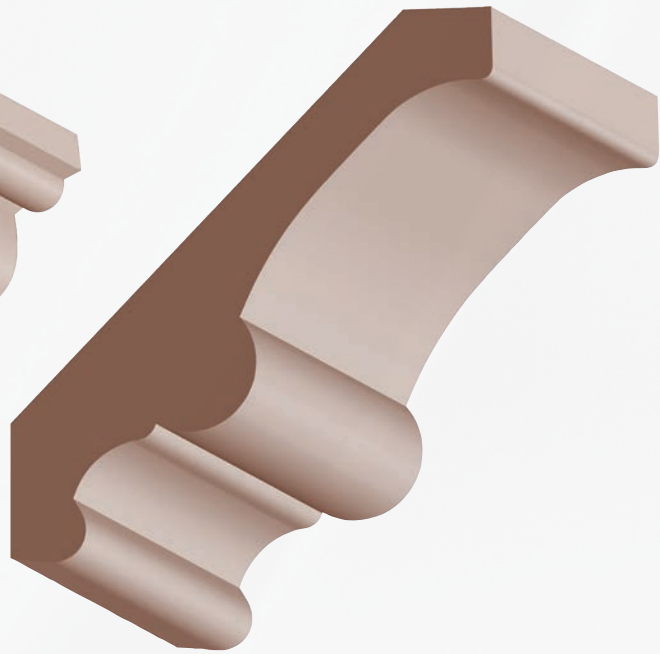

11/16 x 3-1/4 **Single Beaded Crown**
441P Poplar **N**

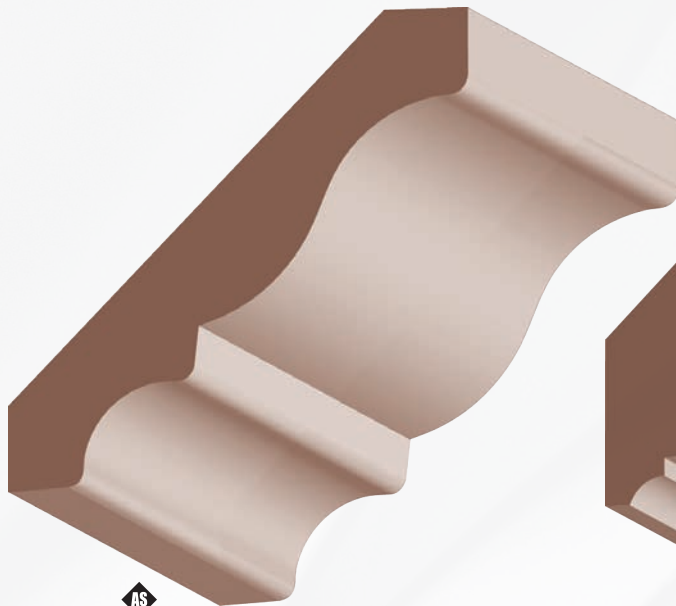

AS
 1/2 x 3-1/4 **Colonial Crown**
405P Poplar **N/S**
405-0 Oak **N/S**
405ALD Superior Alder **N/S**
405KA Knotty Alder **S**
405C Cherry **N/S**
405MH Mahogany **N/S**
405MP Maple **N/S**

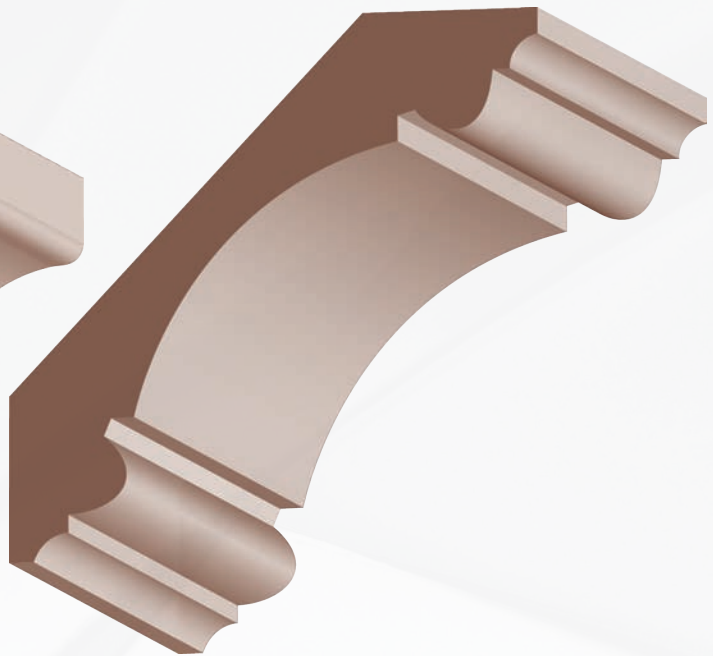

3/4 x 3-7/16 **Double Bead Carolina Crown**
421P Poplar **N**



(items are approximate scale only)

3-1/2" to 4-1/2" Crown

 lengths available: 6' thru 16'

AS
ALL SPECIES

AS*
ALL SPECIES
EXCEPT KNOTTY ALDER

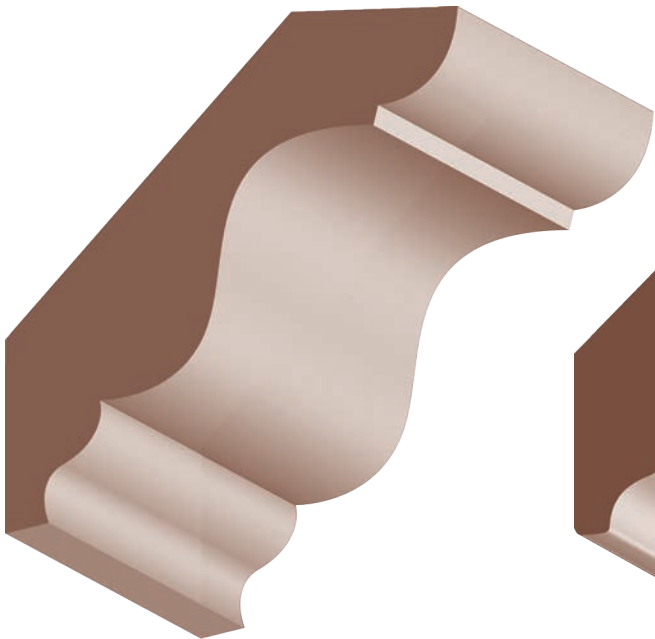

11/16 x 3-1/2 **Bed Mold**
CR820P Poplar *N/S*

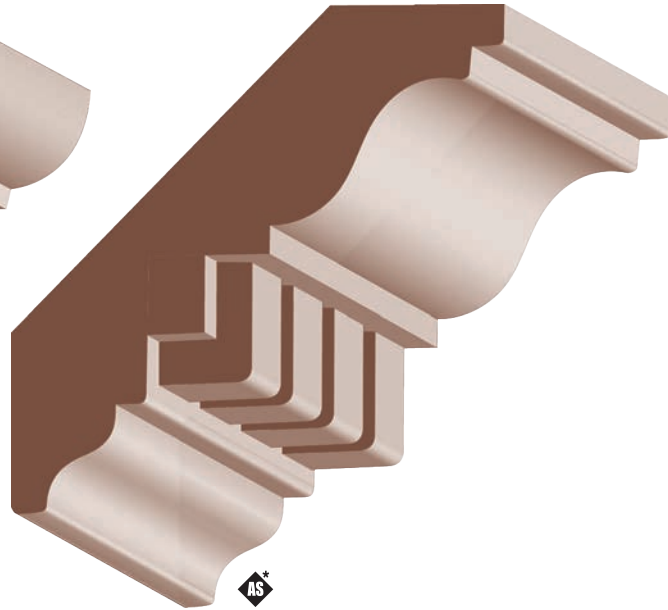

13/16 x 3-3/4 **Dentil Crown**

| | | | | | |
|----------------|----------------|------------|---------------|----------|------------|
| CM74P | Poplar | <i>N/S</i> | CM74C | Cherry | <i>N/S</i> |
| CM74-O | Oak | <i>N/S</i> | CM74MH | Mahogany | <i>N/S</i> |
| CM74ALD | Superior Alder | <i>N/S</i> | CM74MP | Maple | <i>N/S</i> |

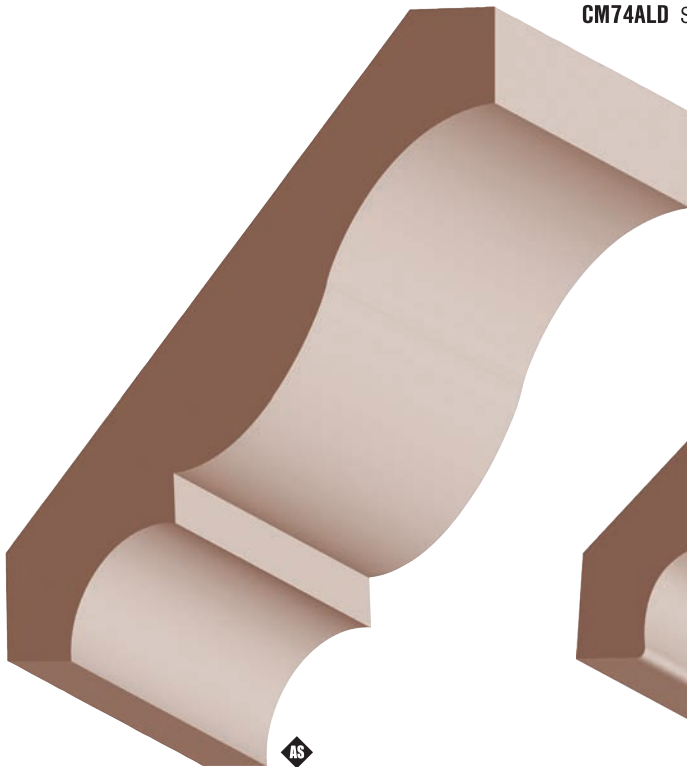

3/4 x 4-1/2 **Colonial Crown**

| | | |
|---------------|----------------|------------|
| 406P | Poplar | <i>N/S</i> |
| 406-O | Oak | <i>N/S</i> |
| 406ALD | Superior Alder | <i>N/S</i> |
| 406KA | Knotty Alder | <i>N/S</i> |
| 406C | Cherry | <i>N/S</i> |
| 406MH | Mahogany | <i>N/S</i> |
| 406MP | Maple | <i>N/S</i> |

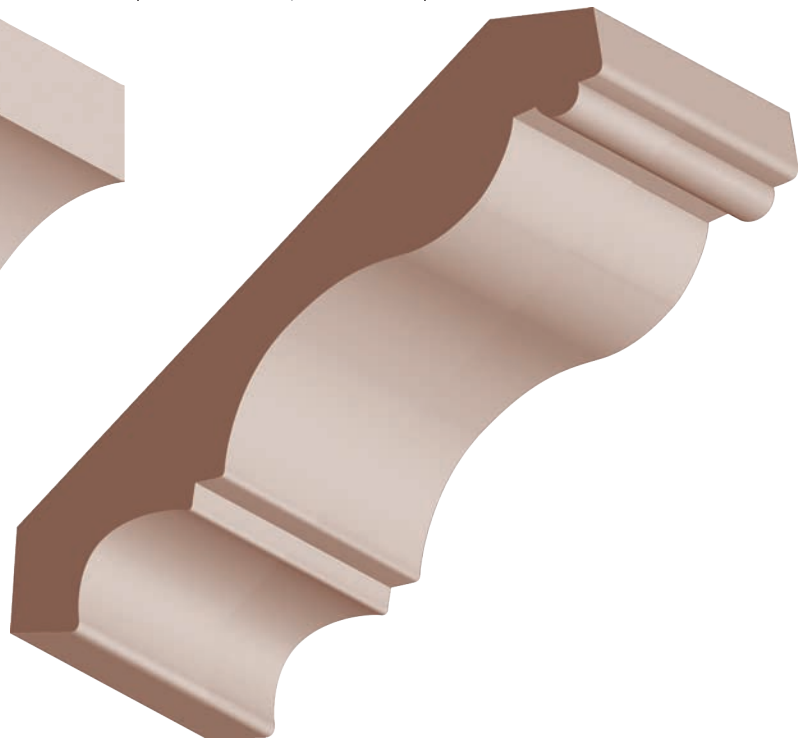

5/8 x 4-1/2 **Beaded Colonial Crown**

| | | |
|---------------|----------|----------|
| 406BP | Poplar | <i>S</i> |
| 406B-O | Oak | <i>S</i> |
| 406BC | Cherry | <i>S</i> |
| 406BMH | Mahogany | <i>S</i> |
| 406BMP | Maple | <i>S</i> |



4-1/2" to 4-5/8" Crown

(items are approximate scale only)

lengths available: 6' thru 16'

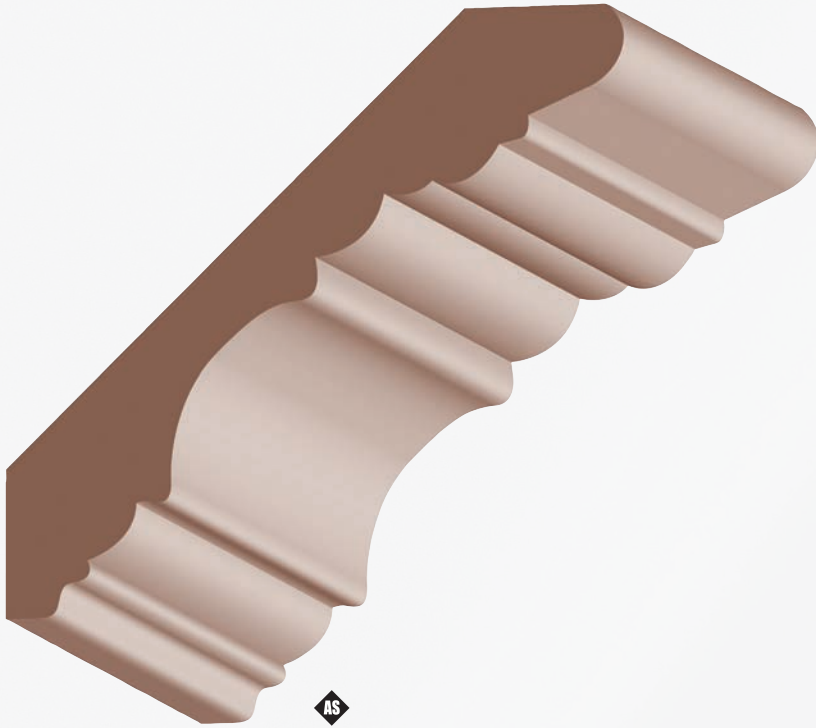

3/4 x 4-1/2 **Coronado/Georgian Crown**

| | | |
|---------------|----------------|-----|
| 412P | Poplar | N/S |
| 412-O | Oak | N/S |
| 412ALD | Superior Alder | N/S |
| 412KA | Knotty Alder | S |
| 412C | Cherry | N/S |
| 412MH | Mahogany | N/S |
| 412MP | Maple | N/S |

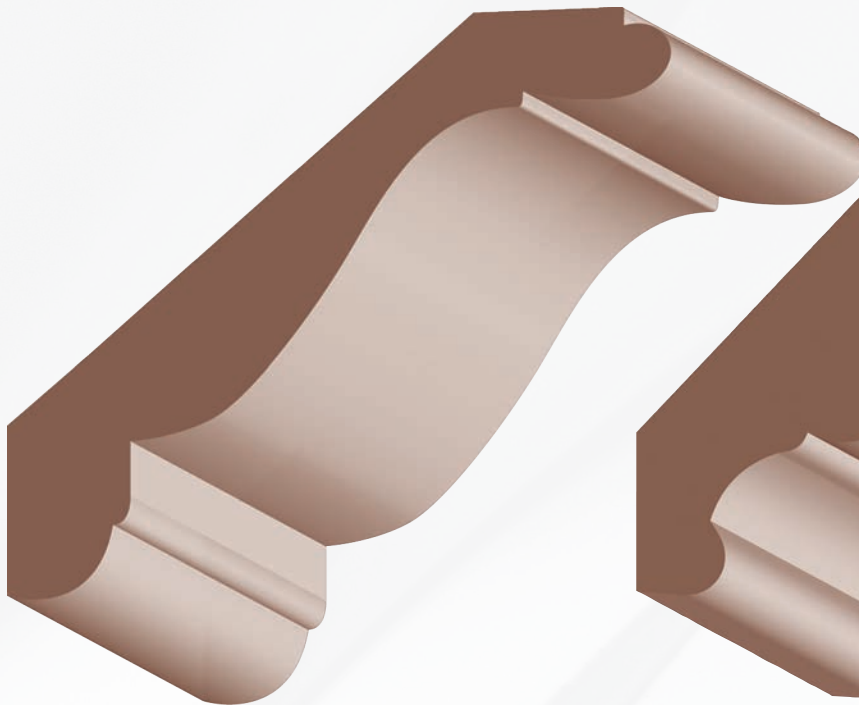

13/16 x 4-1/2 **Rancho Crown**
409-O Oak S

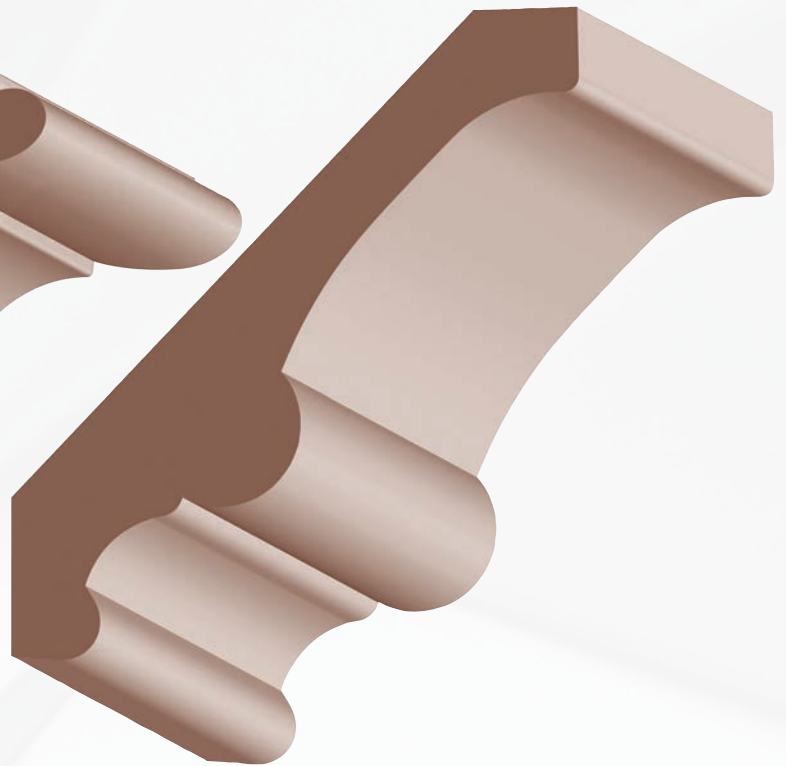

13/16 x 4-5/8 **Single Beaded Crown**
442P Poplar N



(items are approximate scale only)

4-5/8" to 5-1/4" Crown

lengths available: 6' thru 16'

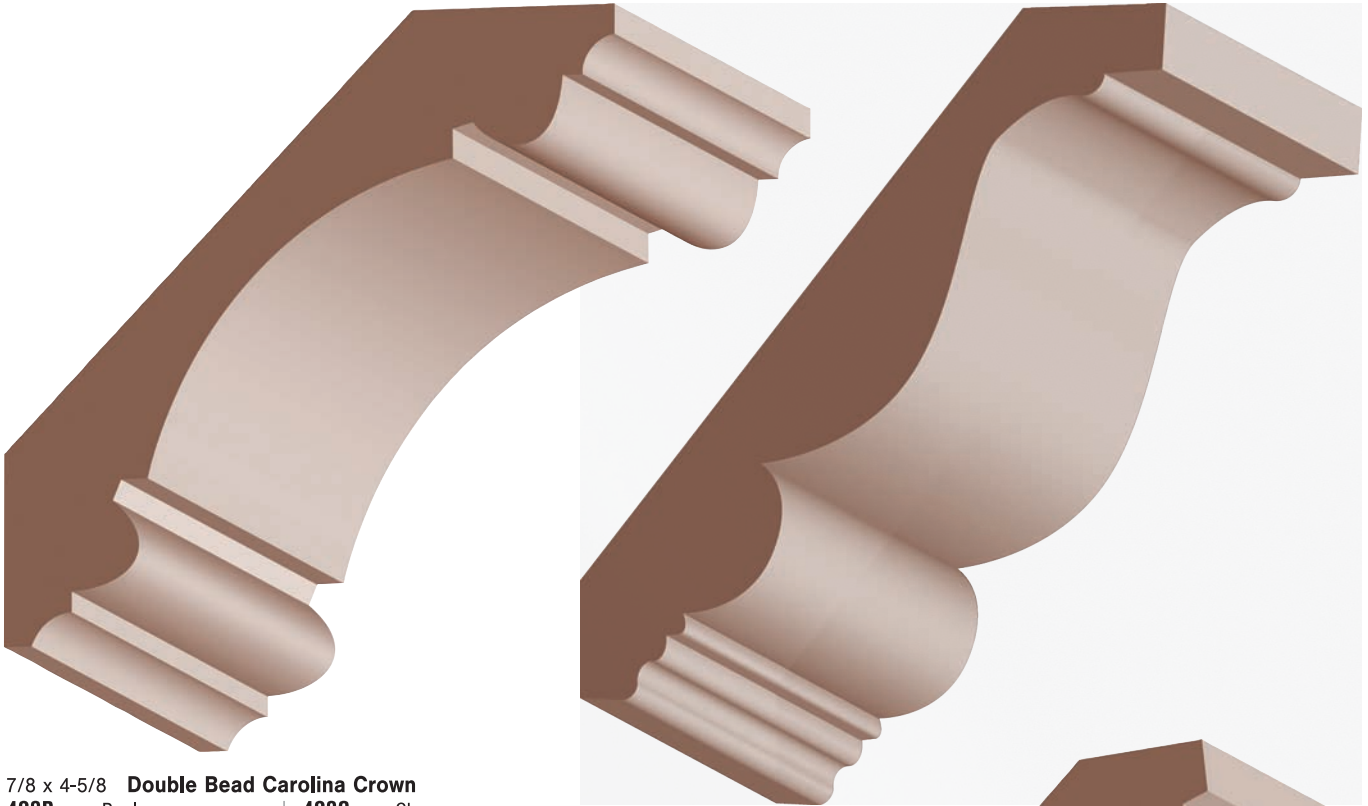

7/8 x 4-5/8 **Double Bead Carolina Crown**

| | | | | | |
|---------------|----------------|-----|--------------|----------|---|
| 423P | Poplar | N/S | 423C | Cherry | N |
| 423ALD | Superior Alder | N/S | 423MH | Mahogany | N |
| 423KA | Knotty Alder | N | 423MP | Maple | N |

11/16 x 4-3/4 **Imperial Crown**

| | | |
|---------------|--------|-----|
| CR810P | Poplar | N/S |
|---------------|--------|-----|

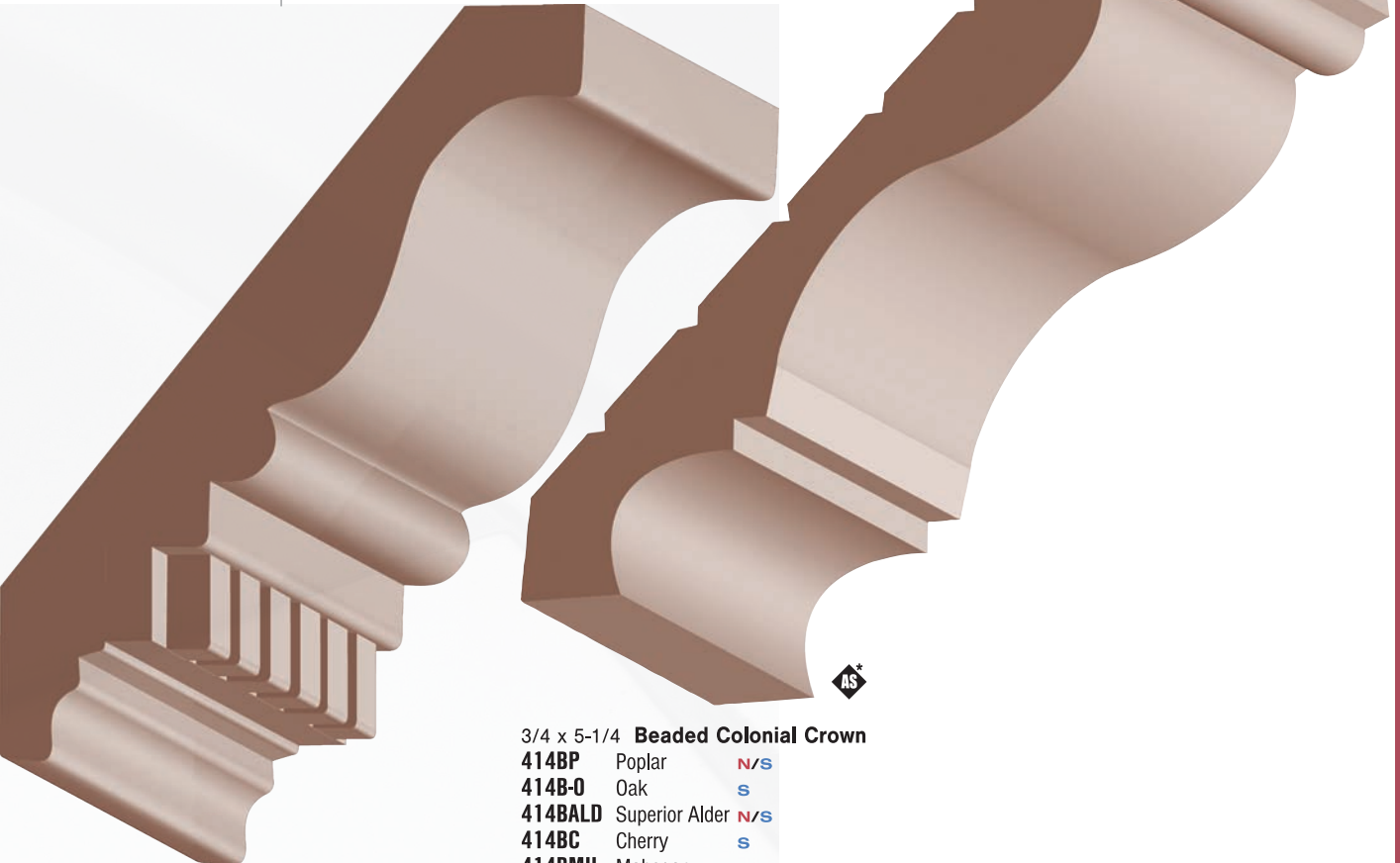

3/4 x 5 **Dentil Crown**

| | | |
|---------------|--------|---|
| CR864P | Poplar | S |
|---------------|--------|---|

3/4 x 5-1/4 **Beaded Colonial Crown**

| | | |
|----------------|----------------|-----|
| 414BP | Poplar | N/S |
| 414B-0 | Oak | S |
| 414BALD | Superior Alder | N/S |
| 414BC | Cherry | S |
| 414BMH | Mahogany | S |
| 414BMP | Maple | S |



5-1/4" to 5-1/2" Crown

(items are approximate scale only)

lengths available: 6' thru 16'

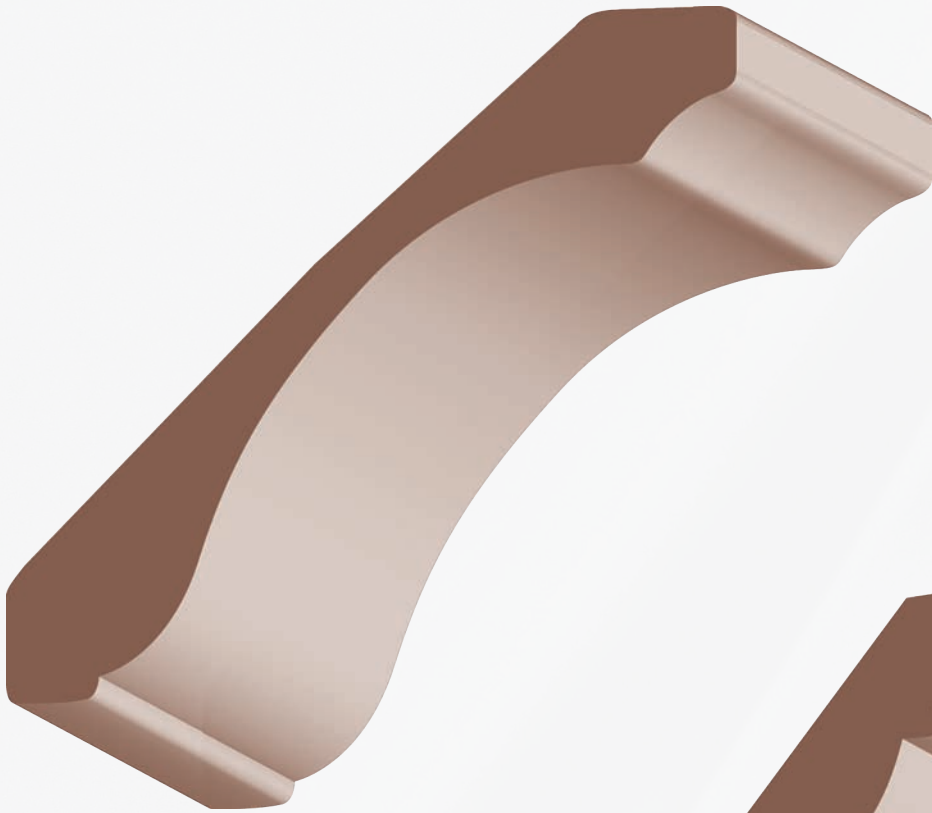

13/16 x 5-1/4 **Madison Crown**
C0705P Poplar [S](#)

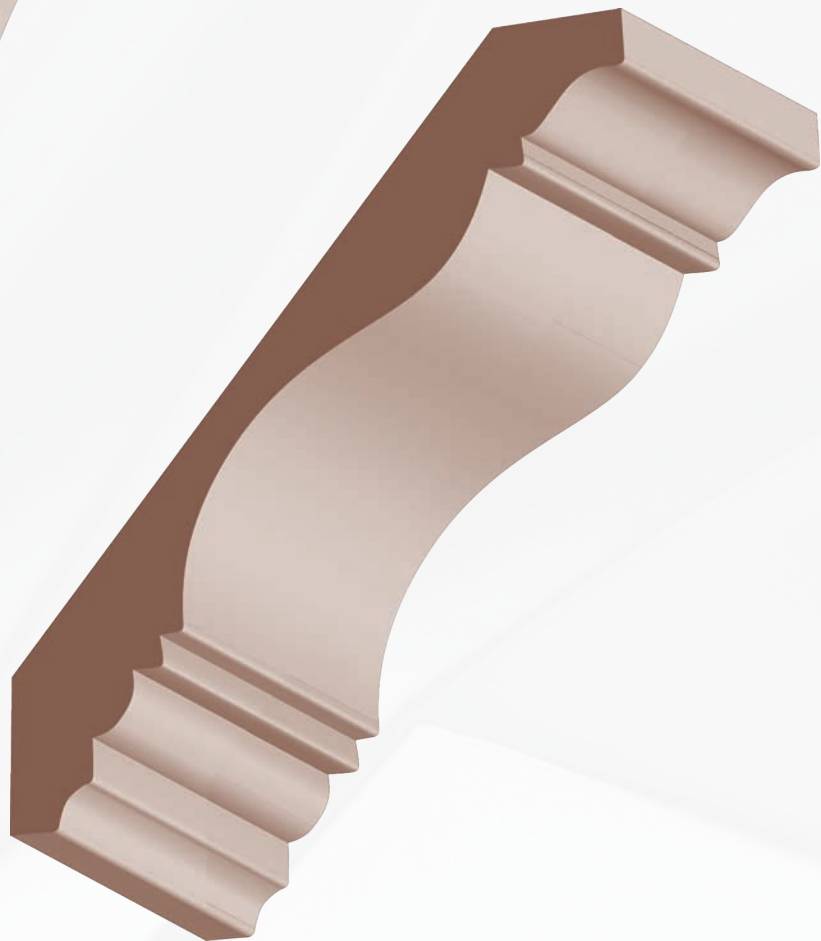

11/16 x 5-1/2 **Covington Crown**
CR806P Poplar [S](#)



(items are approximate scale only)

5-1/4" to 5-1/2" Crown

lengths available: 6' thru 16'

AS
ALL SPECIES

AS*
ALL SPECIES
EXCEPT KNOTTY ALDER

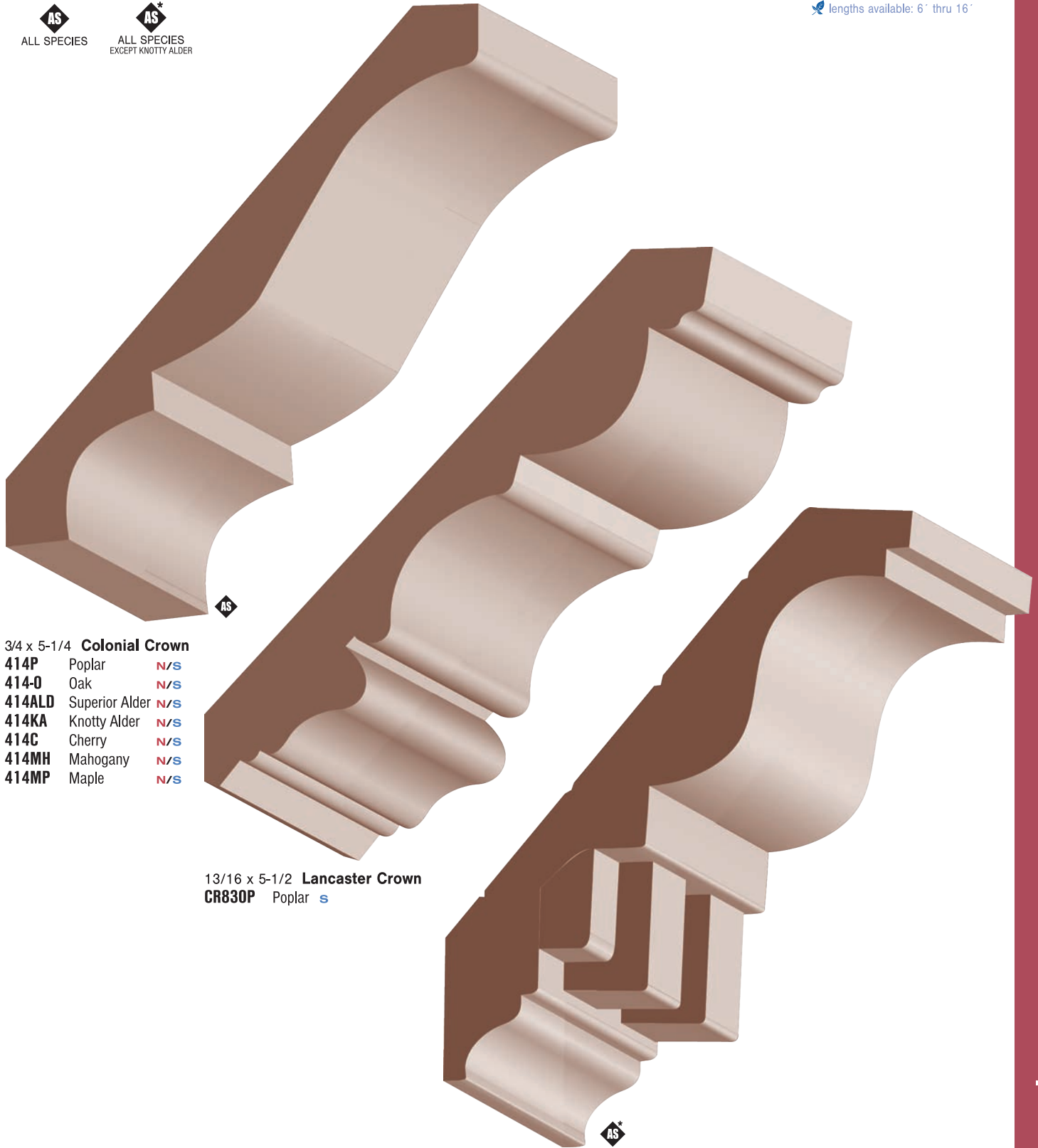

3/4 x 5-1/4 **Colonial Crown**

- 414P** Poplar N/S
- 414-O** Oak N/S
- 414ALD** Superior Alder N/S
- 414KA** Knotty Alder N/S
- 414C** Cherry N/S
- 414MH** Mahogany N/S
- 414MP** Maple N/S

13/16 x 5-1/2 **Lancaster Crown**
CR830P Poplar s

13/16 x 5-1/2 **Dentil Crown**

- CM73P** Poplar N/S
- CM73-O** Oak N/S
- CM73ALD** Superior Alder N/S
- CM73C** Cherry N/S
- CM73MH** Mahogany N/S
- CM73MP** Maple N/S



5-1/2" to 6" Crown

(items are approximate scale only)

✦ lengths available: 6' thru 16'

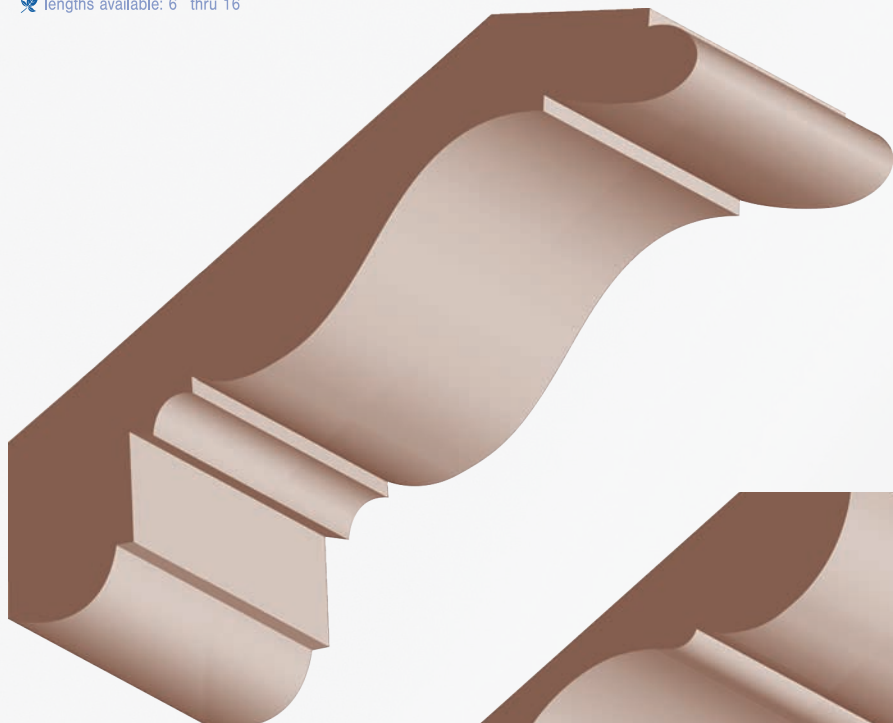

- 1-1/8 x 6 **Cornice**
- 408P Poplar \$
 - 408-O Oak \$
 - 408C Cherry N/S
 - 408MH Mahogany N/S
 - 408MP Maple N/S

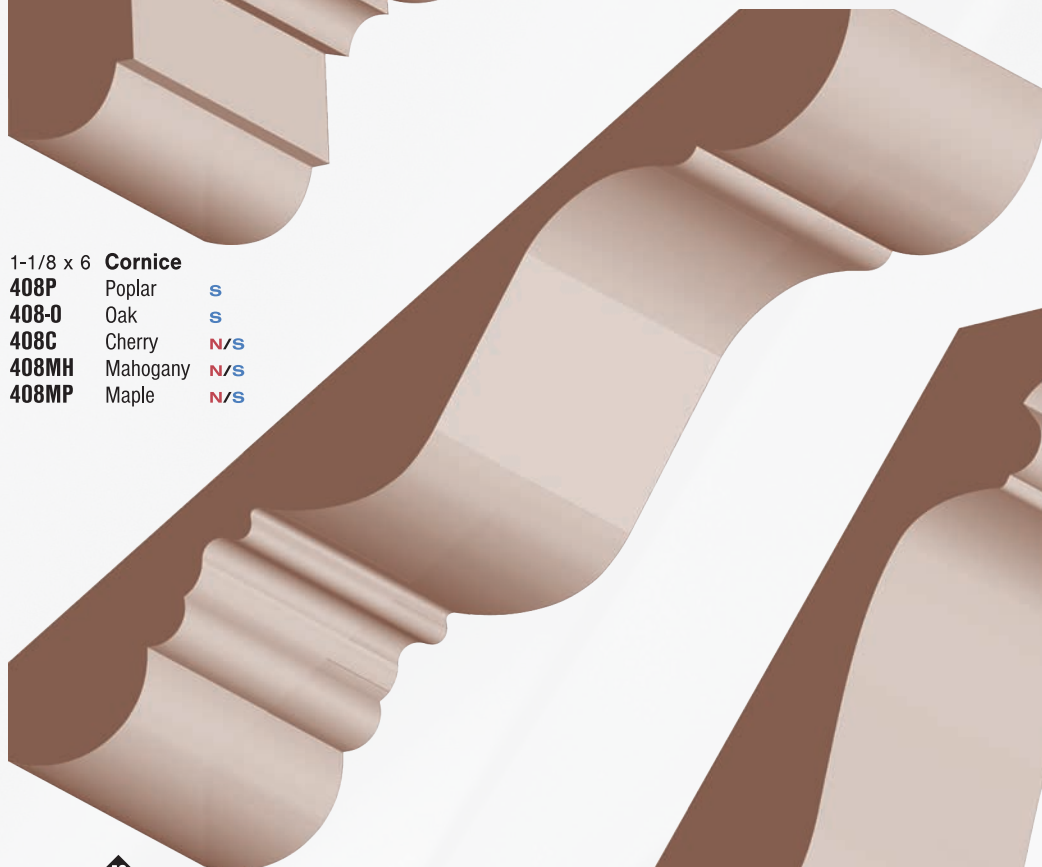

- 3/4 x 6 **Charleston Crown**
- 410P-6 Poplar N/S
 - 410-O6 Oak N/S
 - 410ALD-6 Superior Alder N/S
 - 410KA-6 Knotty Alder N/S
 - 410C-6 Cherry N/S
 - 410MH-6 Mahogany N/S
 - 410MP-6 Maple N/S

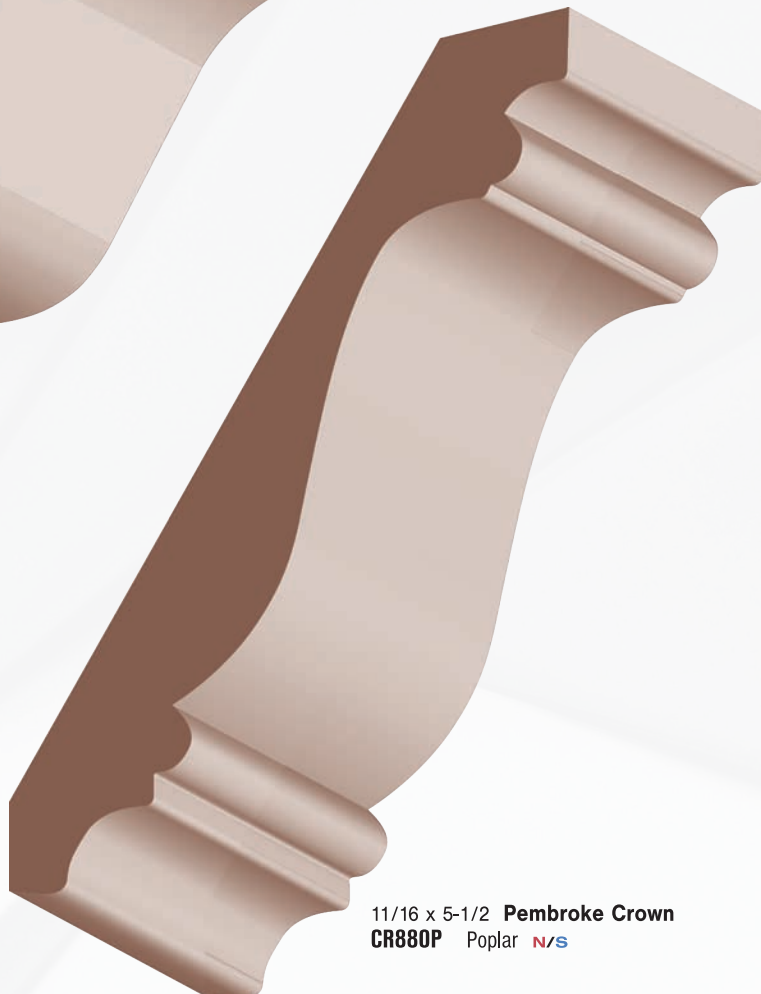

- 11/16 x 5-1/2 **Pembroke Crown**
CR880P Poplar N/S



(items are approximate scale only)

6-1/4" to 6-1/2" Crown

lengths available: 6' thru 16'

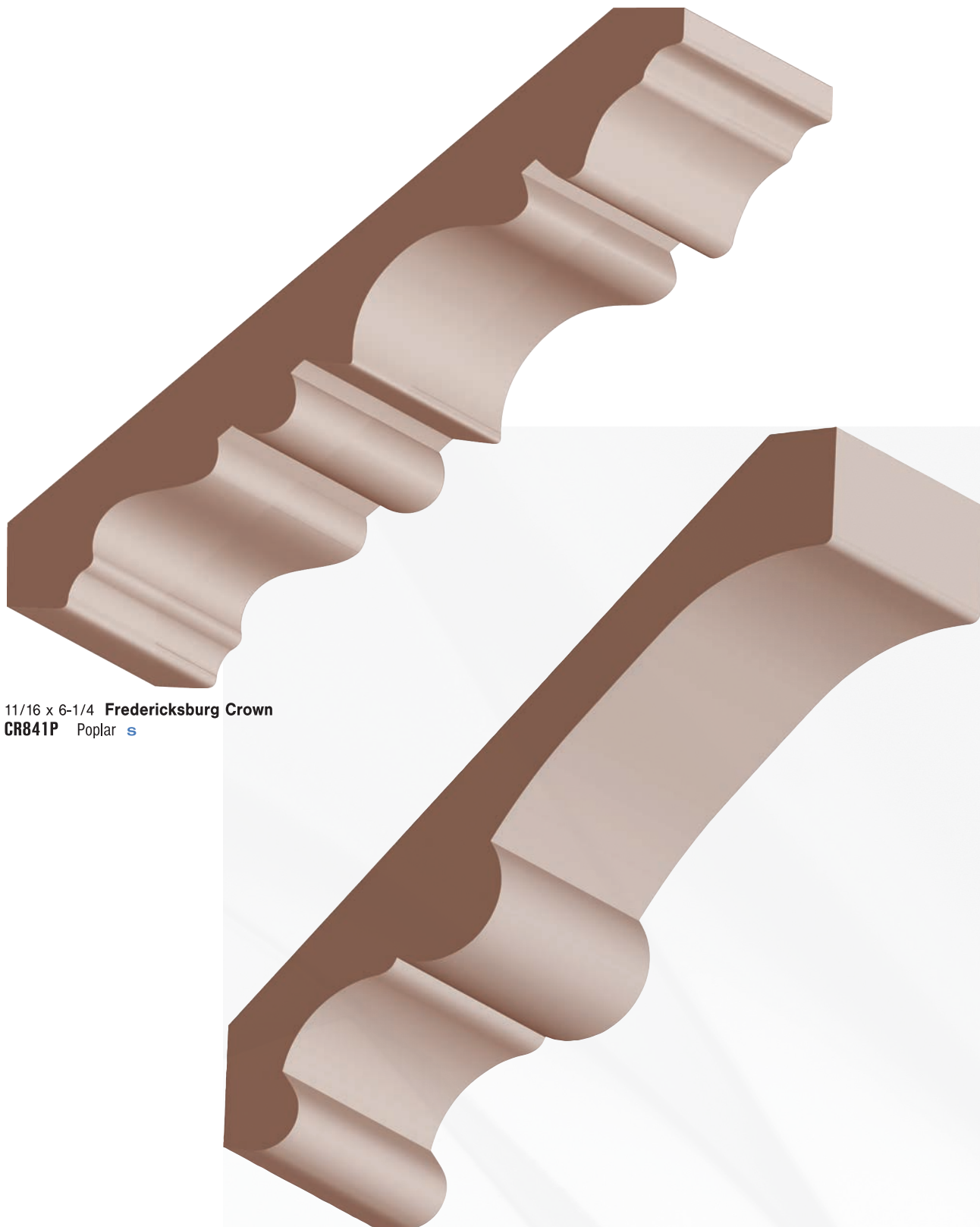

11/16 x 6-1/4 **Fredericksburg Crown**
CR841P Poplar **S**

7/8 x 6-1/2 **Single Beaded Crown**
443P Poplar **N**



6-1/2" Crown

lengths available: 6' thru 16'

(items are approximate scale only)

AS
ALL SPECIES
EXCEPT KNOTTY ALDER

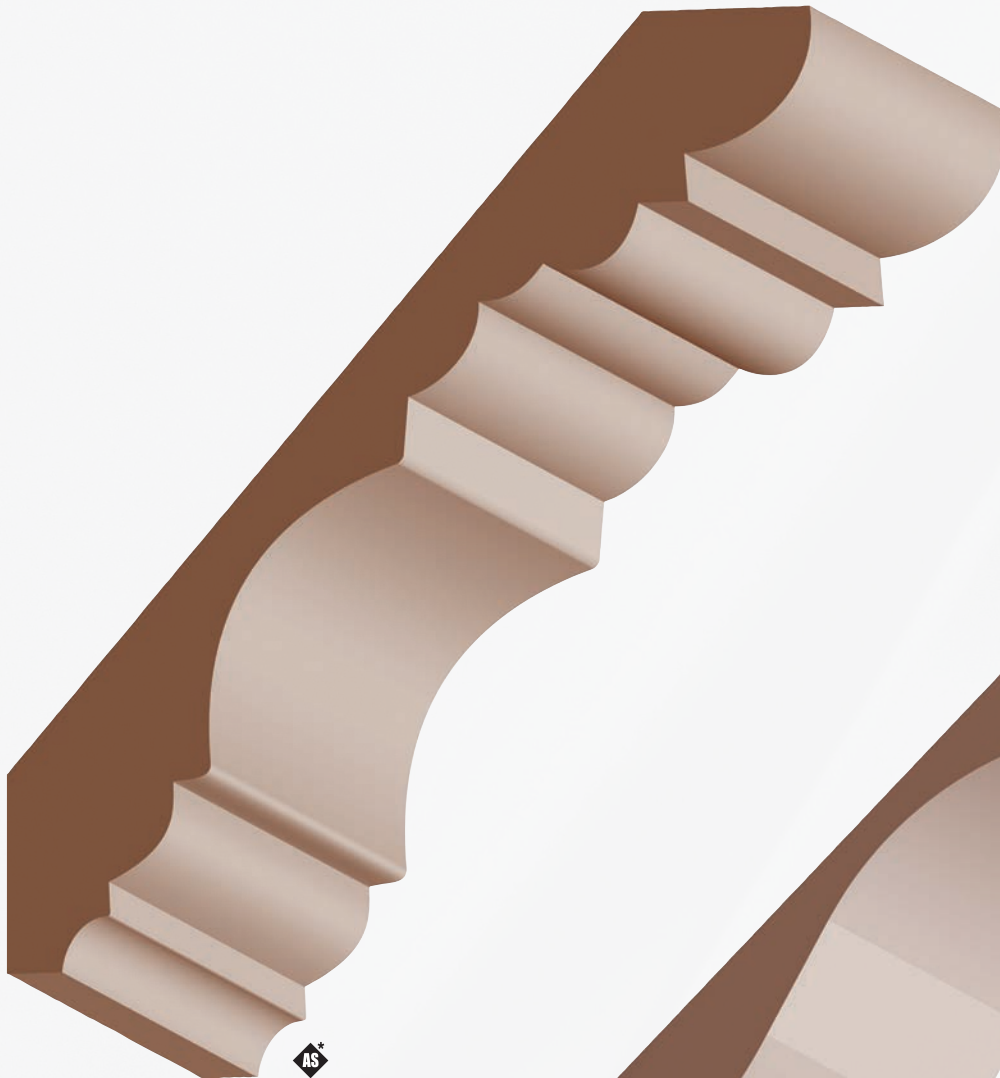

AS

7/8 x 6-1/2 **Coronado/Georgian Crown**

- 427P** Poplar N/S
- 427-O** Oak N/S
- 427ALD** Superior Alder N/S
- 427C** Cherry N/S
- 427MH** Mahogany N/S
- 427MP** Maple N/S

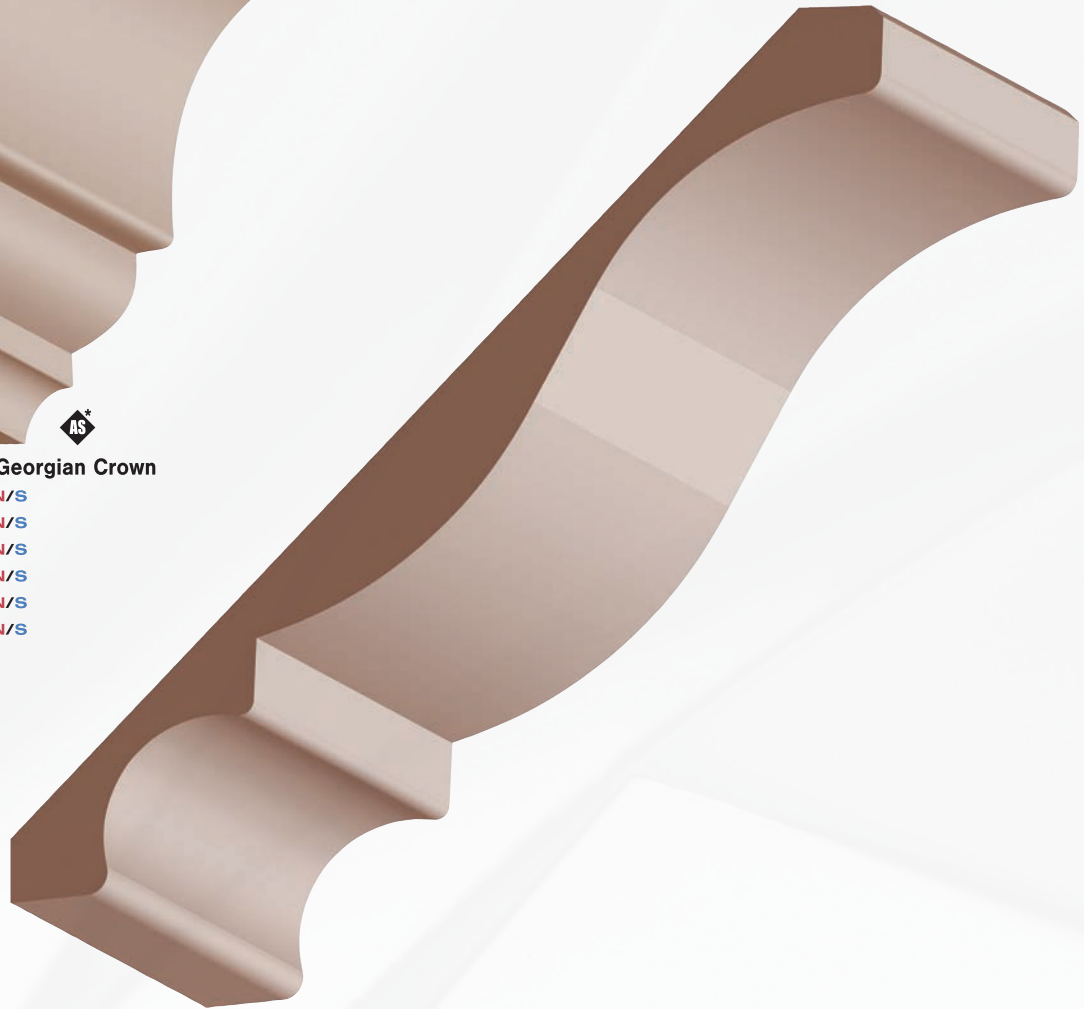

3/4 x 6-1/2 **Colonial Crown**
416P Poplar N/S



(items are approximate scale only)

6-1/2" to 6-7/8" Crown

lengths available: 6' thru 16'



AS
ALL SPECIES

AS

1-1/8 x 6-1/2 **Double Bead Carolina Crown**
(Not to Scale)

| | | |
|-----------------|----------------|-----|
| 424P-6 | Poplar | N/S |
| 424-O6 | Oak | N |
| 424ALD-6 | Superior Alder | N/S |
| 424KA-6 | Knotty Alder | N |
| 424C-6 | Cherry | N |
| 424MH-6 | Mahogany | N |
| 424MP-6 | Maple | N |

1-1/4 x 6-7/8 **Reale Crown**
456P Poplar N



7" Crown

lengths available: 6' thru 16'

(items are approximate scale only)

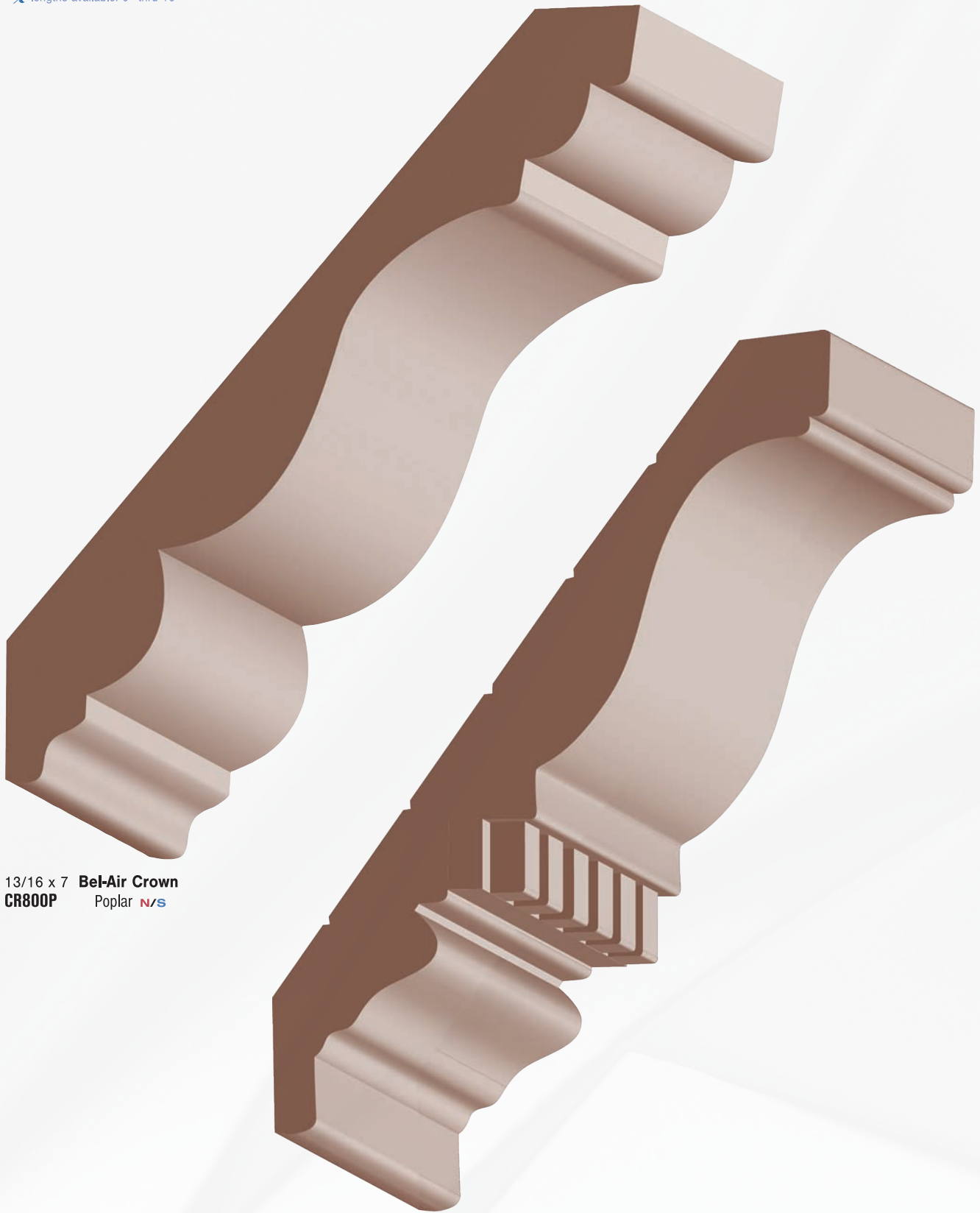

13/16 x 7 **Bel-Air Crown**
CR800P Poplar *N/S*

13/16 x 7 **Dentil Crown**
CR862P Poplar *N/S*
CR862-0 Oak *S*



(items are approximate scale only)

7-1/4" Crown

lengths available: 6' thru 16'

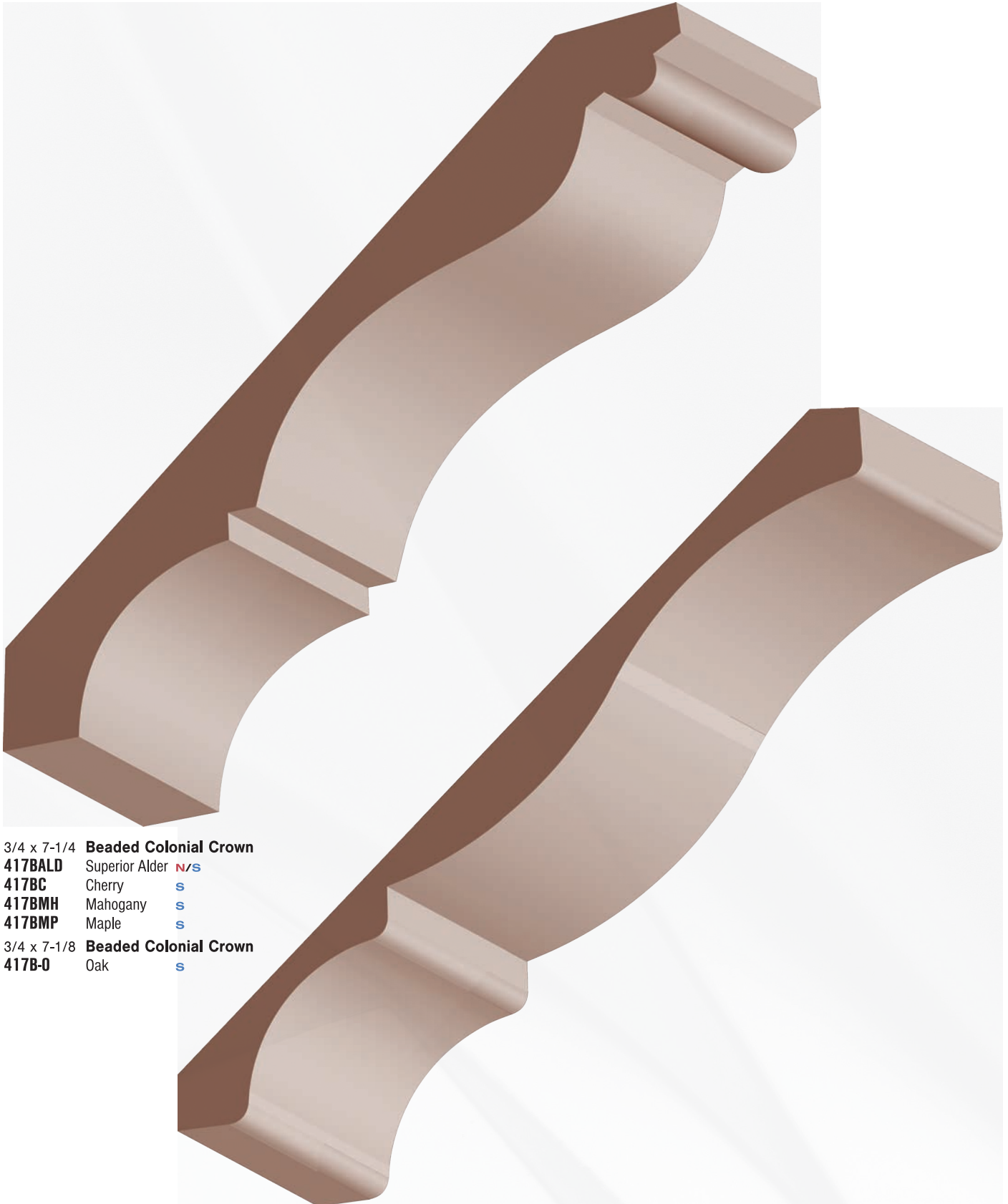

3/4 x 7-1/4 **Beaded Colonial Crown**

- 417BALD** Superior Alder N/S
- 417BC** Cherry S
- 417BMH** Mahogany S
- 417BMP** Maple S

3/4 x 7-1/8 **Beaded Colonial Crown**

- 417B-0** Oak S

3/4 x 7-1/4 **Colonial Crown**

- 417P** Poplar N/S
- 417ALD** Superior Alder S



8" to 9-5/8" Crown

(items are approximate scale only)

lengths available: 6' thru 16'

1 x 8 Charleston Crown

- 410P-8** Poplar N/S
- 410C-8** Cherry S
- 410MH-8** Mahogany S
- 410MP-8** Maple S

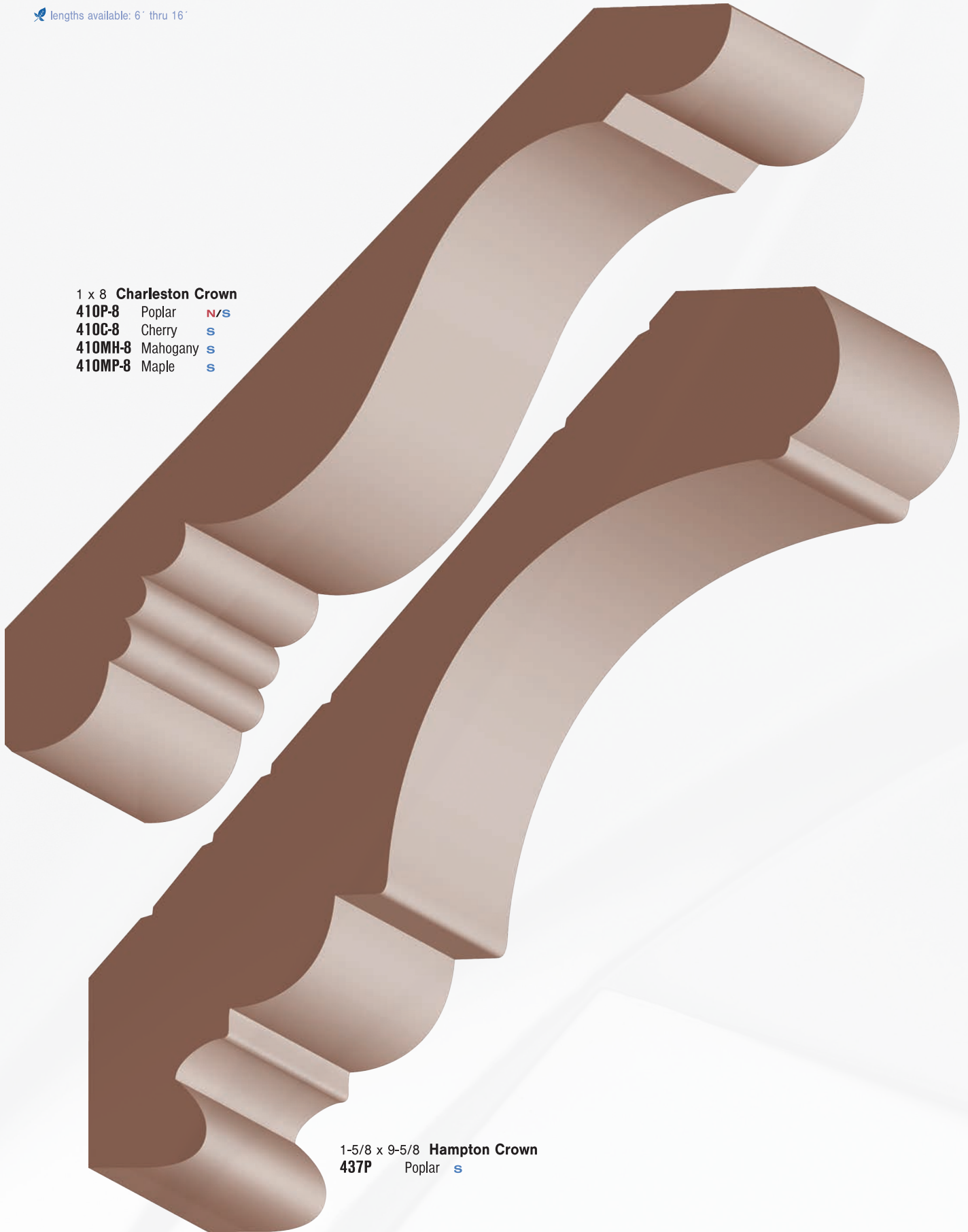

1-5/8 x 9-5/8 Hampton Crown

- 437P** Poplar S



(items are approximate scale only)

Dentil Lineal

lengths available: 6' through 16'

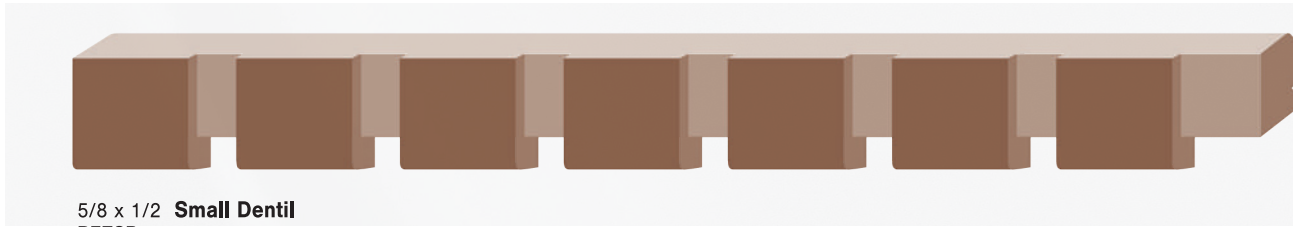

5/8 x 1/2 **Small Dentil**
DE73P Poplar **N/S**



1/2 x 1/2 **Dentil**
DE168P Poplar **S**



15/16 x 5/8 **Large Dentil**
DE74P Poplar **N/S**



3/4 x 1 **Dentil**
DE169P Poplar **S**



5/8 x 1-1/2 **Dentil**
DE170P Poplar **S**

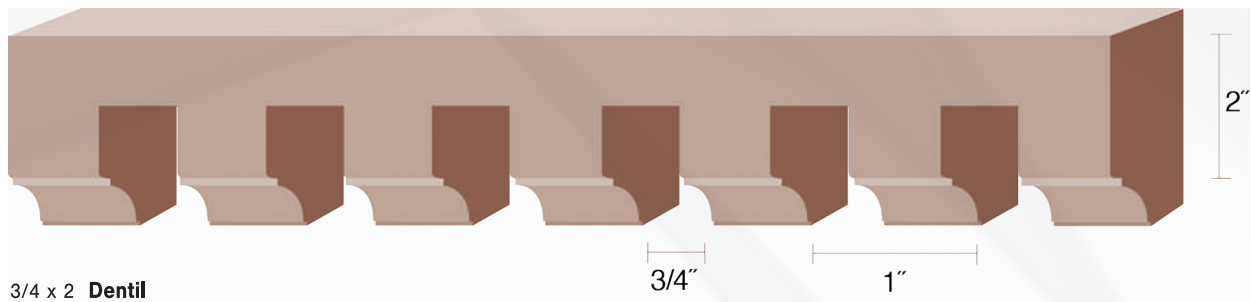

3/4 x 2 **Dentil**
DE171P Poplar **S**
DE171-O Oak **S**

Screen & Pencil Molds

lengths available: 6" through 16"

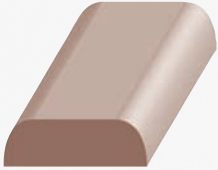

1/4 x 3/4 Flat Screen Mold
591P Poplar *N/S*
591-0 Oak *N/S*



3/16 x 3/4 Scribe Mold **AS***
593P Poplar *N/S* **593C** Cherry *N/S*
593-0 Oak *N/S* **593MH** Mahogany *N/S*
593ALD Superior Alder *N/S* **593MP** Maple *N/S*

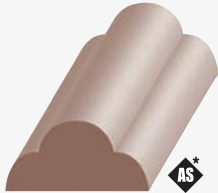

3/8 x 3/4 Cloverleaf **AS***
594P Poplar *N/S*
594-0 Oak *N/S*
594ALD Superior Alder *N/S*
594C Cherry *N/S*
594MH Mahogany *N/S*
594MP Maple *N/S*

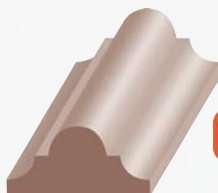

3/8 x 3/4 Bead Mold **NEW**
598P Poplar *N*

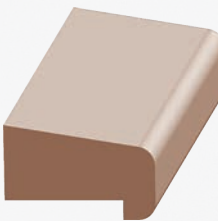

1/2 x 7/8 Beveled Full-Lip Bead **NEW**
580-0 Oak *S*
580MP Maple *S*



3/4 x 3/4 Pencil Mold **NEW**
680P Poplar *N*



3/8 x 11/16 Flush Bead **NEW**
581-0 Oak *S*
581MP Maple *S*



3/4 x 1-1/16 Flat Full-Lip Bead **NEW**
582-0 Oak *S*
582MP Maple *S*



1/2 x 23/32 Beveled Flush Bead **NEW**
583-0 Oak *S*
583MP Maple *S*

Cove

(items are approximate scale only)

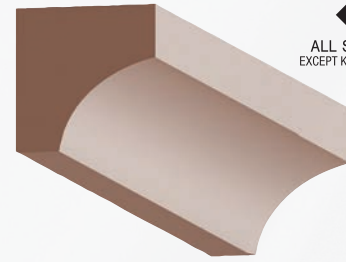

AS*
 ALL SPECIES
 EXCEPT KNOTTY ALDER

3/4 x 3/4 Cove **AS***

523P Poplar *N/S* **523C** Cherry *N/S*
523-0 Oak *N/S* **523MH** Mahogany *N/S*
523ALD Superior Alder *N/S* **523MP** Maple *N/S*

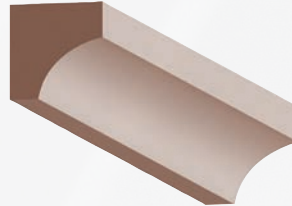

1/2 x 1/2 Cove **AS***

521P Poplar *N/S*
521-0 Oak *S*
521ALD Superior Alder *N/S*
521C Cherry *N/S*
521MH Mahogany *N/S*
521MP Maple *N/S*

Quarter / Half / Full Round

lengths available: 6" through 16"



1/2 x 1/2 Quarter Round
502P Poplar *N/S*
502-0 Oak *N/S*
502C Cherry *N/S*
502MH Mahogany *N/S*
502MP Maple *N/S*



3/8 x 3/4 Half Round
572P Poplar *N/S*
572-0 Oak *N/S*
572C Cherry *N/S*
572MH Mahogany *N/S*
572MP Maple *N/S*

3/4 x 3/4 Quarter Round **AS***

504P Poplar *N/S*
504-0 Oak *N/S*
504ALD Superior Alder *N/S*
504C Cherry *N/S*
504MH Mahogany *N/S*
504MP Maple *N/S*

3/4 x 1-1/2 Half Round

575P Poplar *N/S*
1 x 2 Half Round
576P Poplar *N/S*

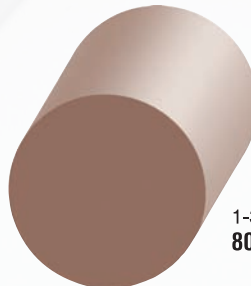

1-3/8 Full Round
803-0 Oak *N/S*



(items are approximate scale only)

Panel Mold & Cap

lengths available: 6' thru 16'



ALL SPECIES
EXCEPT KNOTTY ALDER

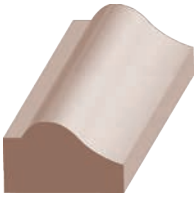

3/8 x 5/8 **Panel Mold**
600-0 Oak **S**

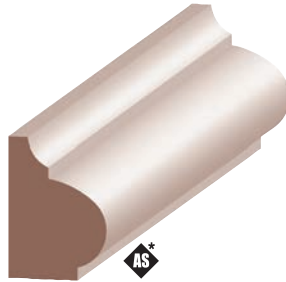

9/16 x 3/4 **Base Cap**

| | | | |
|------------------------------|----------|-----------------------|----------|
| 612P Poplar | N | 612C Cherry | N |
| 612-0 Oak | N | 612MH Mahogany | N |
| 612ALD Superior Alder | N | 612MP Maple | N |

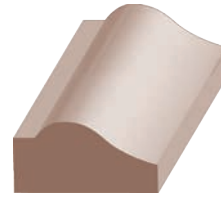

5/8 x 3/4 **Panel Mold**
601-0 Oak **S**

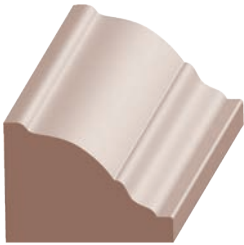

5/8 x 7/8 **Mantel Panel Mold**
635P Poplar **S**
635-0 Oak **S**

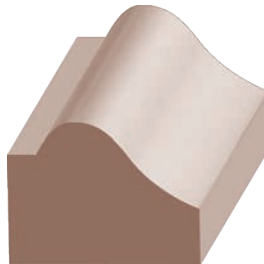

3/4 x 1 **Panel Mold**
602-0 Oak **N/S**
602ALD Superior Alder **N/S**

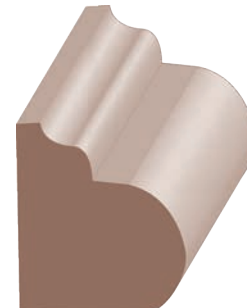

7/8 x 1 **Panel Mold**

| | | | |
|------------------------------|----------|-----------------------|----------|
| 630P Poplar | S | 630C Cherry | S |
| 630-0 Oak | S | 630MH Mahogany | S |
| 630ALD Superior Alder | S | 630MP Maple | S |

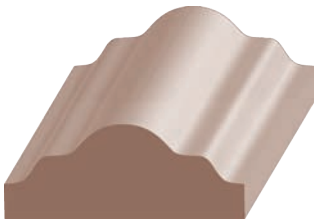

1/2 x 1-1/4 **Panel Mold**
629P Poplar **S**

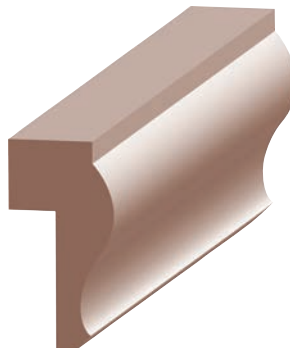

9/16 x 1-1/8 **Panel Cap**
[with 3/4" Rab't]
624-0 Oak **N**

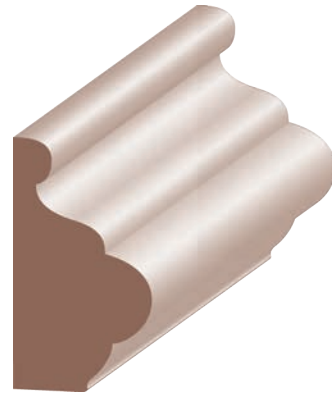

3/4 x 1-5/16 **Panel Mold**

| | | | |
|------------------------------|----------|-----------------------|----------|
| 631P Poplar | S | 631C Cherry | S |
| 631-0 Oak | S | 631MH Mahogany | S |
| 631ALD Superior Alder | S | 631MP Maple | S |

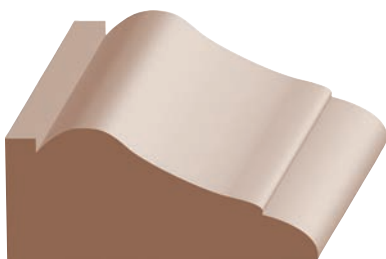

3/4 x 1-5/8 **Panel Mold**
605-0 Oak (11/16 x 1-5/8) **S**
605ALD Superior Alder **N/S**

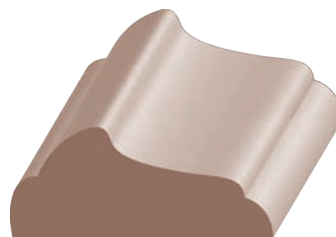

9/16 x 1-3/8 **Panel Mold**
606-0 Oak **S**

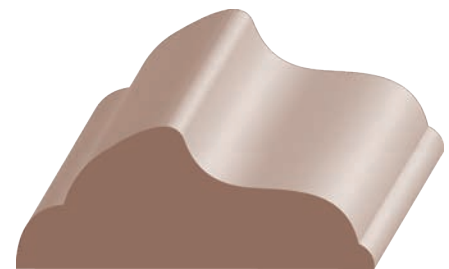

3/4 x 1-7/8 **Beauty Mold**
608-0 Oak **S**



Panel Cap

lengths available: 6' thru 16'

(items are approximate scale only)

AS*
ALL SPECIES
EXCEPT KNOTTY ALDER

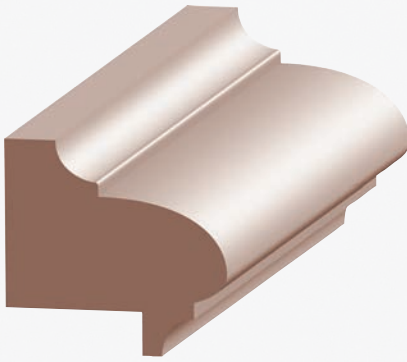

1-1/8 x 1-3/16 **Panel Cap**
[with 3/4" Rab't]

623P Poplar **N**

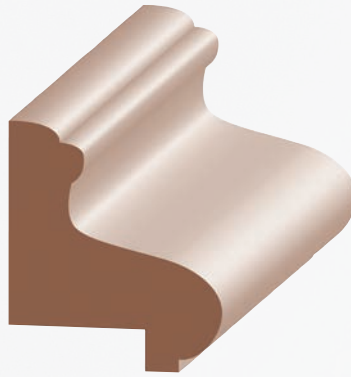

1-1/8 x 1-1/4 **Raised Panel Cap**
[with 3/4" Rab't]

613-0 Oak **N/S**
613P Poplar **S**

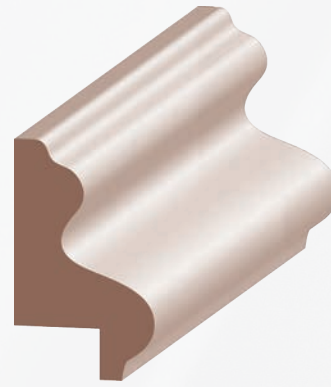

3/4 x 1-1/4 **Raised Panel Cap** **AS***
[with 1/2" Rab't]

| | |
|---------------------------------------|--------------------------------|
| 632P Poplar S | 632C Cherry S |
| 632-0 Oak S | 632MH Mahogany S |
| 632ALD Superior Alder S | 632MP Maple S |

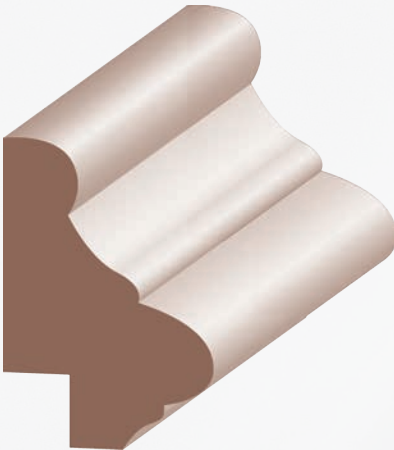

1-1/8 x 1-5/8 **Panel Cap**
[with 3/8" Rab't]

732-0 Oak **S**

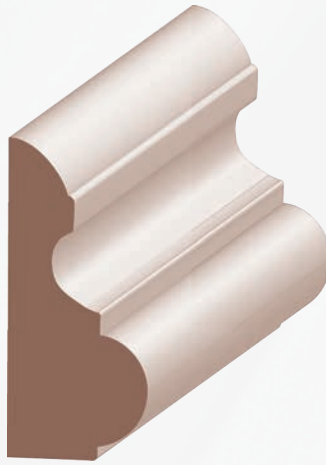

3/4 x 1-11/16 **Base Cap**

625P Poplar **S**

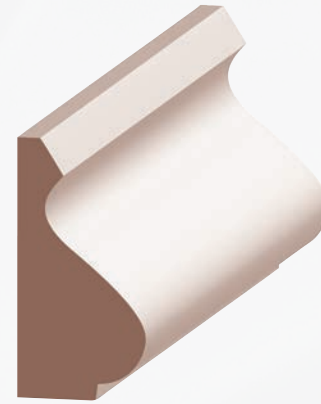

11/16 x 1-3/8 **Coronado Base Cap** **AS***

| | |
|---------------------------------------|----------------------------------|
| 614P Poplar N/S | 614C Cherry N/S |
| 614-0 Oak N/S | 614MH Mahogany N/S |
| 614ALD Superior Alder N | 614MP Maple N/S |

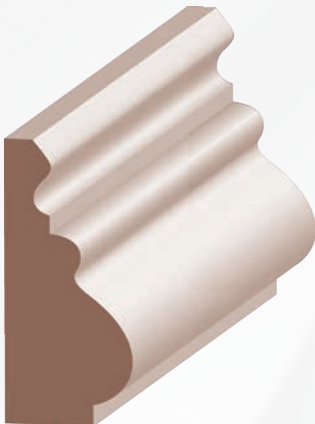

11/16 x 1-1/2 **Decorative Base Cap**

628P Poplar **S**
628-0 Oak **S**
628C Cherry **S**
628MH Mahogany **S**
628MP Maple **S**

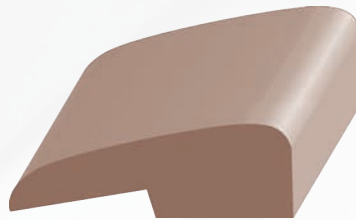

1/2 x 1-1/2 **Panel Cap**

[with 1/4" Rab't]
730-0 Oak **S**

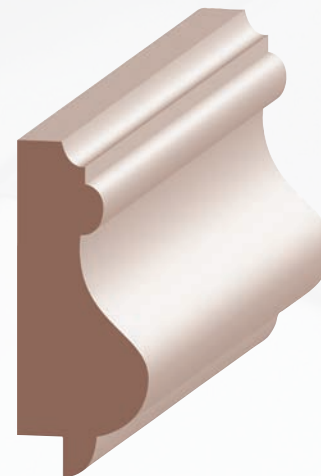

11/16 x 1-3/4 **Panel Cap**
[with 1/4" Rab't]

616P Poplar **N/S**



(items are approximate scale only)

Panel Mold / Cap

lengths available: 6' thru 16'

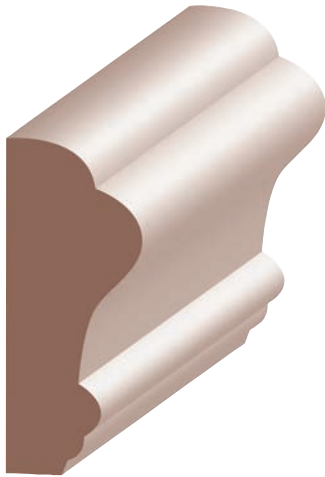

11/16 x 1-3/4 **Panel Cap**
617P Poplar *N/S*

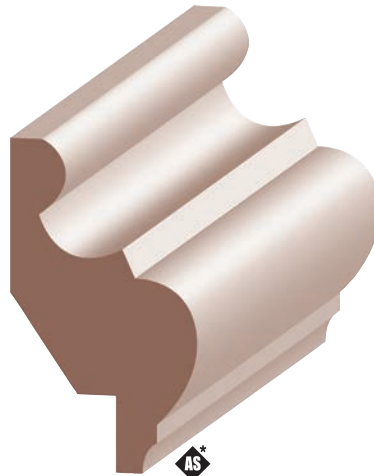

3/4 x 1-3/4 **Panel Cap**
[with 1/2" Rab't]

- 620P Poplar *N/S*
- 620-O Oak *N/S*
- 620ALD Superior Alder *N/S*
- 620C Cherry *N/S*
- 620MH Mahogany *N/S*
- 620MP Maple *N/S*

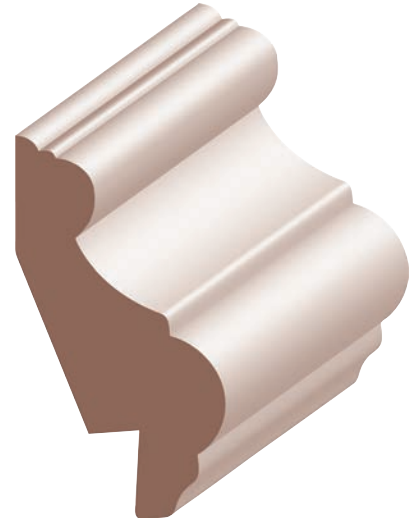

1-1/8 x 2 **Panel Cap**
[with 1/2"-5/8" Rab't]

- 615P Poplar *N/S*

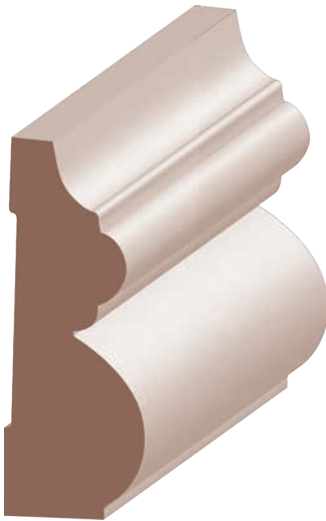

3/4 x 2 **Panel Mold**
618P Poplar *S*

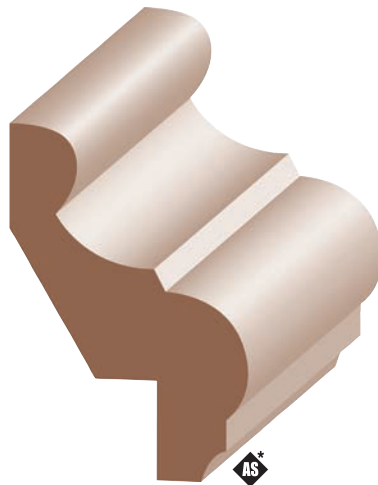

13/16 x 2 **Panel Cap** [with 3/4" Rab't]
621ALD Superior Alder *N/S*

- 3/4 x 2 **Panel Cap** [with 3/4" Rab't]
- 621P Poplar *N/S*
- 621-O Oak *N/S*
- 621C Cherry *N/S*
- 621MP Maple *N/S*
- 621MH Mahogany *N/S*



Panel Cap

lengths available: 6' thru 16'

(items are approximate scale only)

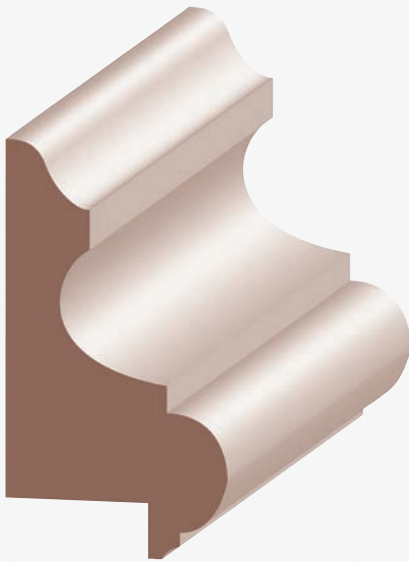

1-3/16 x 2-3/16 **Raised Panel Cap**
[with 3/4" Rab't]
611P Poplar **N**



9/16 x 2-1/4 **Wainscot Cap**
[with 3/8" Rab't]
729BP Poplar **N**

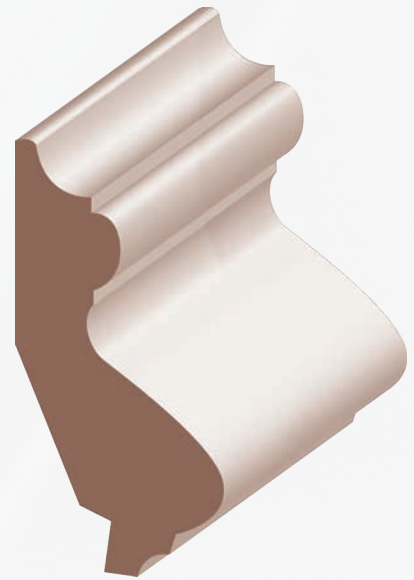

11/16 x 2-3/8 **Panel Cap**
[with 9/16" Rab't]
619P Poplar **S**



3/4 x 2-5/16 **Panel Cap**
[with 1/4" Rab't]
622P Poplar **S**

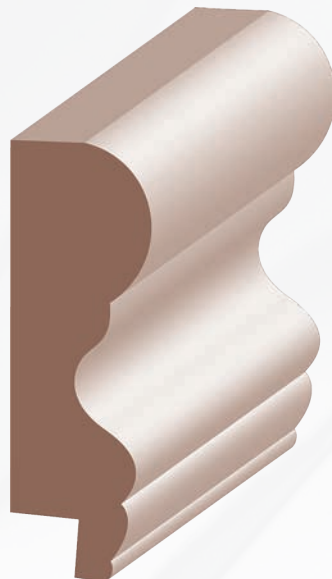

3/4 x 2-5/16 **T&G Cap**
[with 1/4" Rab't]
622ALD Superior Alder **N/S**



(items are approximate scale only)

Chair Rail

lengths available: 6' thru 16'

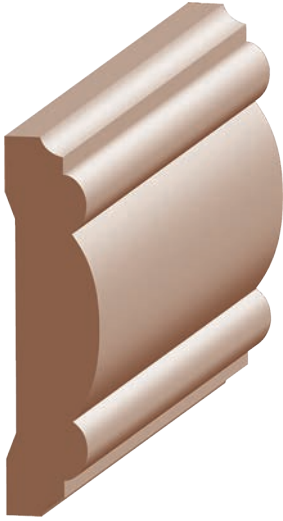

1/2 x 2 **Bead & Barrel Chair Rail**
648P Poplar **S**
648-0 Oak **S**



1/2 x 2-1/2 **Chair Rail**
651-0 Oak **N/S**



5/8 x 2-5/8 **Colonial Chair Rail**
655P Poplar **N**
655-0 Oak **N/S** [FORMERLY 652-0]



13/16 x 2-5/8 **Chair Rail**
 [with 3/8" Rab't]
659P Poplar **N**
659-0 Oak **N**

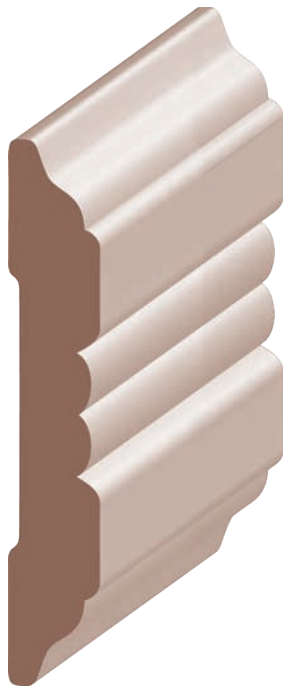

1/2 x 2-7/8 **Beaded Chair Rail**
658-0 Oak **S**



3/4 x 3 **Bead & Barrel Chair Rail**
649P Poplar **N/S**
649ALD Superior Alder **S**

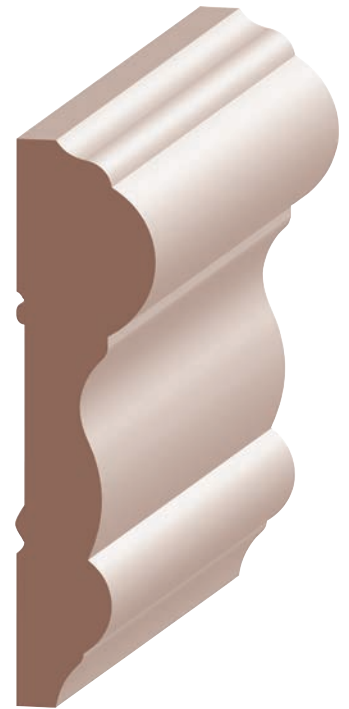

3/4 x 3 **Colonial Chair Rail**
653P Poplar **S**
653-0 Oak **N/S**
653C Cherry **N/S**
653MH Mahogany **N/S**
653MP Maple **N/S**



Chair Rail

lengths available: 6' thru 16'

(items are approximate scale only)



3/4 x 3 **Chair Rail**
[with 1/2" Rab't]
654P Poplar **S**

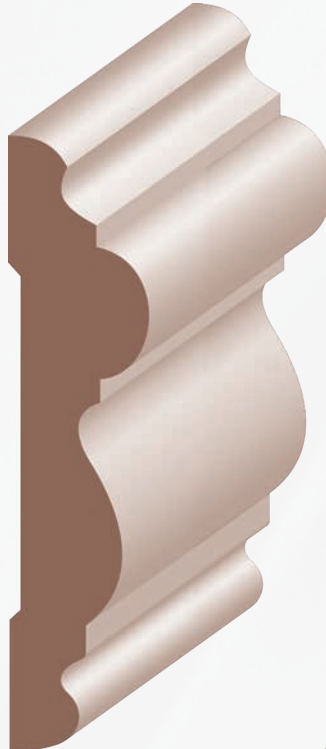

3/4 x 3-1/4 **Chair Rail**
656P Poplar **S**

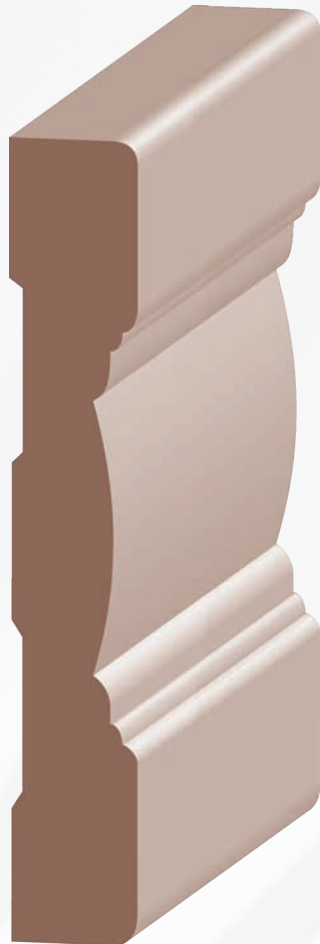

1 1/16 x 4-1/4 **Victorian Casing/Chair Rail**
184-0 Oak **S**

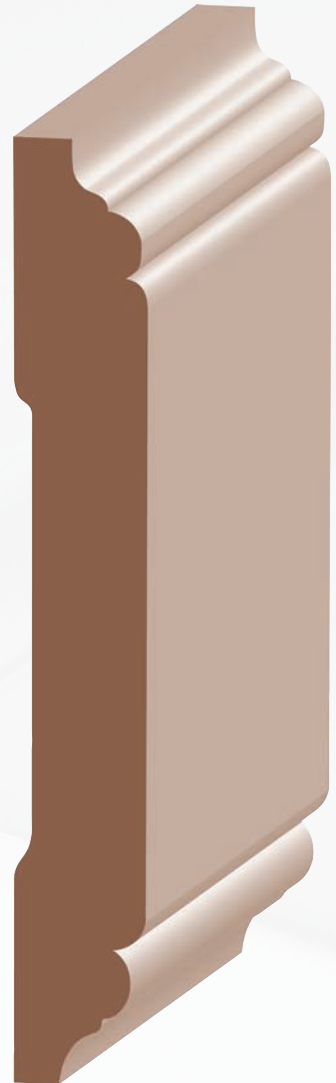

1 1/16 x 5 **Chair Rail**
693P Poplar **N**



(items are approximate scale only)

T&G Wainscot

lengths available: 6' thru 16'



3/8 x 3-3/8 **Reversible Beaded/Flat T&G Wainscot**

- R2000P** Poplar N/S
- R2000-0** Oak (3/8 x 3-1/2) N/S
- R2000ALD** Superior Alder N/S

BEADED

FLAT



5/16 x 3-3/8 **Beaded Shiplap T&G**

- 2003ALD** Superior Alder N/S

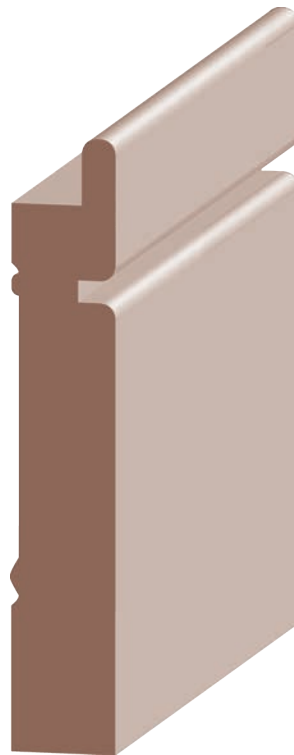

9/16 x 3-1/4 **Wainscot Base**

[with 3/8" Rab't]

- 735P** Poplar S

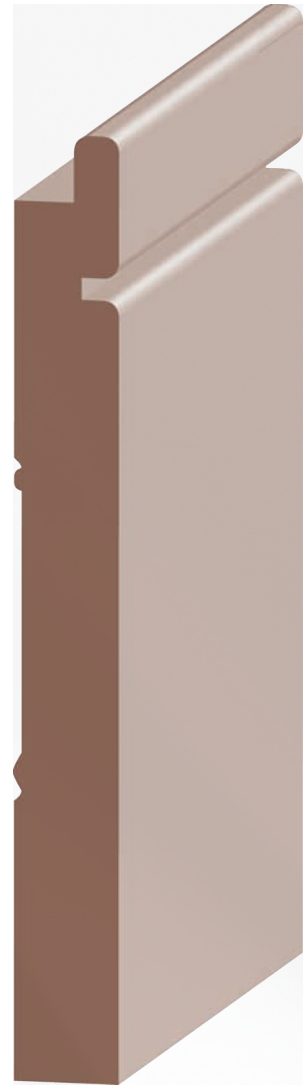

9/16 x 5 **T&G Wainscot Base**

[with 3/8" Rab't]

- 736ALD** Superior Alder N/S



Astragal

lengths available: 6' thru 12'

(items are approximate scale only)

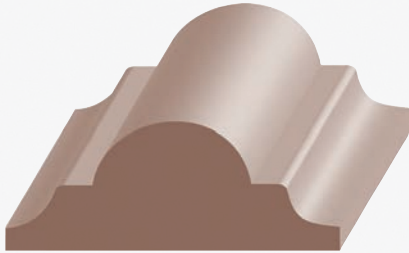

3/4 x 1-5/8 **Flat Astragal/Panel Mold**

| | | |
|---------------|----------------|---|
| 646P | Poplar | N |
| 646-O | Oak | N |
| 646ALD | Superior Alder | N |
| 646C | Cherry | N |

| | | |
|---------------|----------------|---|
| 660P | Poplar | S |
| 660-O | Oak | S |
| 660ALD | Superior Alder | S |
| 660C | Cherry | S |
| 660MH | Mahogany | S |
| 660MP | Maple | S |

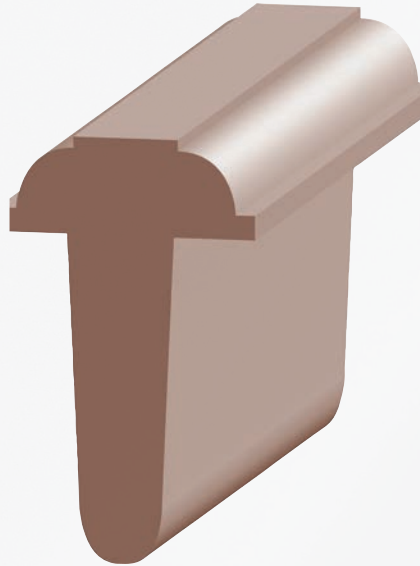

1-1/4 x 2-1/4 **T-Astragal for 1-3/4" Doors**

| | | |
|---------------|----------------|-----|
| 661P | Poplar | N/S |
| 661-O | Oak | N/S |
| 661ALD | Superior Alder | N/S |
| 661C | Cherry | N/S |
| 661MH | Mahogany | N/S |

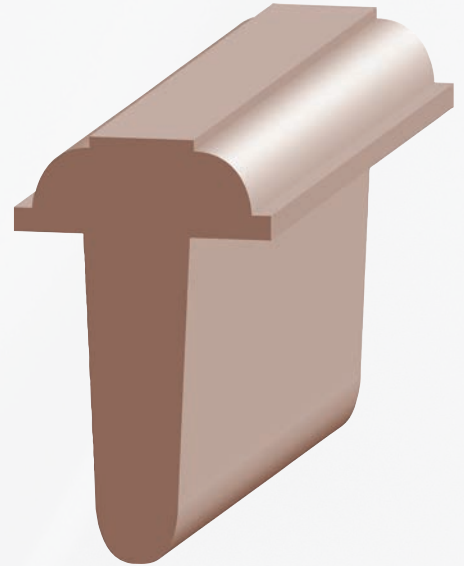

1-1/4 x 2 **T-Astragal for 1-3/8" Doors**

| | | |
|---------------|----------------|-----|
| 662-O | Oak | N/S |
| 662ALD | Superior Alder | N/S |
| 662C | Cherry | N |

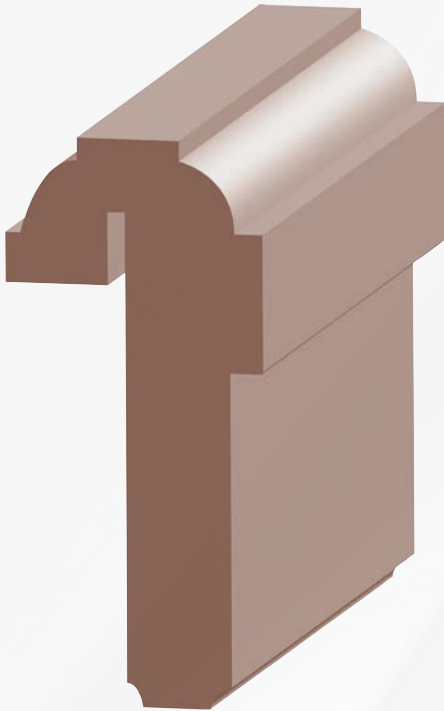

1-3/8 x 3 **T-Astragal w/Weatherstrip Kerf for 1-3/4" Doors**

| | | |
|---------------|----------------|-----|
| 663P | Poplar | N/S |
| 663-O | Oak | N/S |
| 663ALD | Superior Alder | N/S |
| 663C | Cherry | N/S |
| 663MH | Mahogany | N/S |

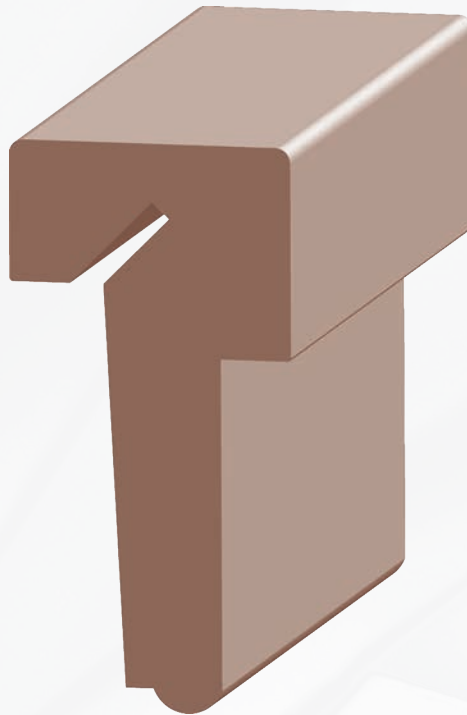

1-1/2 x 3-1/8 **T-Astragal w/Weatherstrip Kerf**

| | | |
|---------------|------------------------|-----|
| 667P | Poplar | N/S |
| 667MH | Mahogany | N/S |
| 667WL | Walnut | N/S |
| 667QWO | Quarter Sawn White Oak | N/S |

1-5/8 x 3 **Thick T-Astragal w/Weatherstrip Kerf for 1-3/4" Doors**

| | | |
|----------------|----------------|---|
| 663BP | Poplar | S |
| 663B-O | Oak | S |
| 663BALD | Superior Alder | S |
| 663BMH | Mahogany | S |



(items are approximate scale only)



Exterior Mold

lengths available: 6' through 16'

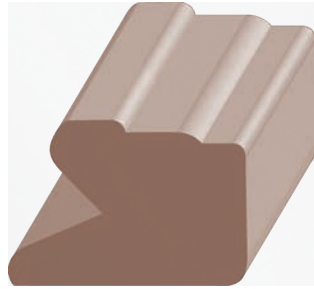

7/8 x 1-1/4 **Stucco Mold**

| | | |
|---------------|----------------|---|
| 826-0 | Oak | S |
| 826ALD | Superior Alder | S |
| 826MH | Mahogany | S |

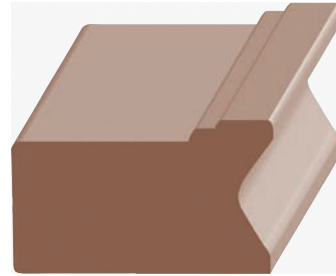

13/16 x 1-3/8 **Stucco Mold**

| | | |
|---------------|----------------|---|
| 833-0 | Oak | N |
| 833ALD | Superior Alder | N |
| 833C | Cherry | N |
| 833MH | Mahogany | N |

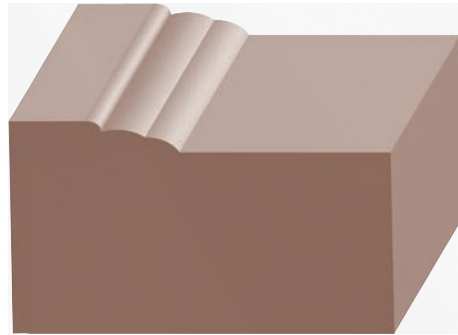

1-1/8 x 2 **#180 Eastern Brick Mold without Stucco Key**

| | | |
|----------------|----------------|-----|
| 612A-0 | Oak | N/S |
| 612AALD | Superior Alder | N/S |
| 612AC | Cherry | N/S |
| 612AMH | Mahogany | N/S |



1-1/8 x 2 **#180 Eastern Brick Mold w/Stucco Key**

| | | |
|----------------|----------------|-----|
| 612B-0 | Oak | N/S |
| 612BALD | Superior Alder | N/S |
| 612BC | Cherry | N/S |
| 612BMH | Mahogany | N/S |

Outside Corner Guard

lengths available: 6' thru 16'



3/4 x 3/4 **Outside Corner Guard**
720-0 Oak N/S



1 x 1 **Outside Corner Guard**

| | | |
|---------------|----------------|-----|
| 721P | Poplar | N/S |
| 721-0 | Oak | N/S |
| 721ALD | Superior Alder | N/S |
| 721C | Cherry | N/S |
| 721MH | Mahogany | N/S |
| 721MP | Maple | N/S |

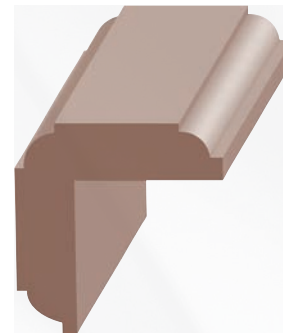

1-1/8 x 1-1/8 **Detail Outside Corner Guard**

| | | |
|--------------|----------|-----|
| 723P | Poplar | N/S |
| 723-0 | Oak | N/S |
| 723C | Cherry | N/S |
| 723MH | Mahogany | N/S |
| 723MP | Maple | N/S |



Handrail

(items are approximate scale only)

lengths available: 6' thru 16'

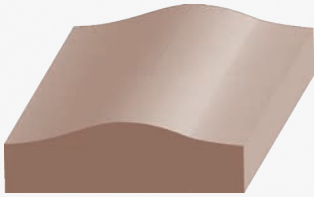

3/8 x 1-1/4 **Fillet**
951P Poplar **S**
951-0 Oak **S**



3/4 x 2-1/2 **Shoe Rail**
w/ 1/4" x 1-1/4" Plow
950P Poplar **S**
950-0 Oak **S**

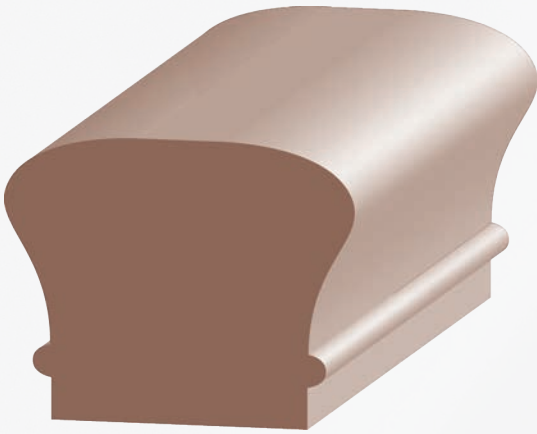

1-1/2 x 1-7/8 **Small #6010 Handrail**
932P Poplar **S**

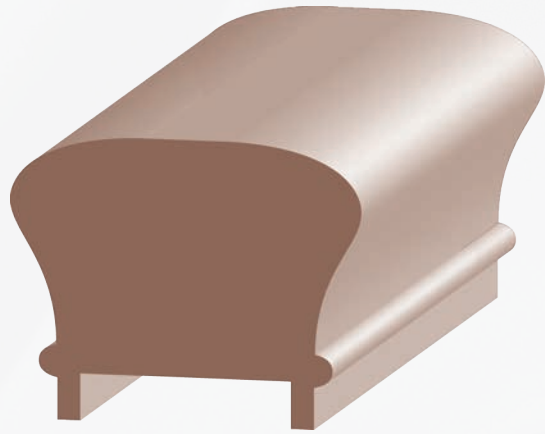

1-1/2 x 1-7/8 **Small #6010 Handrail**
w/ 1/4" x 1-1/8" Plow
932PPL Poplar **S**

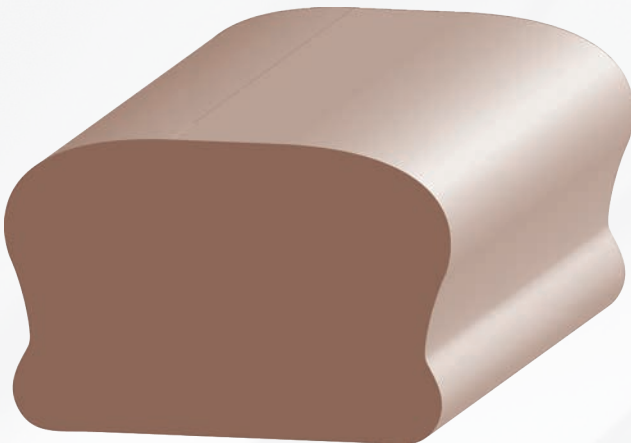

1-1/2 x 2-3/8 **Standard Handrail**
925-0 Oak **S**

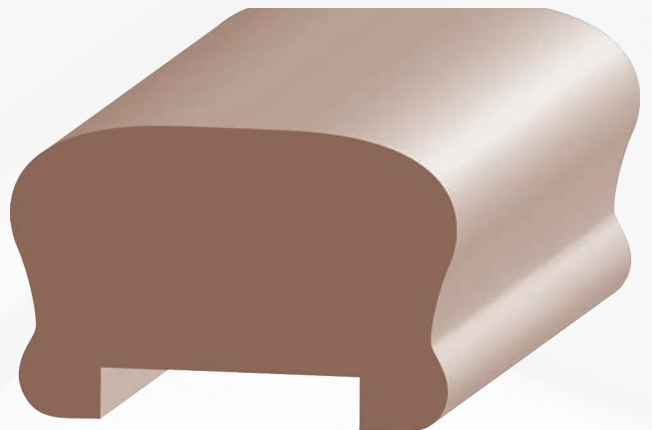

1-1/2 x 2-3/8 **Standard Handrail**
w/ 1/4" x 1-1/4" Plow
925-0PL Oak **S**



(items are approximate scale only)

Handrail

lengths available: 6' thru 16'

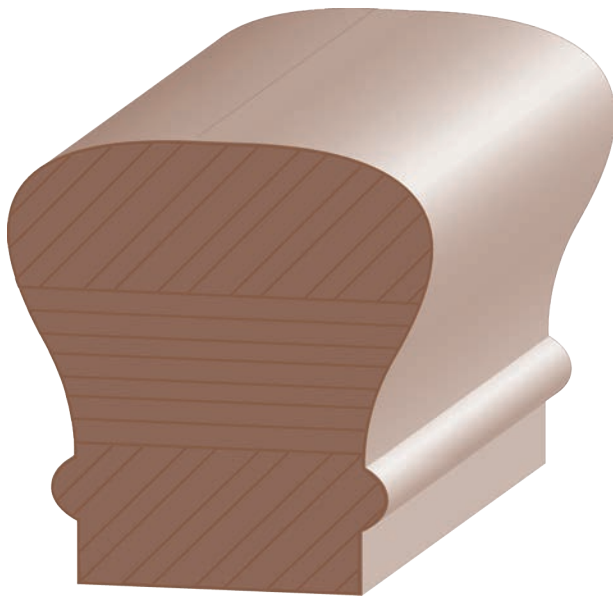

2-1/4 x 2-3/8 **Classic #6010 Handrail**
(3pc Glue Up)
931P Poplar **S**

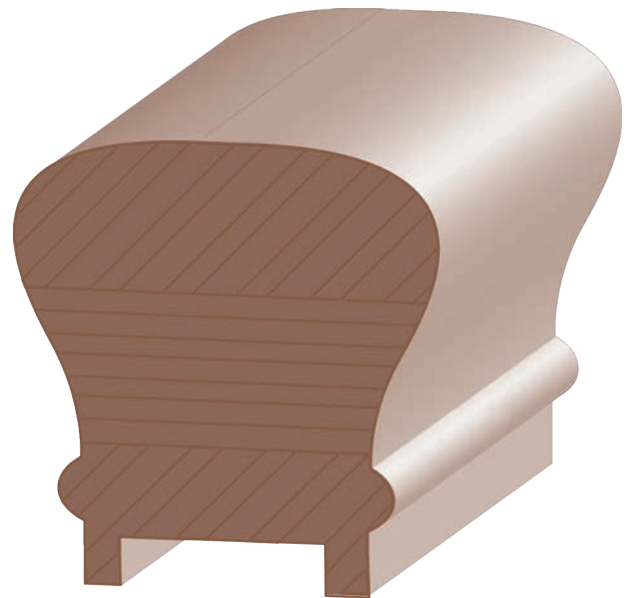

2-1/4 x 2-3/8 **Classic #6010 Handrail**
w/ 1/4" x 1-1/4" Plow (3pc Glue Up)
931PPL Poplar **S**

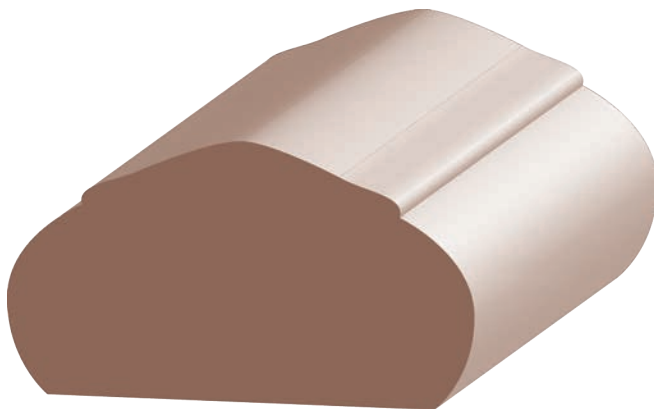

1-3/8 x 2-3/8 **"B" Mushroom Handrail**
928-0 Oak **S**

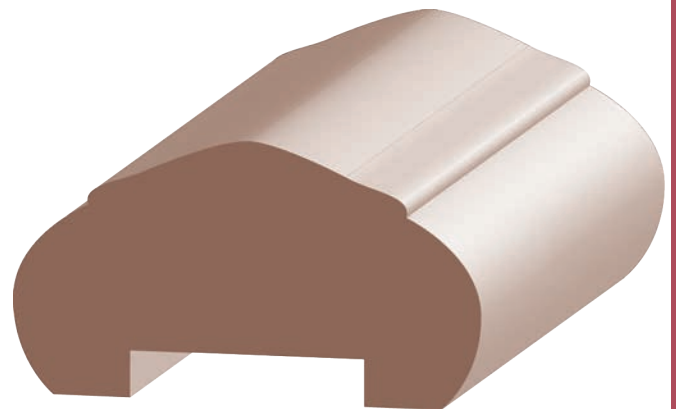

1-3/8 x 2-3/8 **"B" Mushroom Handrail**
w/ 1/4" x 1-1/4" Plow
928-0PL Oak **S**



Handrail

lengths available: 6' thru 16'

(items are approximate scale only)

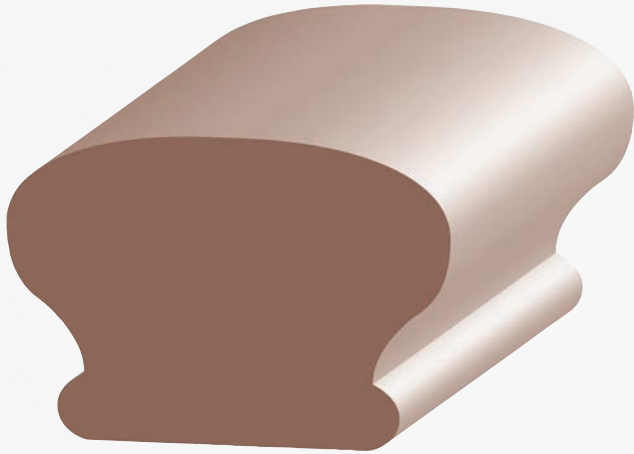

1-5/8 x 2-3/8 **Mushroom Handrail**
956-0 Oak **N**

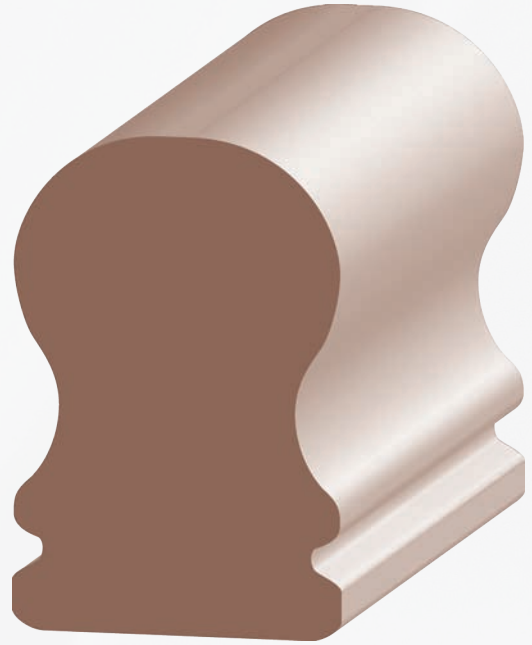

1-3/4 x 2-5/8 **Majestic Handrail**
933P Poplar **S**

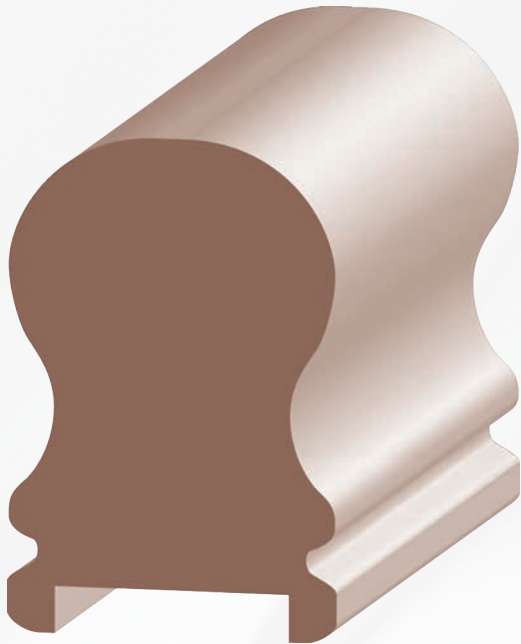

1-3/4 x 2-5/8 **Majestic Handrail**
w/ 1/4" x 1-1/4" Plow
933PPL Poplar **S**



Oak Threshold

lengths available: 3' thru 12'

(items are approximate scale only)



5/8 x 3-1/2 Threshold

850-0 Oak Lineal **S**

850-03 Oak 37" Piece **S**



3/4 x 3-1/2 Threshold

851-0 Oak Lineal **S**

851-03 Oak 37" Piece **S**

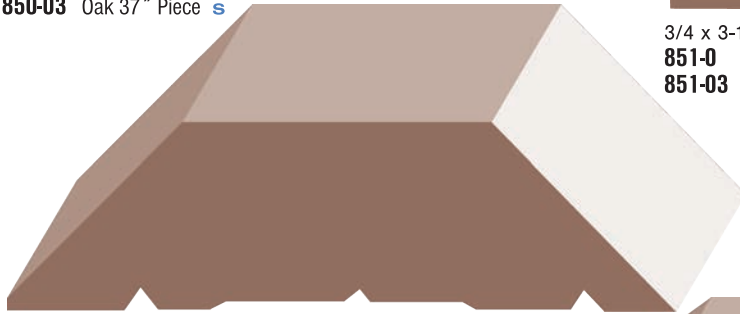

1 x 3-1/2 Threshold

854-0 Oak Lineal **S**

854-03 Oak 37" Piece **S**



3/4 x 4-1/2 Threshold

853-0 Oak Lineal **S**

853-03 Oak 37" Piece **S**



3/4 x 5-1/2 Threshold

852-0 Oak Lineal **S**

852-03 Oak 37" Piece **S**

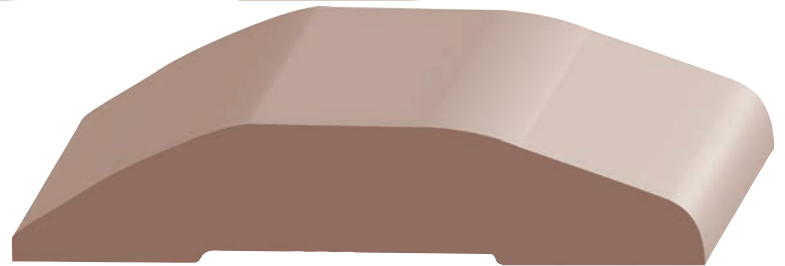

3/4 x 3-5/8 Threshold

860-0 Oak **N**

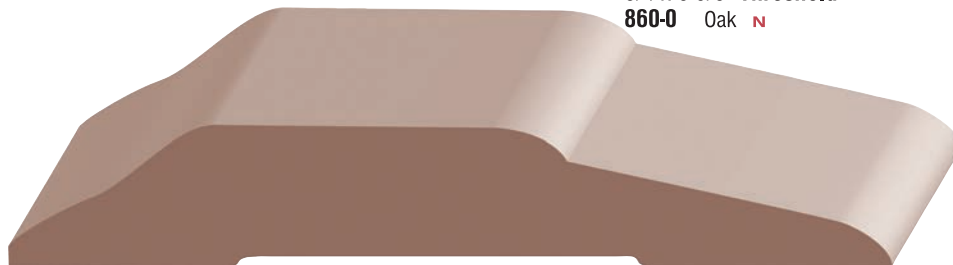

3/4 x 4-5/8 Threshold

858-0 Oak **N**

1-1/16 x 5-5/8 Threshold

859-0 Oak **N**



Sill

(items are approximate scale only)

lengths available: 3' thru 12'



1-1/16 x 5-1/4 **Door Sill** N

1-1/16 x 7-1/4 **Door Sill** N

| | | | | |
|----------------|-------------------|----------------------|-----------------------------|--------------------|
| 50S Oak | 5CS Cherry | 5MHS Mahogany | 5ALDS Superior Alder | 5WLS Walnut |
| 70S Oak | 7CS Cherry | 7MHS Mahogany | 7ALDS Superior Alder | 7WLS Walnut |



Beveled Sill

80S 1-1/4 x 7-1/8 Oak S

100S 1-1/4 x 8-7/8 Oak S

120S 1-1/4 x 11-1/4 Oak S



Flat Oak Sill

8FOS 1-1/4 x 7-1/4 Oak S

10FOS 1-1/4 x 8-7/8 Oak S

12FOS 1-1/4 x 11-1/4 Oak S



(items are approximate scale only)

Nose & Cove

lengths available: 6' through 16'

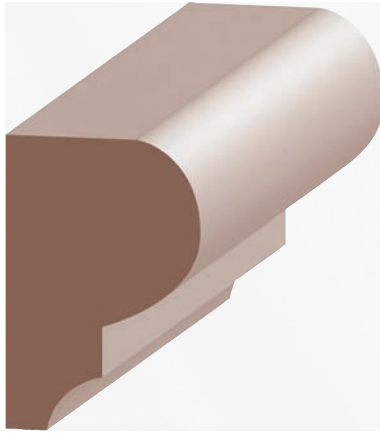

1 x 1-5/8 **Nose & Cove**
909P Poplar **N/S**
909-0 Oak **N/S**
909ALD Superior Alder **N/S**

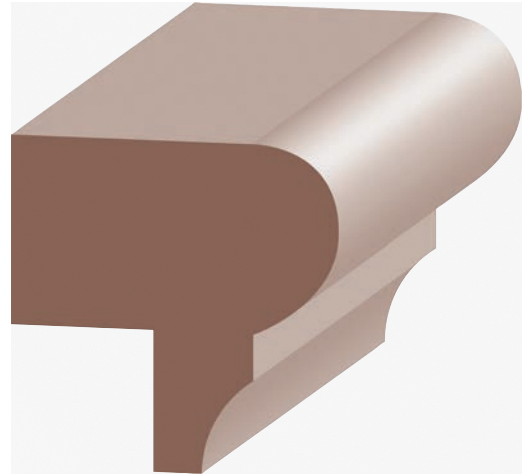

1-3/4 x 1-3/4 **Rab't Nose & Cove** [with 3/4" Rab't]
910P Poplar **N/S**
910-0 Oak **N/S**

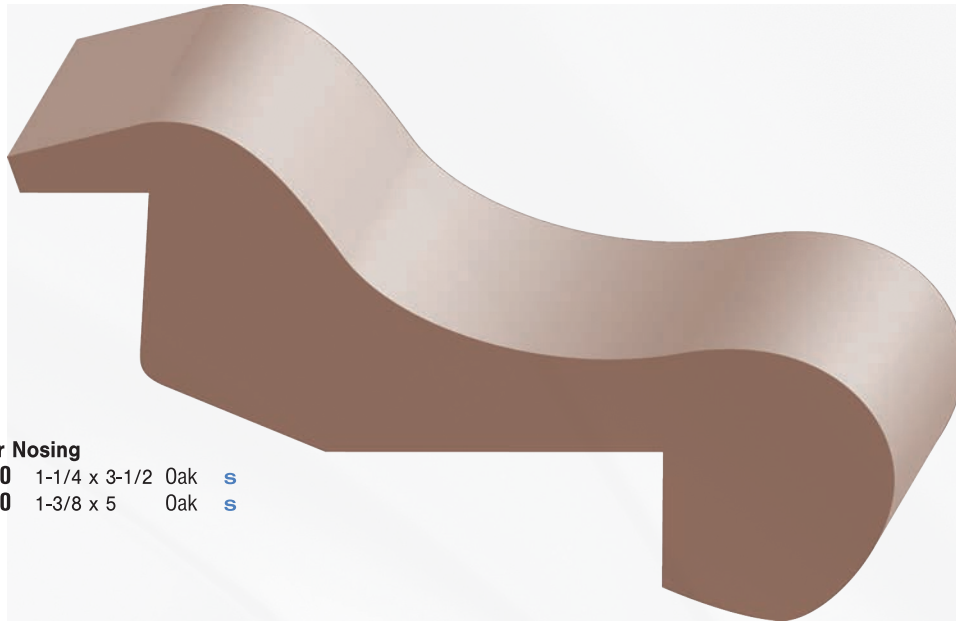

Bar Nosing
49-0 1-1/4 x 3-1/2 Oak **S**
50-0 1-3/8 x 5 Oak **S**



Stair Nosing

lengths available: 6' thru 16'

(items are approximate scale only)



1-1/16 x 3-1/2 **Nosing**
[with 1/4" x 2-1/8" Rab't]
912-0 Oak **N**

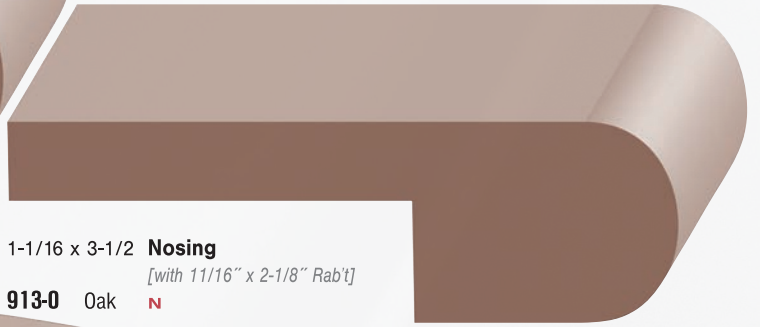

1-1/16 x 3-1/2 **Nosing**
[with 11/16" x 2-1/8" Rab't]
913-0 Oak **N**

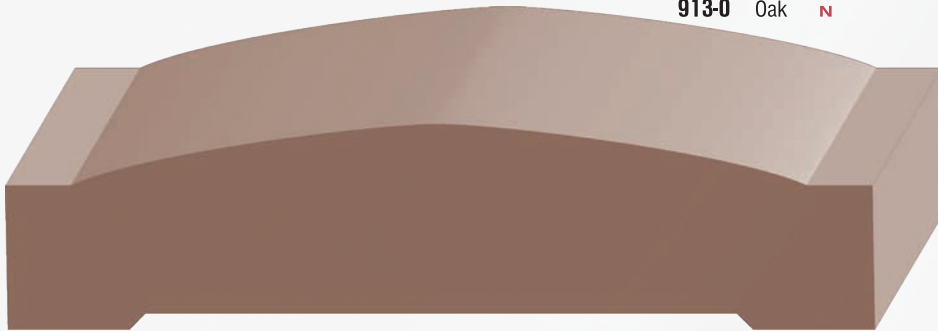

1-1/16 x 4-1/2 **Lintel Mold**
998P Poplar **S**



7/16 x 1-1/8 **Window Stool**
995P Poplar **N/S**



1/2 x 1-7/16 **Rab't Stool**
[with 1/8" x 1" Rab't]
997P Poplar **N/S**

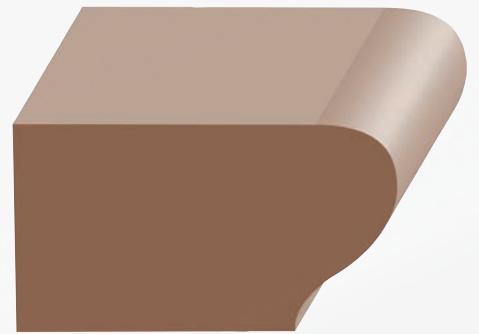

1-1/16 x 2 **Window Stool**
996P Poplar **N/S**

Stool

lengths available: 6' thru 16'



Ogee Stool
992P 11/16 x 5-7/16 Poplar **N** | **992-0** 11/16 x 5-1/4 Oak **N**
994P 11/16 x 7-1/4 Poplar **N** | **994-0** 11/16 x 7-1/4 Oak **N**

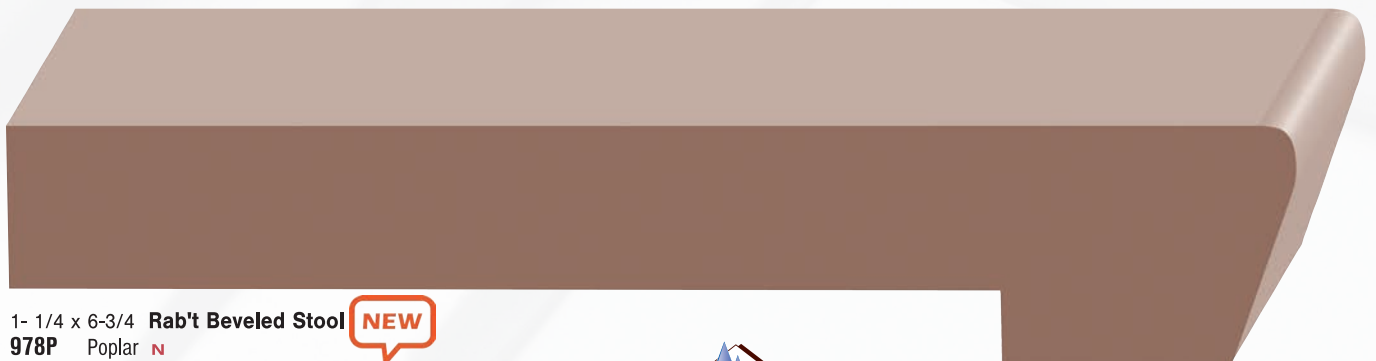

1- 1/4 x 6-3/4 **Rab't Beveled Stool** **NEW**
978P Poplar **N**



(items are approximate scale only)

Reducer

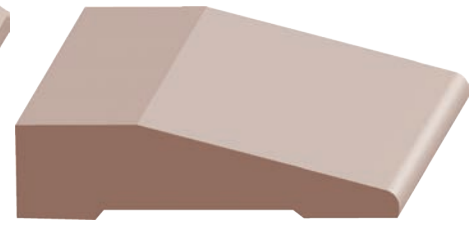
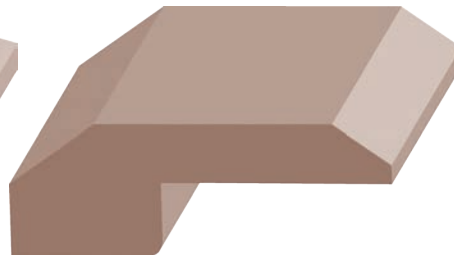
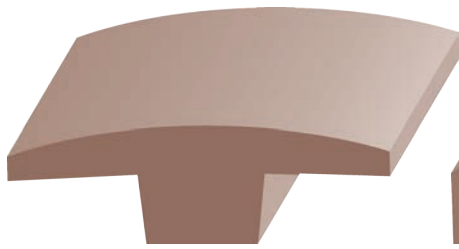

5/8 x 2 Reducer
892-0 Oak **S**
892C Cherry **S**
892MP Maple **S**

11/16 x 2 Variable Reducer
893-0 Oak **S**
893C Cherry **S**
893MP Maple **S**

1/2 x 2 Reducer
894-0 Oak **S**
894C Cherry **S**
894MP Maple **S**

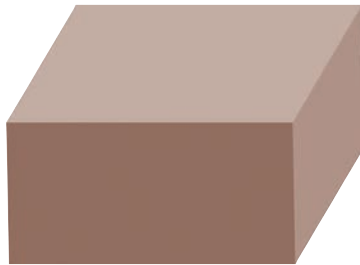

S4S Boards

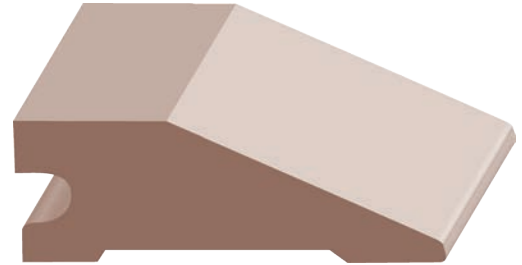

3/4 x 2-1/4 Reducer
899-0 Oak **S**
899C Cherry **S**
899MP Maple **S**

Poplar

| | | | |
|-------------|--------------|--------|------------|
| 713P | 3/4 x 1-5/8 | (1x2) | N/S |
| 714P | 3/4 x 2-1/2 | (1x3) | N/S |
| 715P | 3/4 x 3-1/2 | (1x4) | N/S |
| 750P | 3/4 x 5-1/2 | (1x6) | N/S |
| 751P | 3/4 x 7-1/4 | (1x8) | N/S |
| 752P | 3/4 x 9-1/4 | (1x10) | N/S |
| 753P | 3/4 x 11-1/4 | (1x12) | N/S |

Oak

| | | | |
|--------------|--------------|--------|------------|
| 713-0 | 3/4 x 1-5/8 | (1x2) | N/S |
| 714-0 | 3/4 x 2-1/2 | (1x3) | N/S |
| 715-0 | 3/4 x 3-1/2 | (1x4) | N/S |
| 750-0 | 3/4 x 5-1/2 | (1x6) | N/S |
| 751-0 | 3/4 x 7-1/4 | (1x8) | N/S |
| 752-0 | 3/4 x 9-1/4 | (1x10) | S |
| 753-0 | 3/4 x 11-1/4 | (1x12) | N/S |

Superior Alder

| | | | |
|---------------|-------------|--------|------------|
| 715ALD | 3/4 x 3-1/2 | (1x4) | N/S |
| 750ALD | 3/4 x 5-1/2 | (1x6) | N/S |
| 751ALD | 3/4 x 7-1/4 | (1x8) | N/S |
| 752ALD | 3/4 x 9-1/4 | (1x10) | S |

Cherry

| | | | |
|-------------|--------------|--------|------------|
| 714C | 3/4 x 2-1/2 | (1x3) | N |
| 715C | 3/4 x 3-1/2 | (1x4) | N/S |
| 750C | 3/4 x 5-1/2 | (1x6) | N/S |
| 751C | 3/4 x 7-1/4 | (1x8) | N/S |
| 752C | 3/4 x 9-1/4 | (1x10) | N/S |
| 753C | 3/4 x 11-1/4 | (1x12) | N |

Maple

| | | | |
|--------------|--------------|--------|------------|
| 714MP | 3/4 x 2-1/2 | (1x3) | N |
| 715MP | 3/4 x 3-1/2 | (1x4) | N/S |
| 750MP | 3/4 x 5-1/2 | (1x6) | N/S |
| 751MP | 3/4 x 7-1/4 | (1x8) | N/S |
| 752MP | 3/4 x 9-1/4 | (1x10) | S |
| 753MP | 3/4 x 11-1/4 | (1x12) | N |

Mahogany

| | | | |
|--------------|--------------|--------|------------|
| 713MH | 3/4 x 1-5/8 | (1x2) | N |
| 714MH | 3/4 x 2-1/2 | (1x3) | N |
| 715MH | 3/4 x 3-1/2 | (1x4) | N/S |
| 750MH | 3/4 x 5-1/2 | (1x6) | N/S |
| 751MH | 3/4 x 7-1/4 | (1x8) | N/S |
| 752MH | 3/4 x 9-1/4 | (1x10) | S |
| 753MH | 3/4 x 11-1/4 | (1x12) | N/S |

Knotty Alder 2E2

| | | | |
|--------------|---------------|--------|----------|
| 715KA | 3/4 x 3-1/2 | (1x4) | N |
| 750KA | 3/4 x 5-1/2 | (1x6) | N |
| 754KA | 1 x 5-1/2 | (1x6) | N |
| 756KA | 1-1/2 x 5-1/2 | (2x6) | N |
| 751KA | 3/4 x 7-1/4 | (1x8) | N |
| 753KA | 3/4 x 11-1/4 | (1x12) | N |

Ropes

lengths available: 8'



Poplar Half Round

| | | |
|---------------|---------|------------|
| HR617P | 3/8" | S |
| HR618P | 1/2" | N/S |
| HR619P | 11/16" | N/S |
| HR620P | 1" | N/S |
| HR621P | 1-3/16" | S |
| HR622P | 1-3/8" | S |
| HR623P | 1-1/2" | S |
| HR624P | 1-3/4" | S |

Oak Half Round

| | | |
|----------------|---------|------------|
| HR617-0 | 3/8" | S |
| HR618-0 | 1/2" | N/S |
| HR619-0 | 3/4" | N/S |
| HR620-0 | 1" | N/S |
| HR621-0 | 1-3/16" | S |
| HR622-0 | 1-3/8" | S |
| HR623-0 | 1-1/2" | S |
| HR624-0 | 1-3/4" | S |

Sup. Alder Half Round

| | | |
|-----------------|---------|------------|
| HR618ALD | 1/2" | N/S |
| HR619ALD | 3/4" | N/S |
| HR620ALD | 1" | N/S |
| HR621ALD | 1-3/16" | S |
| HR622ALD | 1-3/8" | S |
| HR623ALD | 1-1/2" | S |
| HR624ALD | 1-3/4" | S |

Cherry Half Round

| | | |
|---------------|---------|------------|
| HR617C | 3/8" | S |
| HR618C | 1/2" | N/S |
| HR619C | 11/16" | N/S |
| HR620C | 1" | N/S |
| HR621C | 1-3/16" | S |
| HR622C | 1-3/8" | S |
| HR623C | 1-1/2" | S |
| HR624C | 1-3/4" | S |

Maple Half Round

| | | |
|----------------|---------|------------|
| HR618MP | 1/2" | N/S |
| HR619MP | 11/16" | N/S |
| HR620MP | 1" | N/S |
| HR621MP | 1-3/16" | S |
| HR622MP | 1-3/8" | S |
| HR623MP | 1-1/2" | S |
| HR624MP | 1-3/4" | S |

Poplar Full Round

| | | |
|---------------|--------|----------|
| FR626P | 1-3/8" | S |
| FR627P | 1-3/4" | S |

Oak Full Round

| | | |
|----------------|--------|----------|
| FR626-0 | 1-3/8" | S |
| FR627-0 | 1-3/4" | S |

Cherry Full Round

| | | |
|---------------|--------|----------|
| FR626C | 1-3/8" | S |
| FR627C | 1-3/4" | S |



3/4" Exterior Door Frames

(items are approximate scale only)

lengths available: 6' thru 16'

Door Frame Specs

- ☑ 1-1/4" Thick **N**
- ☑ 6/8 = 82-1/2" Below Dado
- ☑ 8/0 = 98-1/2" Below Dado
- ☑ No Screen Rabbet
- ☑ Single End Dado (Except on Lineal)
- ☑ 3 Pair Per Bundle
- ☑ Kerfing for Bullnose is Available
- ☑ Custom Widths Available

FOR 1-3/4" DOORS



Standard = No "W" in Part #



Weatherstrip Kerfed = "W" in Part # **Qlon Sold Separately**

EXTERIOR DOOR FRAMES

Standard 1-13/16" Door Rab't.

Weatherstrip Kerfed with 1/2" x 2-1/8" Door Rab't.

| SIZE | Oak | | | Superior Alder | | Knotty Alder | | Poplar | | | Mahogany | | | Cherry | | | |
|-------|----------------|----------------|----------------|----------------|---------|--------------|---------|-----------------|-----------------|-----------------|-----------------|-----------------|-----------------|--------|--------|--------------|-----|
| | 6/8 | 8/0 | RNDM. LINEAL | 6/8 | 8/0 | 6/8 | 8/0 | 6/8 | 8/0 | RNDM. LINEAL | 6/8 | 8/0 | RNDM. LINEAL | 6/8 | 8/0 | RNDM. LINEAL | |
| 4-1/8 | 41806 | 41808 | 4180L | N/A | N/A | N/A | N/A | 418P6 | 418P8 | 418PL | 418M6 | 418M8 | 418ML | 418C6 | 418C8 | 418CL | N/S |
| | 418W06 | 418W08 | 418W0L | N/A | N/A | N/A | N/A | 418WP6 | 418WP8 | 418WPL | 418WM6 | 418WM8 | 418WML | 418WC6 | 418WC8 | 418WCL | N/S |
| 4-1/2 | 41206 | 41208 | 4120L | N/A | N/A | N/A | N/A | N/A | N/A | N/A | N/A | N/A | N/A | N/A | N/A | N/A | S |
| | N/A | N/A | 412W0L | N/A | N/A | N/A | N/A | N/A | N/A | N/A | N/A | N/A | N/A | N/A | N/A | N/A | S |
| 4-5/8 | 45806 N | 45808 N | 4580L N | 458SA6 | 458SA8 | 458KA6 | 458KA8 | 458P6 N | 458P8 N | 458PL N | 458M6 N | 458M8 N | 458ML N | 458C6 | 458C8 | 458CL | N/S |
| | 458W06 | 458W08 | 458W0L | 458WSA6 | 458WSA8 | 458WKA6 | 458WKA8 | 458WP6 N | 458WP8 N | 458WPL N | 458WM6 N | 458WM8 N | 458WML N | 458WC6 | 458WC8 | 458WCL | N/S |
| 5-1/4 | 5140E6 | 5140E8 | 5140EL | 514SAE6 | 514SAE8 | 514KAE6 | 514KAE8 | 514PE6 | 514PE8 | 514PEL | 514ME6 | 514ME8 | 514MEL | 514CE6 | 514CE8 | 514CEL | N/S |
| | 514W06 | 514W08 | 514W0L | 514WSA6 | 514WSA8 | 514WKA6 | 514WKA8 | 514WP6 | 514WP8 | 514WPL | 514WM6 | 514WM8 | 514WML | 514WC6 | 514WC8 | 514WCL | N/S |
| 6-5/8 | N/A | N/A | N/A | N/A | N/A | N/A | N/A | N/A | N/A | N/A | N/A | N/A | N/A | 658C6 | 658C8 | N/A | N/S |
| | N/A | N/A | N/A | N/A | N/A | N/A | N/A | N/A | N/A | N/A | N/A | N/A | N/A | 658WC6 | 658WC8 | N/A | N/S |
| 7-1/4 | 7140E6 | 7140E8 | 7140EL | 714SAE6 | 714SAE8 | 714KAE6 | 714KAE8 | 714PE6 | 714PE8 | 714PEL | 714ME6 | 714ME8 | 714MEL | 714CE6 | 714CE8 | 714CEL | N/S |
| | 714W06 | 714W08 | 714W0L | 714WSA6 | 714WSA8 | 714WKA6 | 714WKA8 | 714WP6 | 714WP8 | 714WPL | 714WM6 | 714WM8 | 714WML | 714WC6 | 714WC8 | 714WCL | N/S |
| 9-1/4 | N/A | N/A | N/A | N/A | N/A | 914WKA6 | 914WKA8 | N/A | N/A | N/A | N/A | N/A | N/A | N/A | N/A | N/A | N/S |

Interior Door Jamb Specs

(NOR CAL, CENTRAL CAL, AZ) / (SO CAL, NV)

- ☑ 1 1/16" Thick
- ☑ 6/8 = 81" Below Dado **N/CC/AZ**
- ☑ 8/0 = 97" Below Dado **N/CC/AZ**
- ☑ 6/8 = 80-5/8" Below Dado **S/NV**
- ☑ 8/0 = 96-5/8" Below Dado **S/NV**
- ☑ Lineal - Available in random lengths. Check for specific length availability
- ☑ Random Lengths only available in most Solid Wood Species
- ☑ Dado depth is 3/8"
- ☑ Heads cut 3/4 over opening
- ☑ 5 pair per bundle

Kerfing for bullnose is available on all jamb sizes and species.
Custom size odd wall widths available upon request.

Interior Jamb

lengths available: 6' & 16'



INTERIOR DOOR JAMBS

| SIZE | Red Oak | | | Superior Alder | | | Knotty Alder | | | Poplar | | | Mahogany | Cherry | | | |
|---------|---------|---------|--------------|----------------|-----------|--------------|--------------|----------|--------------|---------|---------|--------------|------------------|------------------|------------------|--------------|-----|
| | 6/8 | 8/0 | RNDM. LINEAL | 6/8 | 8/0 | RNDM. LINEAL | 6/8 | 8/0 | RNDM. LINEAL | 6/8 | 8/0 | RNDM. LINEAL | 8/0 | 6/8 | 8/0 | RNDM. LINEAL | |
| 3-9/16 | N/A | N/A | N/A | 3916ALDI6 | 3916ALDI8 | 3916ALDIL | 3916KAI6 | 3916KAI8 | 3916KAIL | N/A | N/A | N/A | N/A | 3916CI6 N | 3916CI8 N | N/A | N/S |
| 4-9/16 | 49160I6 | 49160I8 | 49160IL | 4916ALDI6 | 4916ALDI8 | 4916ALDIL | 4916KAI6 | 4916KAI8 | 4916KAIL | 4916PI6 | 4916PI8 | 4916PIL | N/A | 4916CI6 | 4916CI8 | 4916CIL | N/S |
| 4-5/8 | N/A | N/A | N/A | 458ALDI6 | 458ALDI8 | 458ALDIL | N/A | N/A | N/A | N/A | N/A | N/A | N/A | N/A | N/A | N/A | S |
| 4-7/8 | N/A | N/A | N/A | 478ALDI6 | 478ALDI8 | 478ALDIL | N/A | N/A | N/A | N/A | N/A | N/A | N/A | N/A | N/A | N/A | S |
| 4-13/16 | 4340I6 | 4340I8 | 4340IL | 434ALDI6 | 434ALDI8 | 434ALDIL | 434KAI6 | 434KAI8 | 434KAIL | 434PI6 | 434PI8 | 434PIL | 434MHI8 S | 434CI6 | 434CI8 | 434CIL | N/S |
| 5-1/4 | 5140I6 | 5140I8 | 5140IL | 514ALDI6 | 514ALDI8 | 514ALDIL | 514KAI6 | 514KAI8 | 514KAIL | 514PI6 | 514PI8 | 514PIL | 514MHI8 S | 514CI6 | 514CI8 | 514CIL | N/S |
| 7-1/4 | 7140I6 | 7140I8 | 7140IL | 714ALDI6 | 714ALDI8 | 714ALDIL | 714KAI6 | 714KAI8 | 714KAIL | 714PI6 | 714PI8 | 714PIL | 714MHI8 S | 714CI6 | 714CI8 | 714CIL | N/S |
| 9-1/4 | N/A | N/A | N/A | N/A | N/A | N/A | 914KAI6 | 914KAI8 | 914KAIL | N/A | N/A | N/A | N/A | N/A | N/A | N/A | N/S |
| 11-1/4 | 11140I6 | 11140I6 | 11140I6 | N/A | N/A | N/A | N/A | N/A | N/A | 1114PI6 | 1114PI8 | 1114PIL | N/A | N/A | N/A | N/A | S |





©2018. All White River products are copyrighted and proprietary and cannot be duplicated without express permission.

White River Embossed and **Mon Reale** high clay relief mouldings add elegance with ornamental detail, historically found throughout the world. Millwork, cabinetry, mirrors, mantels and more are instantly transformed into a style reflecting master craftsmanship. Embossed mouldings are created by pressing a pattern into the wood and altering the wood fibers. High Relief (Mon Reale) millwork is created using a clay overlay on poplar wood with a wheel that presses a design into the clay. The result is beautiful, sharp details that resemble the details of plaster ornamentation, only in wood that's easy to install.

Most White River™ products are stocked in our Southern California facility and are transferred to Northern California. Please allow 2-3 days for delivery in NorCal and next-day delivery in SoCal. For White River's full line of products, please refer to whiteriver.com. Special orders and Flex may take 2-3 weeks for delivery.



section contents

EMBOSSSED

| | |
|----------------------|-----|
| Backbands..... | 333 |
| Base | 333 |
| Casing..... | 333 |
| Chair Rail..... | 333 |
| Cornice (Crown)..... | 334 |
| Panel Mold | 335 |
| Lineal Moulding..... | 336 |

MON REALE

| | |
|--------------------------------|-----|
| Backbands..... | 338 |
| Casing..... | 338 |
| Cornice Mouldings | 339 |
| Frieze Mouldings..... | 340 |
| Panel Mold | 341 |
| Staining and Installation..... | 344 |

White River™

UNSURPASSED DEFINITION, STAINABILITY AND AFFORDABILITY



©2018. All White River products are copyrighted and proprietary and cannot be duplicated without express permission.

White River™ Embossed and Mon Reale High Relief mouldings give profiles a beautifully subtle ornamental look beyond standard mouldings.

Express a different look or feel in any room or your entire home with White River™ products from EL & EL. Mouldings have long been recognized for the beauty and elegance they can create. Embossed and Mon Reale mouldings create a customized and unique look for any home, enhancing bookshelves, cabinetry and mirrors, far beyond common moulding applications.

Products can be used alone or combined together to create larger scale details and install with standard woodworking tools. Profiles ship unfinished and can be stained or painted.

Whether you are working on a residential remodel, new construction or restoration project there's a design solution that will finish it off with style.



random lengths standard 3'-16'

large selection of styles in stock

custom milling available



(items are approximate scale only)

Embossed Poplar Casing, Backbands & Base

lengths available: mixed length bundles 3' thru 16'

Ornamentally Embossed™ is a proprietary trademark of White River™ Hardwoods-Woodworks, Inc.® including: crowns, cases, baseboards, chairrails and panel moulds.

BASE I



BA42 3/4" x 7" **Rope Base**



BA43C 3/4" x 5-1/2"
Egg & Dart w/Bead & Barrel Base



BA44 3/4" x 6" **Rope Base**



BA46 11/16" x 5-1/2" **Bead & Barrel Base**



BA47 3/4" x 5-1/2" **Leaf & Reed Base**



BA48 11/16" x 5-1/2" **Running Coin Base**

BACKBANDS I Backbands lip casings to add depth, width, & detail.



BB15 1-1/2" x 1-3/8" lips 13/16"
Roman Coin Back Band



BB17 1-3/4" x 2-1/2" lips 13/16"
Egg & Dart w/Bead & Barrel Back Band

CHAIR RAILS I



CR61 13/16" x 2-1/2"
Fluting Chair Rail



CR63A 1-1/16" x 3-1/4"
Running Coin w/Bead & Barrel Chair Rail



CR64 1-1/16" x 3"
Laurel Leaf w/Bead & Barrel Chair Rail



CR65 13/16" x 2-1/2"
Egg & Dart Chair Rail



CR66 1" x 3-1/2" *pattern repeats 7-1/2"*
Reed & Ribbon Chair Rail



CR67 13/16" x 2-1/8"
Dentil Chair Rail



CR68 1-3/4" x 2-1/2" lips 13/16"
Rab't Rope Chair Rail



CR69 1-1/16" x 2 1/4"
Dentil w/Rope Chair Rail



CR70 3/4" x 3"
Fluting Chair Rail



CR72 3/4" x 3"
Running Leaf Chair Rail

CASING I



CA30 13/16" x 3-3/4"
Rope Casing



CA31 13/16" x 4"
Acanthus Leaf w/Bead & Barrel Casing



CA36 13/16" x 3-1/4"
Bead & Barrel Casing



CA37 1-1/16" x 4"
Lamb's Tongue w/Rope Casing



CA38 1-1/4" x 4"
Egg & Dart w/Rope Casing



CA39 13/16" x 3-1/2"
Egg & Dart w/Bead & Barrel Casing



CA40 1-1/4" x 4"
CA41 13/16" x 3-1/4"
Leaf & Reed w/Bead Casing



DH99 1-1/16" x 5-1/4"
Bead & Barrel Decorative Header

Poplar Embossed Cornice Mouldings

lengths available: mixed length bundles 3' thru 16'

(items are approximate scale only)



CM69 3/4" x 2-3/4"
Egg & Dart with Rope Cornice



CM81 1-1/16" x 4-3/4"
Lamb's Tongue Cornice



CM88 3/4" x 2-3/4"
Rope Cornice



CM70 13/16" x 4-3/8"
Fluted Cornice



CM82 1-1/16" x 5-7/8"
Coin with Rope & Tongue Cornice



CM89 3/4" x 2-3/4"
Egg & Dart Cornice



CM71 13/16" x 4-1/2"
Egg & Dart with Lamb's
Tongue Cornice



CM83 13/16" x 5-1/2"
Egg & Dart with Lamb's
Tongue Cornice



CM90 3/4" x 5-1/2"
Leaf & Reed with Bead Crown



CM72 13/16" x 3-3/4"
Egg & Dart Cornice



CM84 13/16" x 6-1/4"
Bead with Lamb's Tongue Cornice



CM93 13/16" x 5-1/2"
Fluting & Coins Cornice



CM75 13/16" x 5-3/16"
Bead with Dentil Cornice



CM85 13/16" x 3-3/4"
Bead Cornice



CM94 13/16" x 5-1/2"
Running Leaf & Coins Crown



CM76 13/16" x 5-1/2"
Acanthus Leaf with
Bead & Barrel Cornice



CM86 13/16" x 7"
Dentil with Lamb's Tongue Cornice



CM95 13/16" x 3"
Fluting Crown



CM77 13/16" x 4"
Acanthus Leaf with
Bead & Barrel Cornice



CM87 3/4" x 5"
Dentil with Rope Cornice



CM96 13/16" x 3"
Running Leaf Crown



CM80 13/16" x 5-1/2"
Fluting with Beads Cornice

(items are approximate scale only)

Poplar Embossed® Panel Mouldings

NOTE: Panel mouldings have a flat back unless otherwise noted.



PM07 5/8" x 1-1/8"
Laurel Leaf Panel Mold



PM08 5/8" x 1-1/4"
Vining Berries Panel Mold



PM09 5/8" x 1-1/4"
Acanthus Scrolls Panel Mold



PM10 5/8" x 1-1/4"
Egg & Dart Panel Mold



PM11 7/16" x 5/8"
Rope Panel Mold



PM12 5/8" x 1-1/8"
Running Coin Panel Mold



PM14 1/2" x 1"
Bead & Barrel Panel Mold



PM20 13/16" x 2"
Bead & Barrel w/Lamb's Tongue Panel Mold



PM22PL 11/16" x 1-3/4" lips 1/4"
Rab't Bead & Barrel Panel Mold



PM22 11/16" x 1-3/4"
Bead & Barrel Panel Mold



PM23B 3/4" x 2"
Running Coin w/Rope Panel Mold



PM24 3/4" x 2"
Bead w/Bead & Barrel Panel Mold



PM25 1" x 2-1/2"
Laurel Leaf w/Bead & Barrel Panel Mold



PM27 3/4" x 2"
Rope Panel Mold



PM50 3/4" x 1-1/4"
Lamb's Tongue Panel Mold



PM52 13/16" x 1-3/4"
Running Coin Panel Mold



PM54 11/16" x 1-1/2"
Rope Panel Mold



PM55 13/16" x 1-1/4"
Laurel Leaf Panel Mold



PM56B 1/2" x 7/8"
Reed & Ribbon Panel Mold



PM57 5/8" x 1-1/4"
Rope Panel Mold



PM58 5/8" x 1"
Bead & Barrel Panel Mold



PM595 5/8" x 3-1/4"
Traditional Panel Mold



PM59 5/8" x 3/4"
Bead & Barrel Panel Mold



PM70 3/4" x 2-3/8" lips 1/2" - 3/4"
Rope Panel Mold



PM71 3/4" x 1-3/4"
Leaf & Reed Panel Mold



PM72 11/16" x 1-5/8"
Egg & Dart w/Bead & Barrel Panel Mold



PM73 5/8" x 1"
Egg & Dart Panel Mold



PM74 3/8" x 1/2"
Bead & Barrel Panel Mold



PM16 3/4" x 3" MDF Running Leaf & Bead

Poplar Embossed® Lineal Mouldings

LINEAL MOULDINGS I



LM90 1-1/16" x 3-1/2" *pattern repeats 6 3/8"*
Grapevine Lineal



LM91 1-1/16" x 3-1/2"
Flute w/Leaf Lineal



LM92 1-1/16" x 3-1/2"
Greek Key Lineal



©2018. All White River products are copyrighted and proprietary and cannot be duplicated without express permission.

Mon Reale is a fine-grained overlay material contoured to traditional hardwood to create a moulding of unusual elegance. The depth of detail creates a greater degree of definition than found in our ornamentally embossed mouldings. Discriminating architects, interior designers and decorators look forward to crafting new levels of aesthetics in their most important projects for their most refined clients.

section contents

| | |
|--|-----|
| Poplar Mon Reale® Backbands | 338 |
| Poplar Mon Reale® Casing | 338 |
| Poplar Mon Reale® Cornice Mouldings.. | 339 |
| Poplar Mon Reale® Frieze Mouldings.... | 340 |
| Poplar Mon Reale® Panel Molds | 341 |
| Staining & Installation | 344 |



Poplar Mon Reale® Backbands, Casing

(items are approximate scale only)



BB8108 1-3/4" x 2" lips 13/16"
Lamb's Tongue



CA8320 1-1/4" x 4-1/2"
Running Leaf & Bead Casing



CA8336 1-7/8" x 5" Repeats 8"
Bead & Barrel w/Reed & Ribbon Casing



BB8109 2" x 2-1/2" lips 13/16"
Ropes of Antiquity Backband



CA8322 1-1/16" x 4-1/2"
Large Rope Casing



CA8338 13/16" x 3-3/4"
Small Bead Casing



BB8110 1-13/16" x 1-1/2" lips 13/16"
Coin Backband
Repeats 1"



CA8326 1-1/4" x 4-1/2" Repeats 4-3/4"
Reed & Ribbon Casing



CA8340 1-1/16" x 3-3/4"
Running Leaf & Bead Casing



BB8111 1-3/4" x 2-1/2" lips 13/16"
Petite Acanthus Leaf Backband
Repeats 2-7/8"



CA8330 1-7/8" x 5" Repeats 8"
Large Bead w/Laurel Leaf & Ribbon Casing



CA8342 13/16" x 3-3/4"
Rope Casing



BB8122 1-13/16" x 2" lips 13/16"
Running Leaf & Pearl Backband
Repeats 2-1/4"



Backbands Lip 13/16" Casings
Drawing shows BB8120 with CA364



CA8344
13/16" x 4"



CA8344 13/16" x 4"
Lamb's Tongue & Bead Casing



BA8440 3/4" x 6-1/2"
Running Leaf Base Repeats 2-1/4"

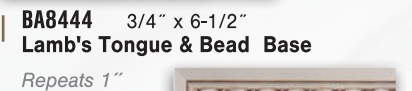

BA8444 3/4" x 6-1/2"
Lamb's Tongue & Bead Base
Repeats 1"



CA8347 1-3/8" x 4"
Egg & Dart w/Lamb's Tongue Casing



BA8442 3/4" x 6"
Rope Base Repeats 1-1/4"



CA8348 1-3/8" x 4"
Running Leaf w/Lamb's Tongue Casing

(items are approximate scale only)

Poplar Mon Reale® Cornice Mouldings

lengths available: mixed length bundles 3' thru 16'



CM8780 1-1/16" x 8-1/2"
Acanthus Leaf & Coin Crown



CM8782 13/16" x 5-1/2"
Acanthus Leaf Crown



CM8783 3/4" x 2-3/4"
Small Acanthus Leaf Crown



CM8801 7/8" x 6"
Large Acanthus Leaf Crown
Pattern Repeats 7"



CM8808 7/8" x 7-1/2"
Acanthus w/Egg & Dart & Dentil Crown
Pattern Repeats 7-1/2"



CM8810 15/16" x 4-3/4"
Medium Acanthus Leaf Crown
Pattern Repeats 4-3/4"



CM8812 1" x 6"
Medium Acanthus Leaf w/Egg & Dart Crown



CM8820 13/16" x 2-3/4"
Petite Acanthus Leaf Crown
Pattern Repeats 2-7/8"



CM8823 1" x 3-3/4"
Egg & Dart Crown
Pattern Repeats 3"



CM8825 1" x 7-1/2"
Egg & Dart w/Running Leaf Crown



CM8830 7/8" x 6"
Flute & Leaf w/Beads Crown
Pattern Repeats 13-1/2"



CM8834 3/4" x 4"
Large Rope Crown



CM8837 7/8" x 7"
Petite Acanthus Leaf Egg & Dart Crown



CM8840 7/8" x 7-1/2"
Egg & Dart with Dentil Crown



CM8853 1-1/16" x 8-1/2"
X-Large Acanthus Leaf Crown



CM8854 1-1/16" x 7-1/2"
Acanthus Leaf with Beads Crown



CM8856 13/16" x 6-1/2"
Lamb's Tongue with Bead Crown

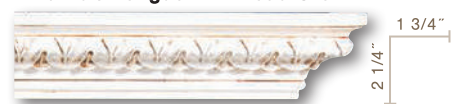

CM8857 3/4" x 2-3/4"
Lamb's Tongue Crown
Pattern Repeats 1-3/8"



CM8858 13/16" x 7"
Egg & Dart with Bead & Dentil Crown



CM8859 13/16" x 4"
Egg & Dart with Lamb's Tongue Crown



CM8860 3/4" x 3"
Lamb's Tongue Crown



CM8862 13/16" x 5"
Egg & Dart Crown



Poplar Mon Reale® Frieze Mouldings

(items are approximate scale only)

Mon Reale® is a registered trademark of White River™ Hardwoods-Woodworks, Inc.® and includes: crowns, cases, bases, friezes and panel moulds.



FR8920 13/16" x 3-3/4"
Fluting Frieze
Repeats 7/8" - MT = 3/4"



FR8950 13/16" x 5-1/2"
Country Flowers Frieze
Repeats 26" - MT = 1-1/16"



FR8957 13/16" x 5-1/2"
Ribbon & Bow Swag Frieze
Repeats 8" - MT = 15/16"



FR8921 13/16" x 3-3/4"
Leafy Scroll Frieze
Repeats 6-1/8" - MT = 1"



FR8953 13/16" x 5-1/2"
Eternal Laurel Leaves
Repeats 7-1/2" - MT = 1-1/8"



FR8958 13/16" x 5-1/2"
Palmetto & Lotus Frieze
Repeats 5" - MT = 13/16"



FR8922 13/16" x 3-3/4"
Running Coin Frieze
Repeats 2" - MT = 1"



FR8954 13/16" x 5-1/2"
Vitruvian Wave Frieze
Repeats 3-1/2" - MT = 7/8"



FR8960 13/16" x 5-1/2"
Shell & Fret Frieze
Repeats 16" - MT = 1"



FR8923 13/16" x 3-3/4"
Greek Keys w/Rosettes Frieze
Repeats 19" - MT = 7/8"



FR8955 13/16" x 5-1/2"
Griffins & Urns Frieze
Repeats 26-1/2" - MT = 7/8"



FR8965 13/16" x 5-1/2"
Rinceau Scrolls Frieze
Repeats 11-1/2" - MT = 7/8"



FR8940 13/16" x 3-3/4"
Roses & Butterflies Frieze
Repeats 12-1/2" - MT = 7/8"



FR8956 13/16" x 5-1/2"
Grapevine & Tassel Frieze
Repeats 24" - MT = 1"



FR8967 13/16" x 6-3/4"
Large Scrolled Palmette Frieze

(items are approximate scale only)

Poplar Mon Reale® Panel Mold



PM8511 13/16 x 2 **Running Leaf** [Pattern Repeats 2-1/4"]



PM8520 7/8 x 2 **Running Coin** [Pattern Repeats 1"]



PM8522 9/16 x 1 **Small Beads** [Pattern Repeats 1/4"]



PM8523 7/8 x 1-3/4 **Large Beads** [Pattern Repeats 1/2"]



PM8524 5/8 x 1 **Small Beads** [Pattern Repeats 1/4"]



PM8525 7/8 x 1-1/2 **Large Beads** [Pattern Repeats 1/2"]



PM8526 9/16 x 1 **Small Bead & Barrel** [Pattern Repeats 2-3/8"]



PM8527 7/8 x 1-3/4 **Large Bead & Barrel** [Pattern Repeats 5"]



PM8528 5/8 x 1 **Bead & Barrel** [Pattern Repeats 2-3/8"]



PM8529 7/8 x 1-1/2 **Large Bead & Barrel** [Pattern Repeats 5"]



PM8532 1-1/8 x 2-3/4 **Large Laurel Leaf & Ribbon**
[Pattern Repeats 8"]



PM8535 3/4 x 1-1/2 **Small Egg & Dart** [Pattern Repeats 1-3/4"]



PM8536 1 x 2-3/4 **Large Egg & Dart** [Pattern Repeats 2-5/8"]



PM8538 13/16 x 1-1/2 **Egg & Dart**



PM8540 5/8 x 1 **Small Rope** [Pattern Repeats 3/4"]



PM8541 7/8 x 1-1/2 **Large Rope** [Pattern Repeats 1-1/4"]



PM8545 9/16 x 1 **Small Rope** [Pattern Repeats 3/4"]



PM8546 7/8 x 1-3/4 **Large Rope** [Pattern Repeats 1-1/4"]

Poplar Mon Reale® Panel Mold

(items are approximate scale only)



PM8552 13/16 x 2 **Reed & Ribbon** [Pattern Repeats 4-3/4"]



PM8564 7/8 x 2 **Medium Lamb's Tongue**



PM8553 1-1/8 x 2-3/4 **Reed & Ribbon** [Pattern Repeats 8"]



PM8565 9/16 x 1 **Small Lamb's Tongue**



PM8555 1-3/8 x 5-1/2 **Acanthus w/Pearl** [Pattern Repeats 4-1/2"]



PM8568 13/16 x 2-1/2 **Running Leaf with Beads**
[Lips 1/2" - 13/16"]



PM8569 13/16 x 2-1/2 **Ribbon & Reed** [Lips 1/2" - 13/16"]



PM8557 1-1/4 x 2-1/2 **Large Rope w/Pearls**



PM8571 1 x 3 **Egg & Dart** [Lips 1/8" - 13/16"]



PM8558 7/8 x 1-3/4 **Medium Rope w/Pearls**



PM8572 1-1/2 x 3-1/2 **Large Rope w/Pearls**
[Pattern Repeats 1-3/4"]



PM8560 7/8 x 2 **Medium Acanthus**



PM8573 13/16 x 2-1/2 **Small Acanthus Leaf**



PM8561 1/2 x 1 **Small Acanthus** [Lips 1/2" - 13/16"]

(items are approximate scale only)

Poplar Mon Reale® Frieze Mouldings



FR8968 13/16" x 6-3/4"
Flutes with Bellflowers Frieze Repeats 2-3/8" - MT = 13/16"



FR8970 3/4" x 8"
Classical Doric Frieze Repeats 7-3/4" - MT = 1"



FR8971 13/16" x 6-3/4"
Acanthus Leaf & Tongue Frieze Repeats 2-5/8" - MT = 1"



FR8980 1-1/16" x 6"
Large Acanthus Leaf & Scrolled Bellflowers



FR8982 1" x 4-1/2"
Medium Acanthus Leaf & Scrolled Bellflowers

4

Exciting New MDF Mouldings

- Collection features versatile Crowns, Friezes, and Panel Moulds
- Produced from Primed Pactrim domestic lightweight MDF
- Available in 16' lengths, unfinished
- New – Exciting ornamental designs
- Gorgeous high relief mouldings and a great value!

Beautiful Ornamentation Applied to 16' MDF
Here are our most popular designs and their dimensions for interior applications. Fine grain overlay contoured to a traditional primed MDF moulding, that you can stain, paint, or glaze.



CR13 Acanthus and Running Coin Crown
7/8" x 7" - pattern repeats 4-1/8"



CR14 Acanthus Crown
7/8" x 5-1/2" - pattern repeats 3-1/4"



FR15 Rinceau Scrolls Frieze
3/4" x 5" - pattern repeats 8-3/8"



FR16 Running Leaf and Bead Panel Mould
3/4" x 3" - pattern repeats 2-1/2"

Staining & Installation

(items are approximate scale only)

Steps to Staining Mouldings

ORIGINAL



Sand mouldings as you receive them.

STEP ONE



Apply one coat of latex primer.

STEP TWO



Brush thinned-out base stain evenly.

STEP THREE



Apply a stain glaze, wiping face lightly.

Notes on Staining

- Regular stain glazes are easier to work and have a softer effect.
- Heavy-bodied stain glazes are harder to work, but leave more color and intensity.
- Old Master™ and Mohawk™ are recognized brands that offer Gel Glazing stains.
- Always test finishes on a sample - White River does not warrant jobsite finishing.
- Depending on your finishing skills, spraying application with lacquer and glazing stains offer the same look!

INSTALLATION OF MOULDINGS WITH ORNAMENTAL MOTIFS |

- Installation of Door Casings: Cut head casings first so that ornamented pattern on side casing will miter into head casing. Center pattern so it miters evenly at both corners.
- Installation of Window Casings: Follow door casings, but install a window stool to add beauty and to avoid having to match four ornamented mitered corners (matching four mitered corners is easy if ornamentation is a delicate pattern).
- Installation of Crowns, Bases, and Chair rails: Install any outside corners first and work back into inside corners. If a single moulding has two motifs, match the largest motif first. If a moulding has dentil and embossing, match the dentil first and let the other motif match as well as possible. With Mon Reale and multiple motifs, you may have to make several "adjusting cuts" to find the best pattern match.

WELL-PROPORTIONED MOULDING DESIGNS |

Contrary to a misconception that large-scale mouldings make a room seem small, the opposite is true. Properly-proportioned mouldings enhance room scale and proportion by creating a sense of loftiness. In a room with 8' - 9' walls, large crowns appear to support and define the ceiling, thus increasing the feeling of height. Tall baseboards, wide casings, and ornate chair rails afford eye-catching architectural elements, fostering a comfortable and inviting environment.

CONCERNING OUR FRIEZES |

- MT indicates "Maximum Thickness" of moulding where overlay may be thicker than 13/16"
- Use backbands on page 338 with friezes to add additional width, depth, and detail.
- PM595 can be added to all friezes to provide symmetry. See panel mouldings on page 341.

RESINS |

When designing with resin, product can distort if cast to a radius that is too tight: see WhiteRiver.com for further specifications.

All curved components, whether resin or wood, take layout and thoughtful consideration for a successful installation.



Organized closets and garages are essential for today's busy lifestyle and add value to any home. To complete these projects, multiple options exist. The most widely used materials are particle board shelving and closet pole, however, wire shelving and melamine shelving are gaining popularity. With some ingenuity, you can create the same closets and garages that closet organizing companies design at a fraction of the cost.

section contents

| | |
|------------------------------------|-----|
| Brackets..... | 347 |
| Chrome Pole..... | 346 |
| Cleat..... | 347 |
| Closet Lining..... | 347 |
| Edge Banding..... | 347 |
| Closet Pole..... | 346 |
| Hook..... | 346 |
| Melamine Pre-drilled Dividers..... | 345 |
| Melamine Shelving..... | 345 |
| Plastic Shelf Supports..... | 347 |
| Pole Covers..... | 346 |
| Rosettes..... | 347 |
| Shelving..... | 345 |
| Support Bracket..... | 347 |





(items are approximate scale only)

Closet Material

| Melamine Shelving | | | |
|-------------------|---------------|----------------|-----|
| PART# | SIZE | STOCKED LENGTH | |
| MS1 | 5/8 x 11-1/4" | 8' | S |
| MS2 | 5/8 x 15-1/4" | 8' | S |
| MS3 | 5/8 x 23-1/4" | 8' | S |
| MS4 | 3/4 x 11-1/4" | 8' | N/S |
| MS5 | 3/4 x 15-1/4" | 8' | N/S |
| MS6 | 3/4 x 23-1/4" | 8' | N/S |

| Melamine Pre-Drilled Dividers | | | |
|-------------------------------|---------------|----------------|-----|
| PART# | SIZE | STOCKED LENGTH | |
| MD1 | 5/8 x 11-1/2" | 8' | S |
| MD2 | 5/8 x 15-1/2" | 8' | S |
| MD3 | 5/8 x 23-1/2" | 8' | S |
| MD4 | 3/4 x 11-1/2" | 7' | N/S |
| MD5 | 3/4 x 15-1/2" | 7' | N/S |
| MD6 | 3/4 x 23-1/2" | 7' | N/S |

| Unprimed Particle Board Shelving | | | |
|----------------------------------|----------------------------------|----------------|---|
| PART# | SIZE | STOCKED LENGTH | |
| 11PB-BN | 3/4 x 11-1/4" Bullnose | 12', 16' | N |
| 16PB-BN | 3/4 x 15-1/4" Bullnose | 12', 16' | N |
| 24PB-BN | 3/4 x 23-1/4" Bullnose | 12', 16' | N |
| 11PB | 5/8 x 11-1/4" Bullnose Tape Edge | 16' | S |
| 12PB | 5/8 x 15-1/4" Bullnose Tape Edge | 16' | S |
| 13PB | 5/8 x 23-1/4" Bullnose Tape Edge | 16' | S |
| 16PB | 3/4 x 11-1/4" Bullnose Tape Edge | 16' | S |
| 17PB | 3/4 x 15-1/4" Bullnose Tape Edge | 16' | S |
| 18PB | 3/4 x 23-1/4" Bullnose Tape Edge | 16' | S |



Closet Material

(items are approximate scale only)

| Unprimed MDF Shelving | | | |
|-----------------------|-----------------------------------|----------------|---|
| PART# | SIZE | STOCKED LENGTH | |
| 11MDF-F | 11/16 x 11-1/4" MDF S4S | 16' | N |
| 16MDF-F | 11/16 x 15-1/4" MDF S4S | 16' | N |
| 30MDF-F | 11/16 x 30-1/2" MDF S4S | 10', 16' | N |
| 11MDF-BN | 11/16 x 11-1/4" MDF Bullnose Edge | 16' | N |
| 16MDF-BN | 11/16 x 15-1/4" MDF Bullnose Edge | 16' | N |
| 11MDF-BN | 11/16 x 11-1/4" MDF Bullnose Edge | 16' | S |
| 12MDF-BN | 11/16 x 15-1/4" MDF S4S | 16' | S |
| 11MDF-2E | 11/16 x 11-1/4" MDF 2 Eased Edge | 16' | S |
| 12MDF-2E | 11/16 x 15-1/4" MDF 2 Eased Edge | 16' | S |
| 13MDF-F | 11/16 x 23-1/4" MDF Square Edge | 16' | S |

| Pine Shelving | | | |
|---------------|---------------------------|----------------|---|
| PART# | SIZE | STOCKED LENGTH | |
| PS | 11/16 x 11-1/4" #2 Common | 6' - 16' | S |

| Chrome Pole | | | |
|-------------|---------------------------|----------------|-----|
| PART# | SIZE | STOCKED LENGTH | |
| CPR | 1-1/16" Chrome Round Pole | 8', 12' | N/S |
| CPO | Chrome Oval Pole | 8', 12' | N/S |

| Fir & Pine Closet Pole | | | |
|------------------------|------------------------------|-----------------|-----|
| PART# | SIZE | STOCKED LENGTH | |
| F802 | 1-1/4" Fir Full Round | 6' - 20' | N/S |
| F802FJ | 1-1/4" FJ Fir Full Round | 16' + Trimbacks | N/S |
| F803 | 1-3/8" Fir Full Round | 6' - 20' | N/S |
| P802FJ / 802FJ | 1-1/4" FJ Pine Full Round | 16' + Trimbacks | N/S |
| 802SP | 1-5/6" Solid Pine Full Round | 6' - 16' | N/S |
| 803SP | 1-3/8" Solid Pine Full Round | 6' - 20' | S |

| Pole Covers | | | |
|-------------|--|----------------|-----|
| PART# | SIZE | STOCKED LENGTH | |
| PC | White Plastic Pole Cover (for 1-1/4 or 1-3/8" full round) | 12' | N/S |

| Hook | | | |
|-------------|--|----------------|-----|
| PART# | SIZE | STOCKED LENGTH | |
| 15FB | 9/16 x 3-1/4" IEE FB Hook | 16' | N/S |
| 15FJ | 9/16 x 3-1/4" FJ Pine Hookstrip | 16' | N/S |
| 16FJ | 11/16 x 4-1/2" FJ Rab't Hookstrip | 16' | N |
| MLH | 5/8 x 3-1/4" Melamine Hook 1-Edge Banded | 8' | N/S |
| CH | 3/4 x 3-1/2" #2 Common Pine Hook (1x4) | 3'-16' | S |

(items are approximate scale only)

Closet Material

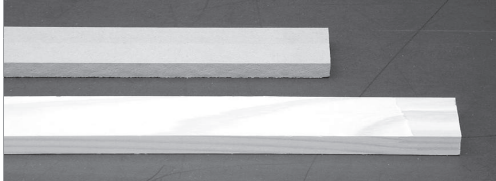
| Cleat | | | | | |
|---|--|-------------|---------------------------------|----------------|-----|
|  | | PART# | SIZE | STOCKED LENGTH | |
| | | 10FB | 9/16 x 1-1/2" IEE FB Cleat | 16' | N/S |
| | | 10FJ | 9/16 x 1-1/2" FJ Pine 1EE Cleat | 16' | N/S |

| Rosettes | | | | | |
|---|--|---------------|---|----------------|-----|
|  | | PART# | SIZE | STOCKED LENGTH | |
| | | CRR | Chrome Rosette w/Nipple (use w/chrome pole-round) | — | N/S |
| | | CRO | Chrome Rosette w/Nipple (use w/chrome pole-oval) | — | N/S |
| | | CRO-NO | Chrome Rosette No Nipple (use w/chrome pole-oval) | — | N/S |
| | | WR | Wood Rosette (100 PR p/box) | — | N/S |
| | | PR | Plastic Rosette (2 PCS. p/bundle) | — | N/S |

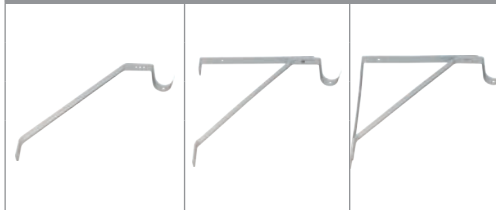
| Brackets | | | | | |
|--|--|-------------|-------------------------------------|----------------|-----|
|  | | PART# | SIZE | STOCKED LENGTH | |
| | | 4750 | Brackets (80 Pcs. p/box) | — | N/S |
| | | 4700 | Swivel End Brackets (20 Pcs. p/box) | — | N/S |
| | | 4800 | Heavy Duty Brackets (20 Pcs. p/box) | — | N/S |

| Support Bracket | | | | |
|---|--|--------------|---|----------------|
|  | | PART# | SIZE | STOCKED LENGTH |
| | | CPS-O | Chrome Oval Pole Support Bracket - (Oval Pole Only) | — |

| Plastic Shelf Supports | | | | |
|---|--|-----------|------------------------|----------------|
|  | | PART# | SIZE | STOCKED LENGTH |
| | | SS | Plastic Shelf Supports | 12 Pcs./Bag |

| Aromatic Cedar Closet Lining | | | | | |
|---|--|------------|--|----------------|---|
|  | | PART# | SIZE | STOCKED LENGTH | |
| | | 3CL | 5/16 x 3-7/8" Aromatic Cedar T&G Closet Lining | 8' | S |
| | | 4CL | 5/16 x 4-7/8" Aromatic Cedar T&G Closet Lining | 8' | S |

| Edge Banding | | | | | |
|---|--|------------|-------------------|----------------|-----|
|  | | PART# | SIZE | STOCKED LENGTH | |
| | | EB1 | 5/8" Edge Banding | 250' Roll | S |
| | | EB2 | 3/4" Edge Banding | 250' Roll | N/S |

Big Ideas

(items are approximate scale only)



Pockets/Frames/ Composite Millwork



A FRAME FOR EVERY KIND OF OPENING



EL & EL Pocket Door Sliders are manufactured on our premises using a combination of track and hardware options: CoxUSA can hold door weights up to 150# or 225# with standard steel track. An optional upgrade is available for aluminum track that creates a quieter, stronger track. New, from Johnson Hardware, is 200# hardware that comes standard with aluminum track and offers an optional upgrade of a soft-close in or out feature. Also available is Häfele's track and hardware, "SlidoClassic" and Hawa Jr. 80/Z – an ADA approved pocket slider, that can hold up to 176# or 264# with anti-bounce back, aluminum track and easy removable track.

Composite frames and components offer an alternative choice to traditional wood door frames. Moisture, rot and insect resistant, this unique exterior door jamb and components will not absorb or wick moisture and never warp or splinter.

Framesaver offers traditional wood door frames that have a composite on the bottom 4", repelling moisture and wicking.

section contents

| | |
|---|-----|
| Brick Mold w/Stucco Key | 352 |
| Composite Exterior Frames & Mouldings | 351 |
| Frame Saver Door Frames..... | 351 |
| Kerfed T-Astragal..... | 352 |
| Mitered Brick Mold..... | 352 |
| Mull Covers | 352 |
| Pocket Sliders | 349 |
| Primed Composite Frames | 350 |
| Sidelite Stop | 352 |
| Track & Hardware Options..... | 349 |

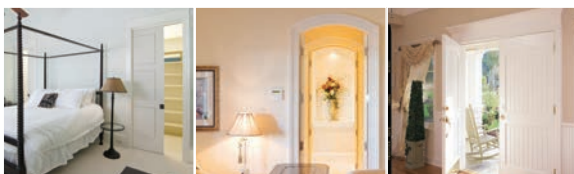

Pockets/Frames/ Composite Millwork

A FRAME FOR EVERY KIND OF OPENING



Pocket doors are an elegant and space-saving way to provide privacy and separate rooms.

FJ Pocket Sliders are available in standard sizes for next day delivery and other species are custom made to order. All wood parts of a pocket slider are made of pine, however, the finish (visible wood components) vary according to the specie ordered. Pocket sliders are available in paint grade, VG Doug Fir, Red Oak, Cherry, Mahogany, Alder and more. Door hanging hardware is included with each pocket slider, however, hardware for the door handle is not included.

We are pleased to now offer, as an upgraded option, Häfele track and hardware, considered the 'Cadillac' in sliding performance and ADA compliance. Suitable for door weights from 176lbs. to 264lbs., the sliding hardware requires less than 5lbs. of closing force. Also ADA compliant is the Hawa Jr-8oz. that provides superior quality and German engineering. (A non ADA compliant hardware that holds up to 528lbs. is also available.) Please note the spec variance from our standard pocket sliders when using Häfele track and hardware.

Composite frames and components offer an alternative choice to traditional wood door frames. Moisture, rot and insect resistant, this unique exterior door jamb and components will not absorb or wick moisture and never warp or splinter. A door frame with integrity today, tomorrow and years down the road. Door hinges are available in a wide selection for residential and commercial applications. Representing the best value in door hinges today. All items shown are in stock and ready to ship to your exact requirements.

NEW OPTIONS NOW AVAILABLE

Aluminum Track: softer, smoother, quieter ride

Soft-close Doors: easier, smoother opening and/or closing

Synchronized Double Doors: both doors move in tandem

space-savings

smooth transitions

beautifully private



(items are approximate scale only)

Pocket Sliders

Lengths available: all 6' thru 16'

Pocket Body Options



* The standard gap for a pocket slider door is 2" wide and works well for 1-3/8" doors. Slats are 3/4" common pine.

* 1-3/4" doors have a non standard gap that is 2-1/4" and may alter wall conditions by 1/4".



* Special order 1-3/4" doors = 1/2" ply slats on both sides with steel horizontal stiffeners creates a 2-1/4" gap and does not alter the wall condition.



FULL PLY

- The minimum pocket slider wall thickness is 3-1/2"
- Kerfed for bullnose pocket sliders available on special order.
- Options available:
 - 1) Aluminum track & stiffeners
 - 2) Hardware options for CoxUSA and Häfele Jr door weights are 150#, 176#, 200#, 225# and 528#
 - 3) 3-1/2", 10", 24" ply slats or full ply sides
 - 4) Steel or aluminum stiffeners on slats

Use Pocket Door Sliders:

- In rooms or areas where there isn't enough space for the door to swing
- To separate rooms with doors that can be hidden into the wall but also closed for privacy or separation
- As an architectural effect

Standard pocket door sliders are available in FJ Pine and VG Douglas Fir, Solid Pine, Red Oak, Poplar, Alder, and Cherry. Other species are available by special order.

Track & Hardware Options

CoxUSA Pockets (150 lbs. & 225 lbs.)

Our standard pocket is CoxUSA 150 lbs. which includes a steel 'C' track and 4-wheel axle hardware. Aluminum track is an upgrade option, with both 150 lbs. or 225 lbs. hardware. 225 lbs. pockets include a steel 'C' track and ball bearing hardware.

Johnson Hardware Pocket (200 lbs. Capacity)

Includes aluminum track and 3-Wheel Axle hardware with soft close option.

Häfele Hardware Pocket (170 lbs., 264 lbs. & 528 lbs. Capacity)

Includes aluminum track, 4-wheel ball bearing hardware with Quick Release and anti-bounce back stop. (Please note that 528 lbs. capacity hardware does not meet ADA compliance)

*Häfele Hawa Jr. 80/Z

German engineered to handle door weights up to 176 lbs., Hawa Jr. is the "Cadillac" of pocket door track and hardware. ADA approved anodized aluminum track with a soft close option, rattle-free bottom door guide, four (4) nylon wheeled running gear, and an adjustable tension anti-bounce back stop.

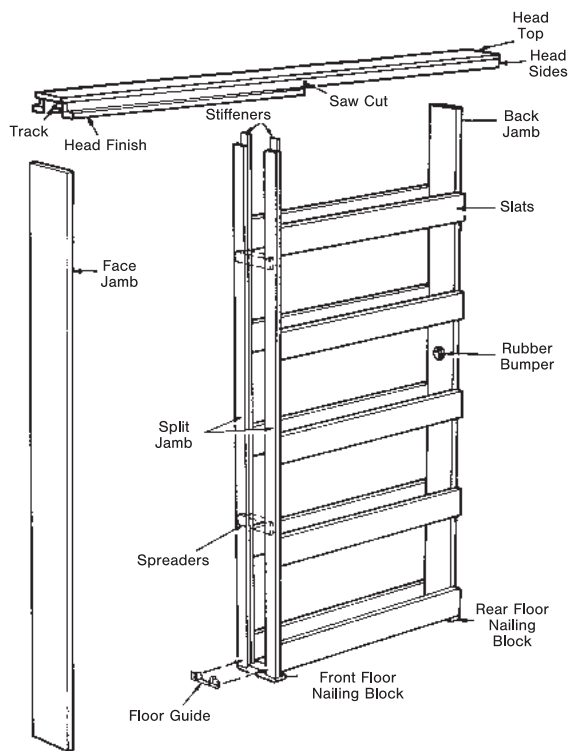

| Finish Door Size (Single Door Opening) | | 2' - 0" | 2' - 4" | 2' - 6" | 2' - 8" | 3' - 0" |
|---|--------|--------------|--------------|--------------|--------------|--------------|
| Rough Opening | Height | 7' - 0" | 7' - 0" | 7' - 0" | 7' - 0" | 7' - 0" |
| | Width | 4' - 2" | 4' - 10" | 5' - 2" | 5' - 6" | 6' - 2" |
| Frame Size | Height | 6' - 11-5/8" | 6' - 11-5/8" | 6' - 11-5/8" | 6' - 11-5/8" | 6' - 11-5/8" |
| | Width | 4' - 1-5/8" | 4' - 9-5/8" | 5' - 1-5/8" | 5' - 5-5/8" | 6' - 1-5/8" |

For Double Doors

The rough opening on a Double Pocket is 4X the size of a single door + 1-1/2". Height is the same as listed for a single door pocket slider.

Using Häfele Tracking Hardware

The rough opening on a Single Door is 2X the door width + 2". Rough opening height is the door height + 5". A Double pocket door rough opening is 4X door + 1-1/2".

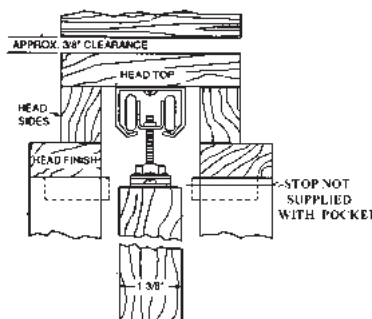

1. INSTALL HANGERS

Prior to installation, place hangers in track by fitting through hanger mounting space between track and jamb.

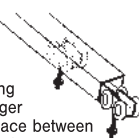

2. INSTALL HANGER BRACKETS

Screw all hanger brackets on door, 2-3/4" from edge of door to center of bracket.

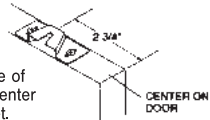

3. INSTALL AND ADJUST DOORS

Attach bracket to hanger by lifting door and inserting adjusting bolt into slot until bolt head becomes seated. Align doors by turning adjusting bolt with wrench. After final adjustment, tighten lock nut down to bracket as shown.

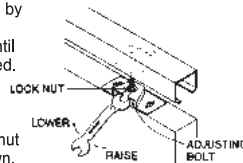

4. INSTALL FLOOR GUIDES

Nail nylon guide No. 04-002 to split jamb as shown, centering door in pocket.
NOTE: For 1-3/4" doors, cut out center section of nylon floor guide.



Primed Composite Frames

 lengths available: all 6' thru 16'

(items are approximate scale only)

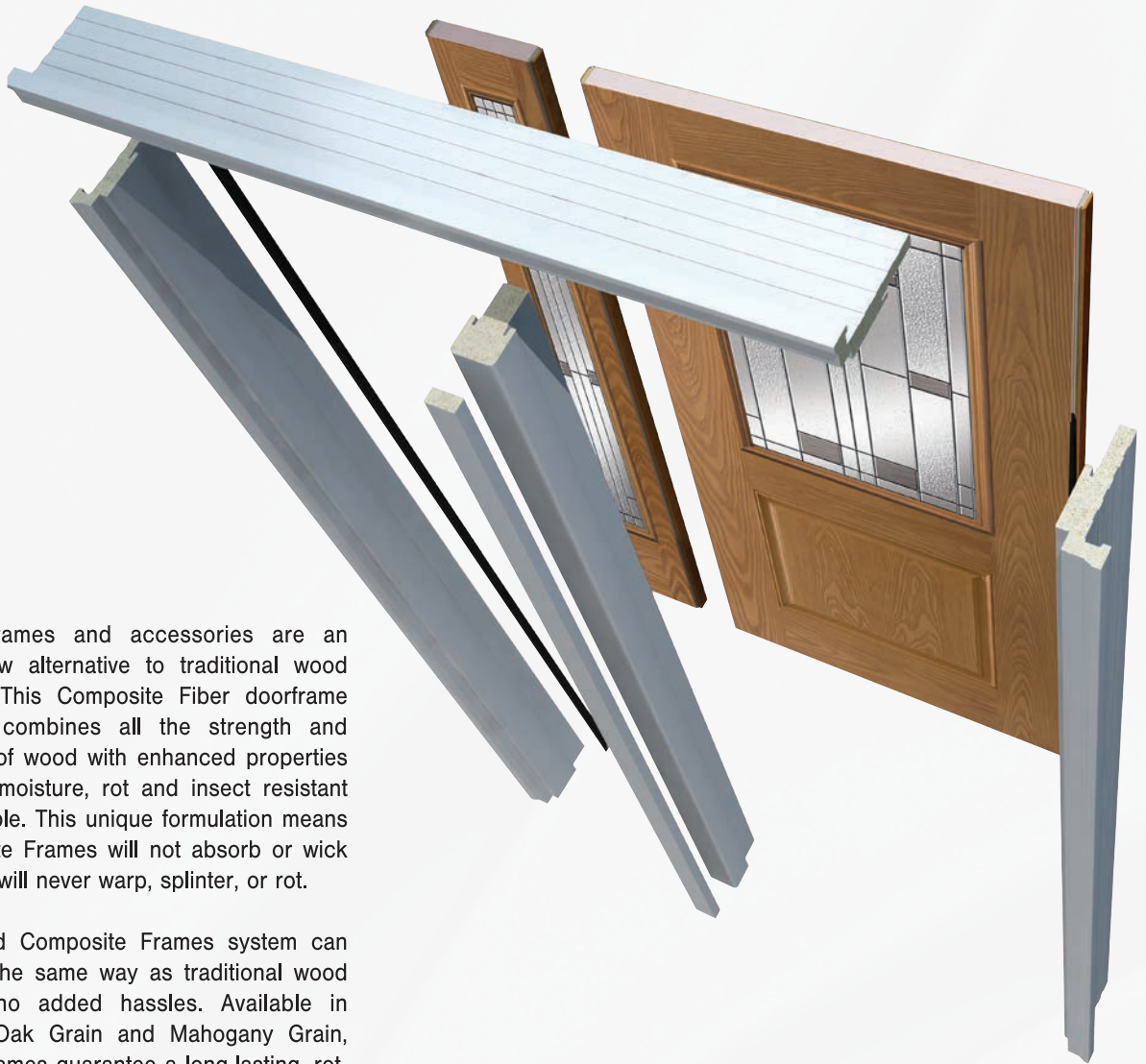

Composite frames and accessories are an innovative new alternative to traditional wood door jambs. This Composite Fiber doorframe system that combines all the strength and convenience of wood with enhanced properties that make it moisture, rot and insect resistant is now available. This unique formulation means that Composite Frames will not absorb or wick moisture and will never warp, splinter, or rot.

The advanced Composite Frames system can be matched the same way as traditional wood jambs with no added hassles. Available in Paint-grade, Oak Grain and Mahogany Grain, Composite Frames guarantee a long-lasting, rot-free entryway that will maintain its integrity today, tomorrow, as well as years down the road.

COMPOSITE FRAMES FEATURES & BENEFITS

CLOSED CELLULAR STRUCTURE ensures doorframe & molding will not absorb or wick moisture, and prevents warping, rotting and splitting

RIGID COMPOSITE FIBER FORMULATION eliminates the need for an aluminum support channel

TWICE THE SCREW-HOLDING POWER of traditional wood doorframes

EASILY MACHINED just like wood frames

VARIOUS LENGTHS

(items are approximate scale only)

Composite Exterior Frames & Moulding

 solid pine jamb lengths: 11/16" x 3-15/16" 6' thru 16'

Composite Door Frames

- Will Not Rot
- Insect Resistant

Primed **(CF)** Composite Fiber
 Oak Woodgrained **(WG)** Composite
 Mahogany **(MHG)** Composite

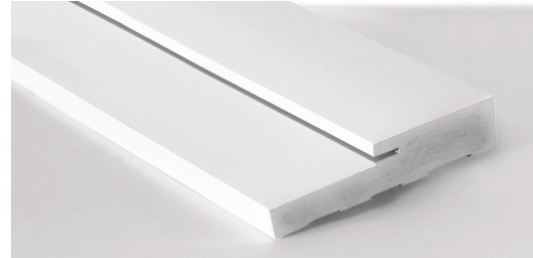

All frames are kerfed for weatherstrip

6/8 Frames: 81-1/4 BD x 1-1/4 x 1/2 x 2-1/8"

8/0 Frames: 97-1/4 BD x 1-1/4 x 1/2 x 2-1/8"

For a full set (head + 1 pair of sides), please order 1.5 pairs (1-1/2 pairs).

- WILL NOT ROT
- INSECT RESISTANT

| Exterior Door Frames | | | | | | | |
|----------------------|-----------------|----------|------------------------------------|----------|---------------------------------------|-----------|------------|
| SIZE | Paintgrade (CF) | | Woodgrain (WG) (stain or paint) | | Mahogany Poly Fiber Frames™ (MHPG) | | |
| | 6/8 | 8/0 | 6/8 | 8/0 | 6/8 | 8/0 | 20/0 |
| 4-9/16 | CF4916W6 | CF4916W8 | WG4916W6 | WG4916W8 | MHG4916W6 | MHG4916W8 | MHG4916W20 |
| 5-1/4 | CF514W6 | CF514W8 | WG514W6 | WG514W8 | MHG514W6 | MHG514W8 | - |
| 6-9/16 | CF6916W6 | CF6916W8 | WG6916W6 | WG6916W8 | MHG6916W6 | MHG6916W8 | MHG6916W20 |
| 7-1/4 | CF714W6 | CF714W8 | WG714W6 | WG714W8 | MHG714W6 | MHG714W8 | MHG714W20 |

*20' stock sold per piece only.

Frame Saver Door Frames

Frame Saver Door Frames

Primed FJ with a 4" rot-proof wood composite on bottom of each frame leg, keeping water & moisture from wicking into the wood frame.

| SIZE | 6/8 | 8/0 |
|--------|----------|----------|
| 4-9/16 | FS4916W6 | FS4916W8 |
| 5-1/4 | FS514W6 | FS514W8 |
| 6-9/16 | FS6916W6 | FS6916W8 |
| 7-1/4 | FS714W6 | FS714W8 |



Door Trim

(items are approximate scale only)

✂ lengths available: all 6' thru 16'

(CF) Composite Fiber

(UR) Urethane

(WG) Oak Woodgrained Composite Fiber

- WILL NOT ROT
- INSECT RESISTANT

| 7/8" x 1-1/2" Stucco Mold | | |
|---|--------------|----------|
| | PART # | LENGTH |
|  | UR953 | 7' & 17' |
|  | CFSM | 18' |

| 1" x 2" Mull Cover | | |
|--|-----------------|--------|
| | PART # | LENGTH |
|  | CFMULLC8 | 8' 0" |
| | WGMULLC8 | 8' 0" |

| 1-1/4" x 2" WM180 Brick Mold (w/Stucco Key) | | |
|---|---------------|----------|
| | PART # | LENGTH |
|  | UR612B | 7' & 17' |
|  | CFBKMK | 17' |

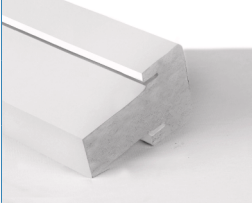
| 1 x 2" x 4-3/8" Primed LVL Mull Post | | |
|---|----------------------|--------|
| | PART # | LENGTH |
|  | PGLVL438MULL8 | 8' 0" |

| 1-1/4" x 2" WM180 Mitered Brick Mold (no key) | | |
|---|---|--------|
| | PART # | LENGTH |
|  | CFBKM6 <small>(Mitered 82-15/16")</small> | 6' 8" |
| | CFBKM8 <small>(Mitered 98-15/16")</small> | 8' 0" |
| | WGBKM6 <small>(Mitered 82-15/16")</small> | 6' 8" |
| | WGBKM8 <small>(Mitered 98-15/16")</small> | 8' 0" |

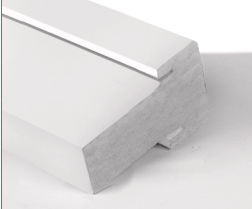
| 1-1/2" x 2-1/2" x 4-3/8" LVL Primed Fat Boy Mull Post | | |
|--|----------------------|--------|
| | PART # | LENGTH |
|  | PGLVL212MULL8 | 8' 0" |

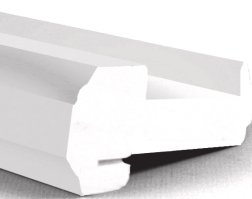
| 1-1/2" x 3-1/4" Kerfed T-Astragal | | |
|---|---|--------|
| | PART # | LENGTH |
|  | CFAST8 <small>(Formerly PCAST8)</small> | 8' 0" |
| | WGAST8 | 8' 0" |

| 3/8" x 5/8" Sidelite Stop | | |
|--|-----------------|--------|
| | PART # | LENGTH |
|  | CFSLSTOP | 99" |
|  | WGSLSTOP | 99" |



Your home is a reflection of who you are. That's why we've designed a range of doors and glass options to help express a character that is undeniably yours.

EL & EL and our partners have come together to offer the most comprehensive line of Interior Door Units in the market place today. Choose from trusted brands like Simpson, Masonite, Trimlite or CoxUSA in a wide variety of species, available in a multiplicity of sizes for every opening and every taste. **Explore all your options inside our complete Door Catalog or visit us online at ELandELWoodProducts.com.**

section contents

| | |
|------------------------------------|-----|
| Barn Door Collection | 357 |
| Dividers by CoxUSA™ | 357 |
| Masonite® Knotty & Clear Pine..... | 355 |
| Masonite® Moulded..... | 356 |
| Primed & Pine Louver | 354 |
| Raised Panel Moulding MDF..... | 353 |
| Shaker Series..... | 354 |
| Simpson® Interior..... | 355 |
| Superior & Knotty Alder | 353 |
| Trimlite Decorative | 356 |

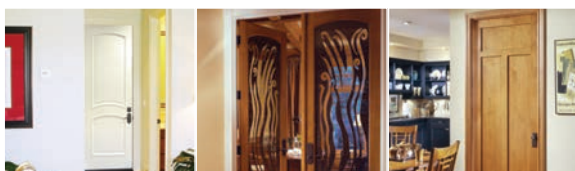

Interior Doors

DESIGN STYLES

ALL

**JANKA
HARDNESS**
(POUNDS-FORCE)

I
varies

PREP

- 1 Before applying the first coat of finish, remove all handling marks, any raised grain and other undesirable blemishes by sanding all surfaces with 180 grit sandpaper. (For doors with shaker sticking, lightly ease the outside edge of the sticking with sandpaper.) To avoid cross-grain scratches, sand with the grain.
- 2 After sanding, clean door thoroughly with a cloth to remove all dust or foreign material. Do not use caustic or abrasive cleaners.
- 3 Adjust or align components, if necessary, before finishing. Wood panels “float” and may be knocked into alignment with a wood block and hammer. Be careful not to damage door.
- 4 Hang door before finishing, and then remove to finish properly. All surfaces of the door must be properly finished. The edges (top, bottom and sides) should be coated with each and every coat of finish that is applied to the exterior surface of the door. Doors must be properly sealed prior to installation of hardware and exposure to moisture or weather. Doors must be dry before finishing. Properly finish door immediately before prolonged storage.
- 5 On doors that are glazed with clear glass, the finish used should be flowed from the wood slightly onto the glass. This will provide assurance against water leakage and protect the glazing compound “putty” from drying out. It is the finisher’s responsibility to protect glass prior to and during finishing. If using tape, conduct a test of the tape being used on a small area of the glass before applying to a large surface. After finishing, remove the tape as soon as possible.

ALWAYS PROPERLY FINISH ALL SIDES AND EDGES OF YOUR DOOR. **ALWAYS** PROPERLY SEAL YOUR DOOR BEFORE ADDING HARDWARE OR EXPOSING TO MOISTURE OR WEATHER. **ALWAYS** PROPERLY FINISH YOUR DOOR BEFORE PROLONGED STORAGE.

FINISHING

Your new door has been crafted with only the finest materials and you can choose from a wide variety of stains or paint possibilities.

Paint dealers have a broad selection of color chips on hand to demonstrate the look you can achieve when staining fine wood i.e. Douglas Fir or Pine or if you are painting, you can apply either oil-base or acrylic resin-based paints over an oil-base primer.

Take care in following the manufacturers finishing instructions. Always be sure to evaluate the conditions your door must endure before deciding on the specific finish to use.

All doors must be finished shortly before or after installation.

FITTING & HANGING

- * When hanging a door, allow adequate clearance for any swelling of door or frame in damp weather.
- * Allow approximately 3/16” clearance for swelling when the door is installed in fully dry conditions.
- * Jams must be plumb.
- * Avoid excessive warping or drying. Do not store or install your door in a damp or freshly dry-walled building.
- * Keep the door at least 10 feet away from heating registers, and away from direct sunlight.
- * Do not cut doors down in height by more than the allowable amount per each manufactures specifications. Care should be taken in cutting doors down in width to avoid exposing engineered components.
- * Use a sharp fine-tooth saw for trimming edges and ends of doors. Jams and stops must be set square and plumb.



Raised Panel Moulding MDF Doors



(TB2 shown)

6/8 and 8/0 1-3/4" thick

- Hand-built construction for an architecturally correct raised panel and raised moulding design – better value than typical wood doors
- 1-3/4" solid core door provides a much quieter environment than lighter weight hollow core doors
- "Seamless Construction" - one piece solid MDF veneer eliminates seam separation, typical in stile and rail construction
- Finger joint pine edge, along the top rail and stiles and full 3-1/8" solid wood edge at the bottom rail, allows for jobsite trimming on all sides for a custom fit
- Premium lacquer-based primer is standard
- Environmentally friendly materials
- No warping, cracking or seam separations
- Flush moulding door available for bypass and pocket doors

FIRE DOOR OPTION AVAILABLE ON 2/8 and 3/0 DOORS.



Superior & Knotty Alder Doors



(SA002 shown)

6/8 and 8/0 1-3/8" & 1-3/4" thick

- Superior and Knotty Alder doors are available in interior and exterior Arch Top 2-panel
- Knotty Alder doors also available in Square Top Shaker and 1-lite styles
- Engineered stiles and rails are sturdier and less susceptible to warping and bending in the life of a door. The appearance is the same as non-engineered stiles and rails, but the core is made up of multiple pieces of wood for improved strength and durability.

TWO PANEL 20-MINUTE POSITIVE PRESSURE FIRE RATED DOOR OPTIONS AVAILABLE



EXPLORE ALL DOOR OPTIONS IN THE EL & EL DOOR CATALOG OR ONLINE AT ELandELWoodProducts.com

Shaker Series Doors



(SH782 shown)

6/8, 7/0 and 8/0 1-3/8" & 1-3/4" thick

- Premium Primed Square and Ovolo Sticking
- Craftsman style options in Vertical Grain Doug Fir, Square and Ovolo Sticking
- Bi-fold options in Primed and Vertical Grain Doug Fir
- MDF overlayed on a wood lumber core

FIRE DOOR OPTIONS AVAILABLE

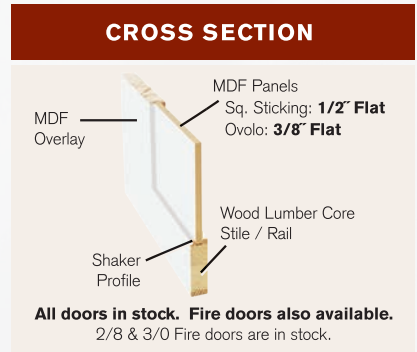

Primed & Pine Louver Doors



(PBPLL shown)

6/8 and 8/0 1-3/8" thick

- 1-3/8" Louver Interior Doors available in louver-louver or louver-panel Pine and primed MDF
- Bi-fold, Plantation and Louver Shutter door options
- Bi-fold doors include easy instructions, knobs, hardware, track and aligner to install as 4-door unit.



EXPLORE ALL DOOR OPTIONS IN THE EL & EL DOOR CATALOG OR ONLINE AT ElandELWoodProducts.com

Knotty and Clear Pine Doors



(K2PA shown)



6/8 and 8/0 1-3/8" thick

- Real wood doors designed to accentuate any room
- Featuring traditional & contemporary panel configurations
- Stain or clear coat to complement your décor
- Available as a Bifold and Fire Door
- Available as Clear Pine (no knots)

20-MINUTE POSITIVE PRESSURE FIRE RATED DOOR OPTIONS AVAILABLE



Simpson® Interior Doors



(CUSTOM DOOR shown)



- FRENCH DOORS - All French doors are stocked in Douglas Fir or Redi-Prime® (as noted) with 1/8" SG, 1-3/8" thick, 6'8" height unless otherwise noted, widths as indicated.
- RAISED PANEL DOORS - All raised panel doors are stocked in Douglas Fir with a 3/4" double hip-raised panel, 1-3/8" thick, 6'8" height and widths as indicated.
- FLAT PANEL DOORS - All raised panel doors are stocked in Douglas Fir with a 3/4" flat panel, 1-3/8" thick, ovolo sticking 6'8" height and widths as indicated.
- SPECIAL ORDER & CUSTOM DOORS - Whatever your project needs are, Simpson can build the door to your exact specifications. Any Design. Any Size. Any Shape. Any Wood Species. Visit the Simpson Doormagination® tools at simpsondoor.com/doormagination.

FIRE RATED DOOR OPTIONS AVAILABLE



EXPLORE ALL DOOR OPTIONS IN THE EL & EL DOOR CATALOG OR ONLINE AT ElandELWoodProducts.com

Trimlite Decorative Doors



(RAW SILK shown)



6/8 and 8/0 1-3/4" thick

- Interior home decor is a very personal thing. Finding the style that reflects your wants and compliments your living space is very important. Our design team understands this. From our selection of French doors with glass installments to our interior shaker panel doors, you will find a style that is a true reflection of your taste.
- Choose from French to Shaker to Mid Century Modern and beyond. Bubbles, lines, slight surface imperfections or discolourations are characteristics of all hand crafted glass. They are not considered defects; they add character.



Masonite® Molded Door Collection



(BERKLEY shown)



Five distinct categories make it easy to match your unique style.

- Classics™, Heritage®, Select™ and Palazzo® are all Finger Joint Stiles and also available as bifold doors.
- The West End Collection complements your modern or contemporary style.
- Engineered design provides stability and value to better withstand the dents and dings associated with normal wear and tear.
- Making the move to solid core doors blocks sound more effectively when privacy is key.

FIRE RATED DOOR OPTIONS AVAILABLE

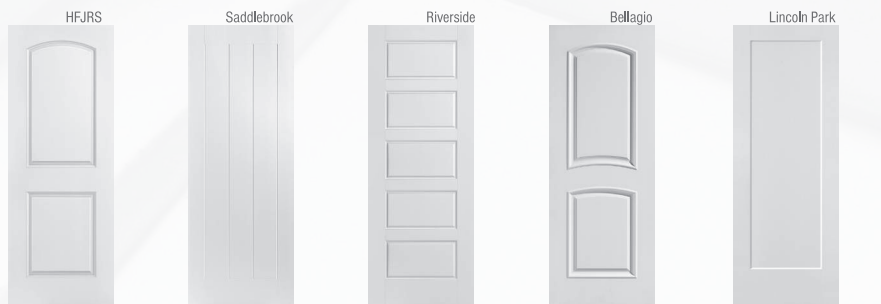

EXPLORE ALL DOOR OPTIONS IN THE EL & EL DOOR CATALOG OR ONLINE AT ElandELWoodProducts.com

Dividers by CoxUSA



DIVIDERS by COXUSA

- Available in single, double, triple, and quad panel systems
- Available with 4 standard glass options: Mirror, White Lami, Polar White, Black
- Offered in 4 standard frame finishes: Black, White, Java, and Satin Aluminum
- Optionally choose from 4 decorative rail options: 2-lite, 3-lite, 4-lite, and 5-lite
- ADA standards compliant for push/pull force
- Latches and pulls for privacy and passage applications
- 150 lbs. maximum panel weight



Barn Door Collection



(180 shown)

2/6, 3/0, 3/6 x 7/0 and 8/0 1-3/8" thick

- Choose from three unique styles, species and hardware options
- Center/cross mulls, that are full thickness, insure the stile meets flush at the stile and rail joints for a truly custom finish
- Deeper V-Grooves accentuate the plank style and design
- Panels are 3/4" edge glued for durability and strength

SPECIES



Primed MDF



Knotty Alder



Knotty Pine



180



181



183

HARDWARE

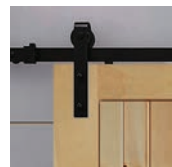

EXPLORE ALL DOOR OPTIONS IN THE EL & EL DOOR CATALOG OR ONLINE AT ElandELWoodProducts.com



Big Ideas



Big Ideas



Big Ideas



Exterior Doors

SOUNDNESS. STABILITY. CHARACTER.



The entryway – where you greet family and friends. An important focal point that enhances curb appeal and adds value to your home. That’s why we’ve created an extensive collection of doors and accessories, making it easy for you to make an opening statement.

EL & EL and our partners have come together to offer the most comprehensive line of Exterior Door Units in the market place today. Choose from trusted brands, like Simpson, for a wide variety of species, sizes and styles, for every opening and every taste. **Explore all your options inside our complete Door Catalog or visit us online at ELandELWoodProducts.com.**

section contents

| | |
|---|-----|
| Fiberglass Exterior Doors | 361 |
| Knotty Alder Exterior Doors | 364 |
| Modern Door Collection..... | 363 |
| Doorlites | 361 |
| Prefinished Fiberglass Doors..... | 362 |
| Rediframe® Prefinished Steel Door Frames..... | 364 |
| Retrofit Patio Doors..... | 362 |
| Simpson® Exterior Wood Doors..... | 363 |



Exterior Doors

DESIGN STYLES

ALL

JANKA
HARDNESS
(POUNDS-FORCE)

E
varies

PREP

- 1 Before applying the first coat of finish, remove all handling marks, any raised grain and other undesirable blemishes by sanding all surfaces with 180 grit sandpaper. (For doors with shaker sticking, lightly ease the outside edge of the sticking with sandpaper.) To avoid cross-grain scratches, sand with the grain.
- 2 After sanding, clean door thoroughly with a cloth to remove all dust or foreign material. Do not use caustic or abrasive cleaners.
- 3 Adjust or align components, if necessary, before finishing. Wood panels “float” and may be knocked into alignment with a wood block and hammer. Be careful not to damage door.
- 4 Hang door before finishing, and then remove to finish properly. All surfaces of the door must be properly finished. The edges (top, bottom and sides) should be coated with each and every coat of finish that is applied to the exterior surface of the door. Doors must be properly sealed prior to installation of hardware and exposure to moisture or weather. Doors must be dry before finishing. Properly finish door immediately before prolonged storage.
- 5 On doors that are glazed with clear glass, the finish used should be flowed from the wood slightly onto the glass. This will provide assurance against water leakage and protect the glazing compound “putty” from drying out. It is the finisher’s responsibility to protect glass prior to and during finishing. If using tape, conduct a test of the tape being used on a small area of the glass before applying to a large surface. After finishing, remove the tape as soon as possible.

ALWAYS PROPERLY FINISH ALL SIDES AND EDGES OF YOUR DOOR. ALWAYS PROPERLY SEAL YOUR DOOR BEFORE ADDING HARDWARE OR EXPOSING TO MOISTURE OR WEATHER. ALWAYS PROPERLY FINISH YOUR DOOR BEFORE PROLONGED STORAGE.

FINISHING

Your new door has been crafted with only the finest materials and you can choose from a wide variety of stains or paint possibilities.

Paint dealers have a broad selection of color chips on hand to demonstrate the look you can achieve when staining fine wood i.e. Douglas Fir or Pine or if you are painting, you can apply either oil-base or acrylic resin-based paints over an oil-base primer.

Take care in following the manufacturers finishing instructions. Always be sure to evaluate the conditions your door must endure before deciding on the specific finish to use.

All doors must be finished shortly before or after installation.

FITTING & HANGING

- * When hanging a door, allow adequate clearance for any swelling of door or frame in damp weather.
- * Allow approximately 3/16” clearance for swelling when the door is installed in fully dry conditions.
- * Jambs must be plumb.
- * Avoid excessive warping or drying. Do not store or install your door in a damp or freshly dry-walled building.
- * Keep the door at least 10 feet away from heating registers, and away from direct sunlight.
- * Do not cut doors down in height by more than the allowable amount per each manufactures specifications. Care should be taken in cutting doors down in width to avoid exposing engineered components.
- * Use a sharp fine-tooth saw for trimming edges and ends of doors. Jambs and stops must be set square and plumb.



BMT-122-817-1



BLS-122-152-725-T



BLS-122-928-X



Fiberglass Exterior Doors



(Barrington Craftsman Oak textured 3 panels with Marco Glass)

Craftsmanship

It's traditional craftsmanship meets new world technology that makes Fiberglass Entry Doors the most advanced products available on the market today.

Quality

Innovative manufacturing methods include our fully integrated, computer-controlled system that enables greater product consistency and enhanced employee safety.

Reliability

Fiberglass exterior doors have been put through a rigorous battery of tests, first in their own testing lab and again by an independent facility.

Choice

Choose from the widest range of styles, textures and sizes found anywhere.



Doorlites



(BLW-404-817-1)

Upgrade Your Entry with Privacy and Style

- Accented with several varieties of decorative glass components and coming options.
- Fused between two panes of clear tempered glass for added energy efficiency and strength.
- Achieve your desired level of privacy with frosted glass, powerful bevels, cordless mini-blinds or ornate coming.

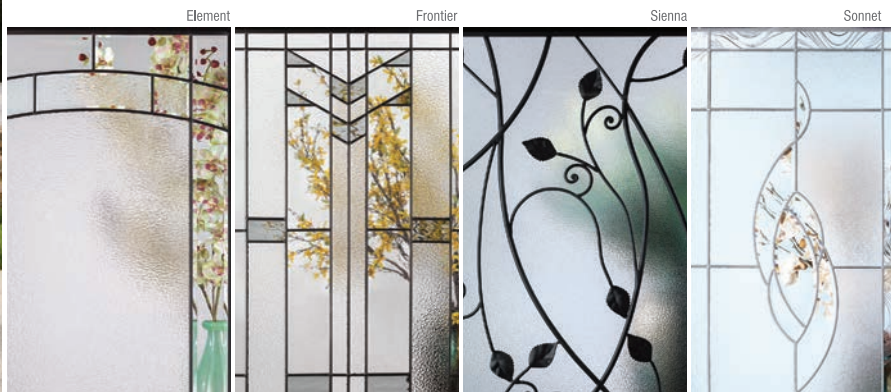

EXPLORE ALL DOOR OPTIONS IN THE EL & EL DOOR CATALOG OR ONLINE AT ELandELWoodProducts.com

Prefinished Fiberglass Doors - Color Options



(Belleville® Hollister® Smooth with Chelsea® Glass / Door BLS-404-341-1)

FEATURES

- Prefinishing Available on all Four Wood Grain Styles
- 9 Standard Stains, 10 Standard and 6 Contemporary Paint Color Options
- Custom Colors Available Using the Dunn Edwards Paints Color Palette
- Split Finishes Available
- 2 Year Limited Warranty (*Residential Only*)

STANDARD TEXTURED FIBERGLASS STAIN COLORS (Shown in Oak Grain)



CONTEMPORARY CLASSIC PAINT COLORS

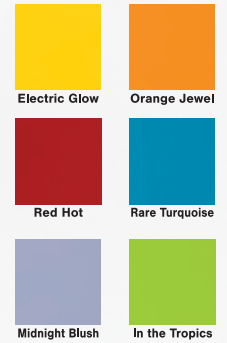

STANDARD PAINT COLORS

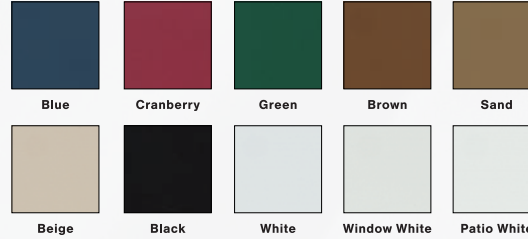

EXPLORE ALL DOOR OPTIONS IN THE EL & EL DOOR CATALOG OR ONLINE AT ElandELWoodProducts.com

EL & EL Elite Series Retrofit Patio Doors



FEATURES

- Single, Double, Triple or Quad Door Styles
- Low-E, Raise-Lower-Tilt Mini Blinds
- Five Handle Designs in Five Popular Finishes
- Weather-resistant Door Frames
- Easy-locking Multi-point Sidelights
- The Ultimate Performance Glass

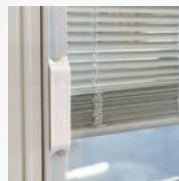

Optional Handle Sets

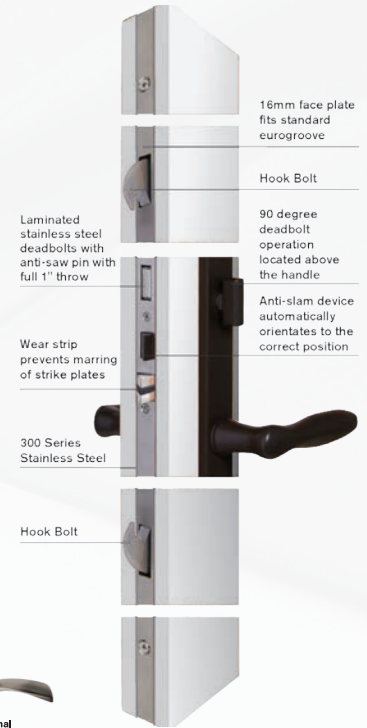

Modern Door Collection



- Expertly blended simplicity with stark design
- The sky is the limit with creativity and personalization—choose from numerous decorative glass and finish options.
- Finish your new door with the perfect hardware, including stainless steel and ultra modern barn door hardware options.

DRS00 w/842 Frosted Glass



4972



Smooth 14lite w/Rain Glass



Double H-Groove



7405 w/White Lami



(V-Style Groove)

Simpson® Exterior Wood Doors



- Choose from popular wood door styles like: Arts & Crafts, Colonial, Contemporary, or our extensive collections like Nantucket®, Mastermark®, or Artist.
- Select any wood species from traditional to exotic.
- Choose from a variety of textured and obscure glass options to fit your style and personality.
- Patented Ultrablock® technology adds a water-resistant composite block in the bottom of the door stiles.
- Waterbarrier® technology, combines medium density overlay with PVC glazing for exterior French doors.

77660
w/Clear Glass in Sapelle Mahogany



49906
w/Clear Glass in Walnut



7109
w/Thermal (TDL) Glass in Fir



6841
w/Solano II Glass in Fir

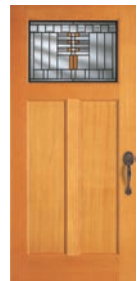

6356
w/Greenwich Glass in Fir



(6841 Solano II w/6171 Sidelight)

EXPLORE ALL DOOR OPTIONS IN THE EL & EL DOOR CATALOG OR ONLINE AT ElandELWoodProducts.com

Knotty Alder Exterior Doors



FEATURES

- Knotty Alder is a warm, inviting fine grained hardwood that adds rustic charm to any home
- Exposed knots, color variations, and mineral streaks add character and traditional appeal
- Precision-crafted with true stile & rail construction
- Stain and/or seal for a beautiful rustic finish

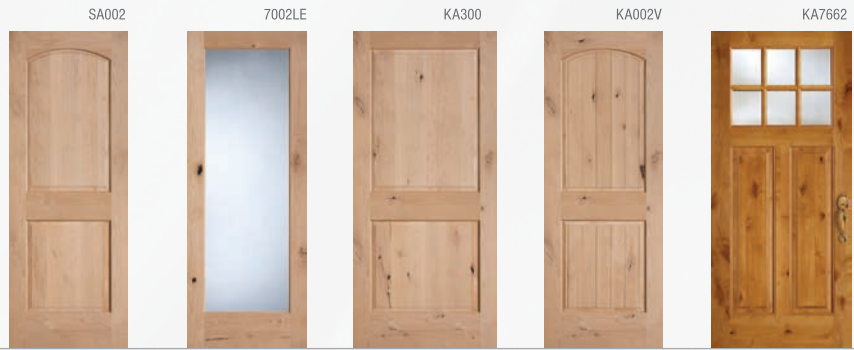

EXPLORE ALL DOOR OPTIONS IN THE EL & EL DOOR CATALOG OR ONLINE AT ELandELWoodProducts.com

Rediframe® Prefinished Steel Door Frames



FEATURES

- Interior and Exterior Applications
- Cased, Conventional or Pair-of-Door Opening Options
- UL10B and UL10C Fire-rated
- 5 Casing Material Options
- Standard Hardware Hinge & Strike Locations
- Standard and Custom Color Options Available
- Easy Installation



Part Number Index

FIND A PRODUCT FAST



feel
free
to
create



| PART NUMBER | PAGE |
|-------------|------|
|-------------|------|

Part Number Index

| | | | | | | | |
|-----------|-----|--------------|-----|---------------|----------|----------------|----------|
| 024..... | 97 | 6586..... | 181 | 1103LDF..... | 253 | 120ALD..... | 278 |
| 224..... | 97 | 6588..... | 181 | 1103MUL..... | 253 | 120BSP..... | 102 |
| 286..... | 98 | 060A..... | 8 | 1104LDF..... | 253 | 120C..... | 278 |
| 371..... | 94 | 061A..... | 8 | 1105LDF..... | 253 | 120KA..... | 278 |
| 372..... | 94 | 062A..... | 8 | 1105MUL..... | 253 | 120MH..... | 278 |
| 381..... | 99 | 063A..... | 8 | 1106LDF..... | 253 | 120MP..... | 278 |
| 387..... | 97 | 064A..... | 8 | 1107LDF..... | 253 | 120MUL..... | 185 |
| 388..... | 97 | 065A..... | 8 | 1107MUL..... | 253 | 120P..... | 278 |
| 430..... | 94 | 066A..... | 8 | 1108LDF..... | 253 | 120SP..... | 102 |
| 432..... | 94 | 067A..... | 8 | 1108MUL..... | 253 | 120VG..... | 257 |
| 433..... | 94 | 068A..... | 8 | 110BSP..... | 102 | 121FJ..... | 126 |
| 604..... | 95 | 069A..... | 8 | 110FJ..... | 126 | 121MUL..... | 185 |
| 606..... | 95 | 070A..... | 8 | 110MUL..... | 187 | 121SP..... | 102 |
| 607..... | 97 | 071A..... | 8 | 110SP..... | 102 | 122MUL..... | 189 |
| 614..... | 95 | 072A..... | 8 | 1114FI6..... | 270 | 122MUL-SC..... | 189 |
| 616..... | 97 | 100SP..... | 101 | 1114FI8..... | 270 | 122SP..... | 103 |
| 618..... | 98 | 101FJ..... | 125 | 1114FIL..... | 270 | 125-O..... | 280 |
| 619..... | 98 | 101SP..... | 101 | 1114I6..... | 182 | 125ALD..... | 280 |
| 627..... | 98 | 102-O..... | 277 | 1114I8..... | 182 | 125C..... | 280 |
| 629..... | 97 | 102FJ..... | 125 | 1114OI6..... | 332 | 125KA..... | 280 |
| 630..... | 99 | 102MUL..... | 185 | 1114PI6..... | 332 | 125MH..... | 280 |
| 634..... | 99 | 103-O..... | 277 | 1114PI8..... | 332 | 125MP..... | 280 |
| 638..... | 98 | 103BFJ..... | 126 | 1114PIL..... | 332 | 125MUL..... | 189 |
| 639..... | 98 | 103BSP..... | 102 | 111SP..... | 101 | 125P..... | 280 |
| 640..... | 99 | 103FJ..... | 126 | 112SP..... | 101 | 126-O..... | 283 |
| 642..... | 99 | 103MUL..... | 185 | 113SP..... | 101 | 126FJ..... | 130 |
| 710..... | 93 | 103SP..... | 102 | 114-O3..... | 280 | 126MUL..... | 194 |
| 711..... | 93 | 104SP..... | 101 | 114MH-3..... | 280 | 126MUL-SC..... | 194 |
| 712..... | 93 | 105SP..... | 101 | 114QWO-3..... | 280 | 126P..... | 283 |
| 713..... | 93 | 106BSP..... | 102 | 114SP..... | 105 | 127MUL..... | 189 |
| 714..... | 93 | 106SP..... | 102 | 114VG-3..... | 257 | 128-O..... | 278 |
| 715..... | 93 | 107-O..... | 277 | 114VG-5..... | 258 | 128ALD..... | 278 |
| 716..... | 93 | 107MUL..... | 185 | 114WL-3..... | 280 | 128C..... | 278 |
| 717..... | 93 | 107SP..... | 101 | 115-O..... | 278 | 128FJ..... | 127 |
| 718..... | 93 | 108-O..... | 278 | 115FJ..... | 128 | 128KA..... | 278 |
| 719..... | 93 | 108ALD..... | 278 | 115SP..... | 103 | 128MH..... | 278 |
| 720..... | 93 | 108FJ..... | 127 | 116SP..... | 103 | 128MP..... | 278 |
| 721..... | 93 | 108MH..... | 278 | 117FJ..... | 134, 141 | 128MUL..... | 187 |
| 722..... | 93 | 108MUL..... | 187 | 117SP..... | 105 | 128P..... | 278 |
| 723..... | 93 | 108P..... | 278 | 118-O4..... | 291 | 129-O..... | 280 |
| 724..... | 93 | 108SP..... | 103 | 118FJ-4..... | 136, 143 | 129ALD..... | 280 |
| 725..... | 93 | 108VG..... | 257 | 118MUL-3..... | 193, 202 | 129C..... | 280 |
| 771..... | 95 | 1098LDF..... | 253 | 118MUL-4..... | 205 | 129KA..... | 280 |
| 772..... | 95 | 1098MUL..... | 253 | 118MUL-5..... | 213 | 129MH..... | 280 |
| 773..... | 94 | 1099LDF..... | 253 | 118MUL-7..... | 217 | 129MP..... | 280 |
| 774..... | 94 | 1099MUL..... | 253 | 118P-4..... | 291 | 129MUL..... | 190 |
| 793..... | 95 | 109SP..... | 101 | 118P-5..... | 294 | 129P..... | 280 |
| 794..... | 95 | 10BB..... | 7 | 118SP-4..... | 105 | 12BB..... | 7 |
| 795..... | 95 | 10BB-O..... | 7 | 119-O..... | 280 | 12BB-O..... | 7 |
| 1400..... | 97 | 10BRS..... | 274 | 119FJ..... | 129 | 12FOS..... | 328 |
| 4126..... | 181 | 10FB..... | 347 | 119MUL..... | 189 | 12MDF-2E..... | 254, 346 |
| 4128..... | 181 | 10FB..... | 252 | 119P..... | 280 | 12MDF-BN..... | 254, 346 |
| 4186..... | 181 | 10FJ..... | 347 | 119SP..... | 104 | 12OS..... | 328 |
| 4188..... | 181 | 10FOS..... | 328 | 11BB..... | 7 | 12PB..... | 254, 345 |
| 4586..... | 181 | 10OS..... | 328 | 11BB-O..... | 7 | 130-O..... | 277 |
| 4588..... | 181 | 10RS..... | 274 | 11MDF-2E..... | 254, 346 | 130MUL..... | 185 |
| 4700..... | 347 | 1100LDF..... | 253 | 11MDF-BN..... | 254, 346 | 130P..... | 277 |
| 4750..... | 347 | 1100MUL..... | 253 | 11MDF-F..... | 254, 346 | 130SP..... | 101 |
| 4800..... | 347 | 1101LDF..... | 253 | 11PB..... | 254, 345 | 131-O..... | 278 |
| 6186..... | 181 | 1101MUL..... | 253 | 11PB-BN..... | 254, 345 | 131MUL..... | 187 |
| 6188..... | 181 | 1102LDF..... | 253 | 120-O..... | 278 | 131SP..... | 103 |



Part Number Index

| | | | | | | | |
|-----------------|----------|---------------|----------|---------------|----------|----------------|----------|
| 132ALD..... | 278 | 150MUL..... | 188 | 162BFJ..... | 127 | 176ALD..... | 281 |
| 132MUL..... | 187 | 150P..... | 278 | 162FJ..... | 127 | 176C..... | 281 |
| 132P..... | 278 | 150SP..... | 103 | 162FJ-3..... | 132 | 176FJ..... | 132 |
| 133-O..... | 284 | 152-O..... | 277 | 162MUL-2..... | 186 | 176KA..... | 281 |
| 133ALD..... | 284 | 152ALD..... | 277 | 162MUL-3..... | 191 | 176MH..... | 281 |
| 133MUL..... | 190 | 152B-O..... | 277 | 163FJ..... | 128 | 176MP..... | 281 |
| 133P..... | 284 | 152BMUL..... | 186 | 164FJ..... | 128 | 176MUL..... | 192 |
| 134MUL..... | 187 | 152C..... | 277 | 164MUL..... | 188 | 176MUL-SC..... | 192 |
| 135ALD..... | 280 | 152FJ..... | 127 | 165ALD..... | 283 | 176P..... | 281 |
| 135KA..... | 280 | 152KA..... | 277 | 165C..... | 283 | 176SP..... | 104 |
| 135MUL-2..... | 187 | 152MH..... | 277 | 165FJ..... | 129 | 176VG..... | 257 |
| 135MUL-3..... | 191 | 152MP..... | 277 | 165KA..... | 283 | 177ALD..... | 284 |
| 135MUL-3SC..... | 191 | 152MUL..... | 186 | 165MH..... | 283 | 177C..... | 284 |
| 137MUL..... | 187 | 152P..... | 277 | 165MP..... | 283 | 177KA..... | 284 |
| 138FJ..... | 134 | 152SP..... | 102 | 165MUL..... | 190 | 177MH..... | 284 |
| 138MUL..... | 188 | 152VG..... | 257 | 165P..... | 283 | 177MP..... | 284 |
| 139-O..... | 281 | 154FJ-3..... | 131 | 166ALD..... | 283 | 177MUL..... | 195 |
| 139ALD..... | 281 | 154MUL..... | 191 | 166C..... | 283 | 177P..... | 284 |
| 139C..... | 281 | 155-O..... | 283 | 166KA..... | 283 | 178ALD..... | 279 |
| 139KA..... | 281 | 155ALD..... | 283 | 166MH..... | 283 | 178C..... | 279 |
| 139MH..... | 281 | 155BSP..... | 104 | 166MP..... | 283 | 178MH..... | 279 |
| 139MP..... | 281 | 155FJ..... | 134 | 166MUL..... | 195 | 178MP..... | 279 |
| 139MUL..... | 191 | 155MUL..... | 194 | 166P..... | 283 | 178MUL..... | 187 |
| 139MUL-SC..... | 191 | 155P..... | 283 | 167-O..... | 278 | 178P..... | 279 |
| 139P..... | 280 | 155SP..... | 104 | 167ALD..... | 278 | 179-O..... | 277 |
| 139SP..... | 104 | 156-O..... | 283 | 167C..... | 278 | 179ALD..... | 277 |
| 139VG..... | 258 | 156FJ..... | 135 | 167FJ..... | 127 | 179C..... | 277 |
| 13BB..... | 7 | 156MUL..... | 194 | 167MH..... | 278 | 179M..... | 277 |
| 13BB-O..... | 7 | 156VG..... | 258 | 167MP..... | 278 | 179MP..... | 277 |
| 13MDF-F..... | 254, 346 | 157FJ..... | 128 | 167MUL..... | 187 | 179MUL..... | 195 |
| 13PB..... | 254, 345 | 157MUL..... | 188 | 167P..... | 278 | 179P..... | 277 |
| 140-O..... | 286 | 158-O..... | 282 | 168-O..... | 279 | 17PB..... | 254, 345 |
| 140MUL..... | 197 | 158ALD..... | 282 | 168MUL..... | 189 | 180MUL..... | 193 |
| 140P..... | 286 | 158C..... | 282 | 168P..... | 279 | 180P..... | 282 |
| 140VG..... | 258 | 158FJ-3..... | 135 | 169-O..... | 279 | 181MUL..... | 189 |
| 141-O..... | 277 | 158MH..... | 282 | 169B-O..... | 279 | 183BB..... | 7 |
| 141P..... | 277 | 158MP..... | 282 | 169FJ..... | 129 | 183BB-O..... | 7 |
| 141SP..... | 102 | 158MUL-2..... | 186 | 169MUL..... | 188 | 183MUL..... | 196 |
| 141VG..... | 257 | 158MUL-3..... | 193 | 169SP..... | 103 | 184-O..... | 286, 320 |
| 142SP..... | 101 | 158MUL-4..... | 198 | 16BB..... | 6 | 184MUL..... | 192 |
| 143MUL..... | 197 | 158MUL-5..... | 200 | 16BB-O..... | 6 | 185ALD..... | 284 |
| 143SP..... | 102 | 158P..... | 282 | 16FJ..... | 346 | 185BB..... | 6 |
| 145MUL..... | 199, 253 | 159FJ..... | 128 | 16MDF-BN..... | 346 | 185BB-O..... | 6 |
| 145SP..... | 103 | 159MUL..... | 188 | 16MDF-F..... | 254, 346 | 185MUL..... | 199 |
| 146MUL-2..... | 185 | 159P..... | 279 | 16PB..... | 254, 345 | 186-O..... | 282 |
| 146MUL-3..... | 193 | 15BB..... | 6 | 16PB-BN..... | 254, 345 | 186ALD..... | 282 |
| 146MUL-4..... | 198 | 15BB-O..... | 6 | 170FJ..... | 132 | 186BB..... | 6 |
| 147FJ..... | 129 | 15FB..... | 254, 346 | 170MUL..... | 192 | 186BB-O..... | 6 |
| 147MUL..... | 194 | 15FJ..... | 346 | 172MUL-2..... | 186 | 186C..... | 282 |
| 148MUL..... | 198 | 160-O..... | 281 | 172MUL-3..... | 195 | 186MH..... | 282 |
| 149MUL-2..... | 186 | 160ALD..... | 281 | 172VG-3..... | 257 | 186MP..... | 282 |
| 149MUL-3..... | 194 | 160C..... | 281 | 173FJ..... | 136 | 186MUL..... | 192 |
| 149MUL-4..... | 198 | 160FJ..... | 131 | 173MUL..... | 195 | 186P..... | 281 |
| 14BB..... | 6 | 160KA..... | 281 | 174MUL..... | 196 | 186SP..... | 105 |
| 14BB-O..... | 6 | 160MH..... | 281 | 174P..... | 285 | 187BB..... | 7 |
| 150-O..... | 278 | 160MP..... | 281 | 175-O..... | 284 | 187BB-O..... | 7 |
| 150ALD..... | 278 | 160MUL..... | 190 | 175C..... | 284 | 187MUL..... | 199 |
| 150C..... | 278 | 160P..... | 281 | 175MH..... | 284 | 189MUL..... | 196 |
| 150FJ..... | 128 | 161-O..... | 281 | 175MP..... | 284 | 18BB..... | 6 |
| 150MH..... | 278 | 161FJ..... | 132 | 175MUL..... | 196 | 18PB..... | 345 |
| 150MP..... | 278 | 161MUL..... | 191 | 176-O..... | 281 | 18PB..... | 254 |



Part Number Index

| | | | | | | | |
|---------------|-----|--------------|----------|-----------------|----------|---------------|-----|
| 190ALD..... | 286 | 2003LDF..... | 251 | 307-O..... | 289 | 321SP-3..... | 110 |
| 190BB..... | 7 | 2003SP..... | 122 | 307BSP..... | 109 | 323-O..... | 293 |
| 190BB-O..... | 7 | 2005LDF..... | 251 | 307FJ..... | 141 | 323C..... | 293 |
| 190KA..... | 286 | 2005MUL..... | 251 | 307MUL..... | 202 | 323FJ..... | 146 |
| 190MUL..... | 199 | 2007LDF..... | 251 | 307SP..... | 109 | 323MH..... | 293 |
| 190P..... | 286 | 2008LDF..... | 251 | 30MDF-F..... | 254, 346 | 323MP..... | 293 |
| 190SP..... | 101 | 2009LDF..... | 251 | 310-O..... | 288 | 323MUL..... | 208 |
| 191BB..... | 7 | 200SP..... | 106 | 310BFJ..... | 138 | 323P..... | 293 |
| 191BB-O..... | 7 | 201C..... | 288 | 310BMUL..... | 201 | 324-O..... | 290 |
| 191MUL..... | 193 | 201LDF..... | 200 | 310FJ..... | 138 | 324ALD..... | 290 |
| 191P..... | 286 | 201MUL..... | 200 | 310MUL..... | 201 | 324C..... | 290 |
| 192BB..... | 6 | 201P..... | 288 | 311-O..... | 289 | 324FJ..... | 142 |
| 192BB-O..... | 6 | 201SP..... | 106 | 311ALD-3..... | 289 | 324MH..... | 290 |
| 192MUL..... | 190 | 201VG..... | 259 | 311BMUL..... | 203 | 324MP..... | 290 |
| 193BB..... | 6 | 202MUL..... | 200 | 311FJ..... | 141 | 324MUL..... | 203 |
| 193BB-O..... | 6 | 202SP..... | 106 | 311LDF-3N..... | 201 | 324P..... | 290 |
| 193MUL..... | 196 | 203MUL..... | 200 | 311LDF-4..... | 205 | 325ALD..... | 292 |
| 194BB..... | 7 | 203SP..... | 106 | 311MH-3..... | 289 | 325C..... | 292 |
| 194BB-O..... | 7 | 204MUL..... | 200 | 311MUL..... | 203 | 325FJ..... | 144 |
| 194BBALD..... | 7 | 204SP..... | 106 | 311MUL-4..... | 205 | 325MH..... | 292 |
| 194BBMDF..... | 7 | 205SP..... | 106 | 311P-3..... | 289 | 325MP..... | 292 |
| 194BBMP..... | 7 | 206SP..... | 106 | 311P-4..... | 291 | 325MUL..... | 206 |
| 194MUL..... | 186 | 207SP..... | 106 | 313MUL..... | 204 | 325P..... | 292 |
| 195BB..... | 7 | 208SP..... | 106 | 314-O4..... | 290 | 326-O..... | 291 |
| 195BB-O..... | 7 | 209VG..... | 259 | 314ALD-4..... | 290 | 326FJ..... | 144 |
| 195BBALD..... | 7 | 210BSP..... | 106 | 314MUL-3..... | 201 | 326MUL..... | 205 |
| 195BBMDF..... | 7 | 210MUL..... | 200 | 314MUL-3SC..... | 201 | 326P..... | 291 |
| 195BBMP..... | 7 | 210SP..... | 106 | 314MUL-4..... | 205 | 327MUL-4..... | 206 |
| 195MUL..... | 186 | 212SP..... | 106 | 314MUL-5..... | 209 | 327MUL-5..... | 210 |
| 196BB..... | 7 | 213SP..... | 106 | 314MUL-5SC..... | 209 | 328FJ-5..... | 148 |
| 196BB-O..... | 7 | 214SP..... | 106 | 314MUL-7..... | 218 | 328MUL-5..... | 210 |
| 196BBALD..... | 7 | 216SP..... | 106 | 314P-4..... | 290 | 328MUL-6..... | 216 |
| 196BBMDF..... | 7 | 217SP..... | 106 | 314SP-3..... | 109 | 329ALD..... | 290 |
| 196BBMP..... | 7 | 218SP..... | 106 | 314SP-5..... | 111 | 329C..... | 290 |
| 196MUL..... | 186 | 219SP..... | 106 | 314VG-3..... | 260 | 329KA..... | 290 |
| 197BB..... | 7 | 21BB..... | 7 | 316-O..... | 291 | 329MH..... | 290 |
| 197BB-O..... | 7 | 21BB-O..... | 7 | 316FJ..... | 143 | 329MP..... | 290 |
| 197BBALD..... | 7 | 22BB..... | 7 | 317FJ..... | 147 | 329MUL..... | 204 |
| 197BBMFD..... | 7 | 22BB-O..... | 7 | 317MUL..... | 209 | 330BMUL..... | 208 |
| 197BBMP..... | 7 | 23BB..... | 7 | 318-O4..... | 290 | 330BP..... | 293 |
| 197MUL..... | 188 | 23BB-O..... | 7 | 318-O5..... | 293 | 330MUL..... | 208 |
| 198BB..... | 7 | 24PB-BN..... | 254, 345 | 318ALD-4..... | 290 | 331MUL..... | 222 |
| 198BB-O..... | 7 | 2BBMDF..... | 6 | 318BFJ..... | 148 | 332MUL..... | 215 |
| 198BBALD..... | 7 | 300A-O..... | 288 | 318BMUL..... | 209 | 332P..... | 296 |
| 198BBMDF..... | 7 | 300AFJ..... | 138 | 318C-4..... | 290 | 333MUL..... | 218 |
| 198BBMP..... | 7 | 300ASP..... | 107 | 318FJ-4..... | 143 | 333P-4..... | 292 |
| 198MUL..... | 188 | 300B-O..... | 288 | 318MH-4..... | 290 | 333P-7..... | 297 |
| 199ALD..... | 285 | 300BALD..... | 288 | 318MP-4..... | 290 | 334BMUL..... | 217 |
| 199KA..... | 285 | 300BC..... | 288 | 318MUL-4..... | 204 | 334MUL..... | 217 |
| 1BBMDF..... | 6 | 300BMH..... | 288 | 318MUL-5..... | 210 | 335MUL..... | 203 |
| 1x4BS..... | 95 | 300BMP..... | 288 | 318P-4..... | 290 | 338-O3..... | 289 |
| 1x6NGS..... | 95 | 300BP..... | 288 | 318P-5..... | 293 | 338-O4..... | 292 |
| 2000FJ..... | 179 | 300BSP..... | 107 | 318SP-5..... | 111 | 338ALD-4..... | 292 |
| 2000LDF..... | 251 | 300BVG..... | 259 | 319FJ..... | 139 | 338C-4..... | 292 |
| 2000SP..... | 122 | 301FJ..... | 138, 175 | 319MUL..... | 201 | 338MH-4..... | 292 |
| 2001FJ..... | 179 | 304FJ..... | 138 | 320MUL..... | 201 | 338MH-5..... | 295 |
| 2001LDF..... | 251 | 304MUL..... | 201 | 321FJ-2..... | 139 | 338MP-4..... | 292 |
| 2001SP..... | 122 | 305FJ..... | 138 | 321FJ-3..... | 142 | 338MP-5..... | 295 |
| 2002LDF..... | 251 | 306-O..... | 288 | 321FJ-4..... | 145 | 338MUL-3..... | 203 |
| 2002SP..... | 122 | 306BSP..... | 107 | 321MUL-3..... | 203 | 338MUL-4..... | 206 |
| 2003ALD..... | 321 | 306SP..... | 107 | 321MUL-4..... | 204 | 338MUL-5..... | 211 |



Part Number Index

| | | | | | | | |
|----------------|-----|----------------|-----|---------------|-----|---------------|-----|
| 338MUL-9..... | 224 | 365MUL..... | 213 | 3916FI8..... | 270 | 410MP-6..... | 306 |
| 338P-3..... | 289 | 365P-5..... | 295 | 3916FIL..... | 270 | 410MP-8..... | 312 |
| 338P-4..... | 292 | 365P-7..... | 298 | 3916I6..... | 182 | 410MUL-4..... | 229 |
| 338P-7..... | 298 | 366MUL..... | 202 | 3916I6K2..... | 182 | 410MUL-5..... | 232 |
| 339FJ..... | 140 | 367FJ..... | 142 | 3916I8..... | 182 | 410MUL-6..... | 236 |
| 339MUL..... | 203 | 368MUL..... | 213 | 3916I8K2..... | 182 | 410MUL-8..... | 245 |
| 340ALD..... | 298 | 36BB..... | 6 | 3916IL..... | 182 | 410P-6..... | 306 |
| 340MUL..... | 218 | 36BBALD..... | 6 | 3916KAI6..... | 332 | 410P-8..... | 312 |
| 340P..... | 298 | 36BBC..... | 6 | 3916KAI8..... | 332 | 411MUL-4..... | 231 |
| 341MUL..... | 211 | 36BBMDF..... | 6 | 3916KAIL..... | 332 | 411MUL-5..... | 233 |
| 342ALD-6..... | 297 | 36BBMP..... | 6 | 392MUL-4..... | 207 | 411MUL-6..... | 238 |
| 342C-6..... | 297 | 36BBP..... | 6 | 392MUL-5..... | 215 | 412FGE6..... | 270 |
| 342KA-6..... | 297 | 372MUL-5..... | 214 | 39BB..... | 6 | 412FGE8..... | 270 |
| 342MH-6..... | 297 | 372MUL-7..... | 221 | 39BBALD..... | 6 | 412FGL..... | 270 |
| 342MP-6..... | 297 | 375MUL..... | 216 | 39BBC..... | 6 | 412L..... | 181 |
| 342MUL-6..... | 215 | 375VG-7..... | 261 | 39BBMDF..... | 6 | 412MUL..... | 230 |
| 342MUL-7..... | 218 | 379MUL..... | 221 | 39BBMP..... | 6 | 412O6..... | 332 |
| 342MUL-8..... | 222 | 37BB..... | 6 | 39BBP..... | 6 | 412O8..... | 332 |
| 342P-6..... | 297 | 37BBALD..... | 6 | 3BB-O..... | 6 | 412OL..... | 332 |
| 343MUL..... | 219 | 37BBC..... | 6 | 3BBMDF..... | 6 | 412SD6..... | 182 |
| 345MUL..... | 219 | 37BBMDF..... | 6 | 3CL..... | 347 | 412SD8..... | 182 |
| 349MUL-4..... | 207 | 37BBMP..... | 6 | 400SP..... | 112 | 412SDL..... | 182 |
| 349MUL-5..... | 211 | 37BBP..... | 6 | 401SP-1..... | 112 | 412W6..... | 181 |
| 349MUL-7..... | 219 | 380MUL..... | 222 | 402MUL..... | 226 | 412W8..... | 181 |
| 350MUL..... | 211 | 381K..... | 99 | 404MUL..... | 226 | 412WL..... | 181 |
| 351MUL..... | 202 | 381MUL..... | 223 | 405-O..... | 300 | 412WOL..... | 332 |
| 352MUL..... | 212 | 382MUL..... | 223 | 405ALD..... | 300 | 414LDF..... | 234 |
| 352MUL-SC..... | 212 | 385-O..... | 297 | 405B-O..... | 300 | 414MUL..... | 234 |
| 353MUL..... | 220 | 385ALD..... | 297 | 405BP..... | 300 | 414SP..... | 114 |
| 354MUL..... | 214 | 385C..... | 297 | 405BSP..... | 112 | 415MUL..... | 242 |
| 355MUL..... | 212 | 385MH..... | 297 | 405C..... | 300 | 416MUL..... | 239 |
| 358MUL..... | 220 | 385MP..... | 297 | 405KA..... | 300 | 416P..... | 308 |
| 359MUL..... | 214 | 385MUL..... | 216 | 405MH..... | 300 | 417ALD..... | 311 |
| 359P..... | 294 | 385P..... | 297 | 405MP..... | 300 | 417B-O..... | 311 |
| 35BB..... | 6 | 387-O4..... | 292 | 405MUL..... | 226 | 417BALD..... | 311 |
| 35BBALD..... | 6 | 387ALD-4..... | 292 | 405P..... | 300 | 417BC..... | 311 |
| 35BBC..... | 6 | 387C-4..... | 292 | 405SP..... | 112 | 417BMH..... | 311 |
| 35BBMDF..... | 6 | 387KA-5..... | 295 | 406MUL..... | 228 | 417BMP..... | 311 |
| 35BBMP..... | 6 | 387MH-4..... | 292 | 406P..... | 301 | 417MUL..... | 243 |
| 35BBP..... | 6 | 387MP-4..... | 292 | 406SP..... | 113 | 417P..... | 311 |
| 360MUL..... | 220 | 387MUL..... | 221 | 407MUL..... | 229 | 418C6..... | 332 |
| 361-O5..... | 294 | 387MUL-3..... | 203 | 408FJ..... | 164 | 418C8..... | 332 |
| 361-O7..... | 298 | 387MUL-4..... | 207 | 408MUL-4..... | 231 | 418CL..... | 332 |
| 361ALD-5..... | 294 | 387MUL-5..... | 215 | 408MUL-6..... | 236 | 418FGE6..... | 270 |
| 361ALD-7..... | 298 | 387P-4..... | 292 | 409-O..... | 302 | 418FGE8..... | 270 |
| 361C-5..... | 294 | 387SP-5..... | 111 | 409MUL..... | 230 | 418FGL..... | 270 |
| 361C-7..... | 298 | 389MUL..... | 217 | 40BB..... | 6 | 418L..... | 181 |
| 361KA-5..... | 294 | 38BB..... | 6 | 40BB-O..... | 6 | 418M6..... | 332 |
| 361MH-5..... | 294 | 38BB-O..... | 6 | 40BBALD..... | 6 | 418M8..... | 332 |
| 361MH-7..... | 298 | 38BBALD..... | 6 | 40BBC..... | 6 | 418ML..... | 332 |
| 361MP-5..... | 294 | 38BBC..... | 6 | 40BBMDF..... | 6 | 418O6..... | 332 |
| 361MP-7..... | 298 | 38BBMDF..... | 6 | 40BBMP..... | 6 | 418O8..... | 332 |
| 361MUL-3..... | 202 | 38BBMP..... | 6 | 40BBP..... | 6 | 418OL..... | 332 |
| 361MUL-4..... | 207 | 38BBP..... | 6 | 410-O6..... | 306 | 418P6..... | 332 |
| 361MUL-5..... | 212 | 390MUL..... | 208 | 410ALD-6..... | 306 | 418P8..... | 332 |
| 361MUL-7..... | 221 | 3916ALDI6..... | 332 | 410C-6..... | 306 | 418PL..... | 332 |
| 361MUL-9..... | 224 | 3916ALDI8..... | 332 | 410C-8..... | 312 | 418SD6..... | 182 |
| 361P-5..... | 294 | 3916ALDIL..... | 332 | 410FJ-6..... | 164 | 418SD8..... | 182 |
| 361P-7..... | 298 | 3916CI6..... | 332 | 410KA-6..... | 306 | 418SDL..... | 182 |
| 362MUL-4..... | 205 | 3916CI8..... | 332 | 410MH-6..... | 306 | 418SP..... | 112 |
| 362MUL-5..... | 213 | 3916FI6..... | 270 | 410MH-8..... | 312 | 418SP6..... | 124 |



Part Number Index

| | | | | | | | |
|---------------|-----|---------------|-----|---------------|-----|----------------|-----|
| 418SP8..... | 124 | 427ALD..... | 308 | 436MP..... | 299 | 458P8..... | 332 |
| 418VGE6..... | 270 | 427C..... | 308 | 436MUL..... | 226 | 458PL..... | 332 |
| 418VGE8..... | 270 | 427MH..... | 308 | 436P..... | 299 | 458SA6..... | 332 |
| 418VGL..... | 270 | 427MP..... | 308 | 436SP..... | 112 | 458SA8..... | 332 |
| 418W6..... | 181 | 427MUL..... | 240 | 437MUL..... | 241 | 458SP6..... | 124 |
| 418W8..... | 181 | 427P..... | 308 | 437P..... | 312 | 458SP8..... | 124 |
| 418WC6..... | 332 | 428MUL..... | 244 | 438MUL..... | 225 | 458VGE6..... | 270 |
| 418WC8..... | 332 | 429MUL..... | 248 | 439MUL..... | 225 | 458VGE8..... | 270 |
| 418WCL..... | 332 | 42BB..... | 6 | 43BB..... | 6 | 458VGL..... | 270 |
| 418WFGE6..... | 270 | 42BB-O..... | 6 | 43BB-O..... | 6 | 458W6..... | 181 |
| 418WFGE8..... | 270 | 42BBALD..... | 6 | 43BBALD..... | 6 | 458W8..... | 181 |
| 418WFGL..... | 270 | 42BBC..... | 6 | 43BBC..... | 6 | 458WC6..... | 332 |
| 418WL..... | 181 | 42BBMDF..... | 6 | 43BBMDF..... | 6 | 458WC8..... | 332 |
| 418WM6..... | 332 | 42BBMP..... | 6 | 43BBMP..... | 6 | 458WCL..... | 332 |
| 418WM8..... | 332 | 42BBP..... | 6 | 43BBP..... | 6 | 458WFGE6..... | 270 |
| 418WML..... | 332 | 432MUL..... | 245 | 440MUL..... | 225 | 458WFGE8..... | 270 |
| 418WO6..... | 332 | 433MUL..... | 241 | 441MUL..... | 227 | 458WKA6..... | 332 |
| 418WO8..... | 332 | 434ALDI6..... | 332 | 441P..... | 300 | 458WKA8..... | 332 |
| 418WOL..... | 332 | 434ALDI8..... | 332 | 442MUL..... | 232 | 458WL..... | 181 |
| 418WP6..... | 332 | 434ALDIL..... | 332 | 442P..... | 302 | 458WM6..... | 332 |
| 418WP8..... | 332 | 434ALDIL..... | 332 | 443MUL..... | 240 | 458WM8..... | 332 |
| 418WPL..... | 332 | 434CI6..... | 332 | 443P..... | 307 | 458WML..... | 332 |
| 418WSP6..... | 124 | 434CI8..... | 332 | 444MUL-3..... | 227 | 458WO6..... | 332 |
| 418WSP8..... | 124 | 434CIL..... | 332 | 444MUL-4..... | 231 | 458WO8..... | 332 |
| 418WVGE6..... | 270 | 434EL..... | 181 | 444MUL-5..... | 235 | 458WOL..... | 332 |
| 418WVGE8..... | 270 | 434FGE6..... | 270 | 444MUL-7..... | 243 | 458WP6..... | 332 |
| 418WVGL..... | 270 | 434FGE8..... | 270 | 446MUL..... | 228 | 458WP8..... | 332 |
| 419MUL..... | 225 | 434FGL..... | 270 | 447MUL..... | 240 | 458WPL..... | 332 |
| 41BB..... | 6 | 434FI6..... | 270 | 448MUL..... | 238 | 458WSA6..... | 332 |
| 41BB-O..... | 6 | 434FI8..... | 270 | 449MUL..... | 247 | 458WSA8..... | 332 |
| 41BBALD..... | 6 | 434FIL..... | 270 | 44BB..... | 6 | 458WSP6..... | 124 |
| 41BBC..... | 6 | 434I6..... | 182 | 44BB-O..... | 6 | 458WSP8..... | 124 |
| 41BBMDF..... | 6 | 434I8..... | 182 | 44BBALD..... | 6 | 458WVGE6..... | 270 |
| 41BBMP..... | 6 | 434I8..... | 182 | 44BBC..... | 6 | 458WVGE8..... | 270 |
| 41BBP..... | 6 | 434I8..... | 182 | 44BBMDF..... | 6 | 458WVGL..... | 270 |
| 420MUL..... | 226 | 434I8..... | 182 | 44BBMP..... | 6 | 460MUL-2..... | 226 |
| 421MUL..... | 227 | 434KAI6..... | 332 | 44BBP..... | 6 | 460MUL-4..... | 230 |
| 421P..... | 300 | 434KAI8..... | 332 | 451MUL..... | 228 | 460MUL-5..... | 233 |
| 422MUL..... | 230 | 434KAIL..... | 332 | 453MUL..... | 236 | 462MUL-2..... | 226 |
| 423ALD..... | 303 | 434MHI8..... | 332 | 454MUL..... | 246 | 462MUL-4..... | 231 |
| 423BMUL..... | 232 | 434MI6..... | 255 | 455LDF..... | 233 | 462MUL-6..... | 237 |
| 423C..... | 303 | 434MI8..... | 255 | 456P..... | 309 | 462VG..... | 263 |
| 423KA..... | 303 | 434MIL..... | 255 | 458ALDI6..... | 332 | 465LDF-5..... | 233 |
| 423MH..... | 303 | 434MUL..... | 229 | 458ALDI8..... | 332 | 465LDF-7..... | 244 |
| 423MP..... | 303 | 434O16..... | 332 | 458ALDIL..... | 332 | 467MUL..... | 229 |
| 423MUL..... | 232 | 434O18..... | 332 | 458C6..... | 332 | 469MUL..... | 232 |
| 423P..... | 303 | 434OIL..... | 332 | 458C8..... | 332 | 478ALDI6..... | 332 |
| 424-O6..... | 309 | 434PI6..... | 332 | 458CL..... | 332 | 478ALDI8..... | 332 |
| 424ALD-6..... | 309 | 434PI8..... | 332 | 458DFGL..... | 270 | 478ALDIL..... | 332 |
| 424C-6..... | 309 | 434PIL..... | 332 | 458DR6..... | 180 | 478I6..... | 182 |
| 424KA-6..... | 309 | 434PV16..... | 124 | 458DRL..... | 180 | 478I8..... | 182 |
| 424LDF-7..... | 242 | 434SD6..... | 182 | 458KA6..... | 332 | 478IL..... | 182 |
| 424MH-6..... | 309 | 434SD8..... | 182 | 458KA8..... | 332 | 49-O..... | 329 |
| 424MP-6..... | 309 | 434SDL..... | 182 | 458L..... | 181 | 4916ALDI6..... | 332 |
| 424MUL-6..... | 239 | 434SPI6..... | 124 | 458M6..... | 332 | 4916ALDI8..... | 332 |
| 424MUL-7..... | 242 | 434SPI8..... | 124 | 458M8..... | 332 | 4916ALDIL..... | 332 |
| 424P-6..... | 309 | 434W6..... | 181 | 458ML..... | 332 | 4916CI6..... | 332 |
| 425MUL-3..... | 228 | 434W8..... | 181 | 458O6..... | 332 | 4916CI8..... | 332 |
| 425MUL-5..... | 235 | 434WL..... | 181 | 458O8..... | 332 | 4916CIL..... | 332 |
| 426MUL..... | 227 | 435MUL..... | 237 | 458OL..... | 332 | 4916FI6..... | 270 |
| 427-O..... | 308 | 436-O..... | 299 | 458P6..... | 332 | 4916FI8..... | 270 |
| | | 436ALD..... | 299 | | | | |
| | | 436C..... | 299 | | | | |
| | | 436MH..... | 299 | | | | |



Part Number Index

| | | | | | | | |
|---------------|-----|--------------|-----|---------------|-----|--------------|----------|
| 4916FIL..... | 270 | 514FGE8..... | 270 | 514WP6..... | 332 | 593ALD..... | 314 |
| 4916I6..... | 182 | 514FGL..... | 270 | 514WP8..... | 332 | 593C..... | 314 |
| 4916I8..... | 182 | 514FI6..... | 270 | 514WPL..... | 332 | 593MH..... | 314 |
| 4916IL..... | 182 | 514FI8..... | 270 | 514WSA6..... | 332 | 593MP..... | 314 |
| 4916KAI6..... | 332 | 514FIL..... | 270 | 514WSA8..... | 332 | 593P..... | 314 |
| 4916KAI8..... | 332 | 514I6..... | 182 | 514WSP6..... | 124 | 593SP..... | 117 |
| 4916KAIL..... | 332 | 514I8..... | 182 | 514WSP8..... | 124 | 594-O..... | 314 |
| 4916MI6..... | 255 | 514IL..... | 182 | 514WVGE6..... | 270 | 594ALD..... | 314 |
| 4916MI8..... | 255 | 514KAE6..... | 332 | 514WVGE8..... | 270 | 594C..... | 314 |
| 4916MIL..... | 255 | 514KAE8..... | 332 | 514WVGL..... | 270 | 594MH..... | 314 |
| 4916OI6..... | 332 | 514KAI6..... | 332 | 520SP..... | 116 | 594MP..... | 314 |
| 4916OI8..... | 332 | 514KAI8..... | 332 | 521-O..... | 314 | 594P..... | 314 |
| 4916OIL..... | 332 | 514KAIL..... | 332 | 521ALD..... | 314 | 594SP..... | 117 |
| 4916PI6..... | 332 | 514ME6..... | 332 | 521C..... | 314 | 597SP..... | 117 |
| 4916PI8..... | 332 | 514ME8..... | 332 | 521MH..... | 314 | 598P..... | 314 |
| 4916PIL..... | 332 | 514MEL..... | 332 | 521MP..... | 314 | 599VG..... | 264 |
| 4916PVI6..... | 124 | 514MHI8..... | 332 | 521P..... | 314 | 5ALDS..... | 328 |
| 4916PVI8..... | 124 | 514MI6..... | 255 | 521SP..... | 116 | 5BBMDF..... | 6 |
| 4916SPI6..... | 124 | 514MI8..... | 255 | 522SP..... | 116 | 5CS..... | 328 |
| 4916SPI8..... | 124 | 514MIL..... | 255 | 523-O..... | 314 | 5MHS..... | 328 |
| 4BBMDF..... | 6 | 514OE6..... | 332 | 523ALD..... | 314 | 5WLS..... | 328 |
| 4CL..... | 347 | 514OE8..... | 332 | 523C..... | 314 | 600-O..... | 315 |
| 50-O..... | 329 | 514OEL..... | 332 | 523MH..... | 314 | 600SP..... | 119 |
| 500SP..... | 116 | 514OI6..... | 332 | 523MP..... | 314 | 601-O..... | 315 |
| 501SP..... | 116 | 514OI8..... | 332 | 523P..... | 314 | 601SP..... | 119 |
| 502-O..... | 314 | 514OIL..... | 332 | 523R..... | 271 | 602-O..... | 315 |
| 502C..... | 314 | 514PE6..... | 332 | 523SP..... | 116 | 602ALD..... | 315 |
| 502MH..... | 314 | 514PE8..... | 332 | 523VG..... | 264 | 602SP..... | 119 |
| 502MP..... | 314 | 514PEL..... | 332 | 524SP..... | 116 | 605-O..... | 315 |
| 502P..... | 314 | 514PI6..... | 332 | 525BSP..... | 116 | 605ALD..... | 315 |
| 502SP..... | 116 | 514PI8..... | 332 | 525SP..... | 116 | 605SP..... | 119 |
| 503SP..... | 116 | 514PIL..... | 332 | 526SP..... | 116 | 606-O..... | 315 |
| 504-O..... | 314 | 514PV16..... | 124 | 527BSP..... | 116 | 606SP..... | 119 |
| 504ALD..... | 314 | 514SAE6..... | 332 | 527SP..... | 116 | 608-O..... | 315 |
| 504C..... | 314 | 514SAE8..... | 332 | 528SP..... | 116 | 611P..... | 318 |
| 504MH..... | 314 | 514SD6..... | 182 | 570SP..... | 116 | 612-O..... | 315 |
| 504MP..... | 314 | 514SD8..... | 182 | 571SP..... | 116 | 612ALD..... | 315 |
| 504P..... | 314 | 514SDL..... | 182 | 572-O..... | 314 | 612ASP..... | 121 |
| 504R..... | 271 | 514SPE6..... | 124 | 572C..... | 314 | 612AVG..... | 269 |
| 504SP..... | 116 | 514SPE8..... | 124 | 572MH..... | 314 | 612BALD..... | 323 |
| 504VG..... | 264 | 514SPI6..... | 124 | 572MP..... | 314 | 612BC..... | 323 |
| 505SP..... | 116 | 514SPI8..... | 124 | 572P..... | 314 | 612BMH..... | 323 |
| 50S..... | 328 | 514VGE6..... | 270 | 572SP..... | 116 | 612BSP..... | 121 |
| 512I6..... | 182 | 514VGE8..... | 270 | 573SP..... | 116 | 612BVG..... | 269 |
| 512I8..... | 182 | 514VGL..... | 270 | 574SP..... | 116 | 612C..... | 315 |
| 512W6..... | 181 | 514W8..... | 181 | 575P..... | 314 | 612MH..... | 315 |
| 512W8..... | 181 | 514WC6..... | 332 | 576P..... | 314 | 612MP..... | 315 |
| 514ALDI6..... | 332 | 514WC8..... | 332 | 580-O..... | 314 | 612P..... | 315 |
| 514ALDI8..... | 332 | 514WCL..... | 332 | 580MP..... | 314 | 613-O..... | 316 |
| 514ALDIL..... | 332 | 514WFG6..... | 270 | 581-O..... | 314 | 613P..... | 316 |
| 514CE6..... | 332 | 514WFG6..... | 270 | 581MP..... | 314 | 613SP..... | 119 |
| 514CE8..... | 332 | 514WFG8..... | 270 | 582-O..... | 314 | 614-O..... | 316 |
| 514CEL..... | 332 | 514WFL..... | 270 | 582MP..... | 314 | 614ALD..... | 316 |
| 514CI6..... | 332 | 514WKA6..... | 332 | 583-O..... | 314 | 614C..... | 316 |
| 514CI8..... | 332 | 514WKA8..... | 332 | 583MP..... | 314 | 614MH..... | 316 |
| 514CIL..... | 332 | 514WL..... | 181 | 590SP..... | 117 | 614MP..... | 316 |
| 514DR6..... | 180 | 514WM6..... | 332 | 591-O..... | 314 | 614P..... | 316 |
| 514DRL..... | 180 | 514WM8..... | 332 | 591P..... | 314 | 614SP..... | 107, 119 |
| 514EL..... | 181 | 514WML..... | 332 | 591SP..... | 117 | 615P..... | 317 |
| 514EW6..... | 181 | 514WO6..... | 332 | 592SP..... | 117 | 615SP..... | 107, 119 |
| 514FGE6..... | 270 | 514WO8..... | 332 | 593-O..... | 314 | 616P..... | 316 |
| | | 514WOL..... | 332 | | | | |



Part Number Index

| | | | | | | | |
|---------------|-----|---------------|-----|--------------|-----|---------------|-----|
| 617P..... | 317 | 632P..... | 316 | 660MUL..... | 250 | 712I8..... | 182 |
| 618FGE6..... | 270 | 635-O..... | 315 | 660P..... | 322 | 712SP..... | 121 |
| 618FGE8..... | 270 | 635P..... | 315 | 660SP..... | 118 | 712W6..... | 181 |
| 618FGL..... | 270 | 638..... | 97 | 660VG..... | 265 | 712W8..... | 181 |
| 618L..... | 181 | 646-O..... | 322 | 661-O..... | 322 | 712WL..... | 181 |
| 618SD6..... | 182 | 646ALD..... | 322 | 661ALD..... | 322 | 713-O..... | 331 |
| 618SD8..... | 182 | 646C..... | 322 | 661C..... | 322 | 713LDF..... | 253 |
| 618SDL..... | 182 | 646MUL..... | 250 | 661MH..... | 322 | 713MH..... | 331 |
| 618W6..... | 181 | 646P..... | 322 | 661P..... | 322 | 713MUL..... | 253 |
| 618W8..... | 181 | 646SP..... | 118 | 661VG..... | 265 | 713P..... | 331 |
| 618WFGE6..... | 270 | 646VG..... | 265 | 662-O..... | 322 | 713R..... | 271 |
| 618WFGE8..... | 270 | 647MUL..... | 249 | 662ALD..... | 322 | 713SP..... | 121 |
| 618WFGL..... | 270 | 648-O..... | 319 | 662C..... | 322 | 713VG..... | 266 |
| 618WL..... | 181 | 648MUL..... | 249 | 662SP..... | 118 | 714-O..... | 331 |
| 619P..... | 318 | 648P..... | 319 | 662VG..... | 265 | 714ALDI6..... | 332 |
| 620-O..... | 317 | 649MUL..... | 249 | 663-O..... | 322 | 714ALDI8..... | 332 |
| 620ALD..... | 317 | 651-O..... | 319 | 663ALD..... | 322 | 714ALDIL..... | 332 |
| 620C..... | 317 | 651MUL..... | 249 | 663B-O..... | 322 | 714C..... | 331 |
| 620MH..... | 317 | 653-O..... | 319 | 663BALD..... | 322 | 714CE6..... | 332 |
| 620MP..... | 317 | 653C..... | 319 | 663BMH..... | 322 | 714CE8..... | 332 |
| 620P..... | 317 | 653MH..... | 319 | 663BP..... | 322 | 714CEL..... | 332 |
| 620SP..... | 118 | 653MP..... | 319 | 663BVG..... | 265 | 714CI6..... | 332 |
| 620VG..... | 264 | 653MUL..... | 249 | 663C..... | 322 | 714CI8..... | 332 |
| 621-O..... | 317 | 653P..... | 319 | 663MH..... | 322 | 714CIL..... | 332 |
| 621ALD..... | 317 | 654P..... | 320 | 663P..... | 322 | 714EL..... | 181 |
| 621C..... | 317 | 655-O..... | 319 | 663VG..... | 265 | 714EW6..... | 181 |
| 621MH..... | 317 | 655MUL..... | 249 | 664VG..... | 265 | 714FGE6..... | 270 |
| 621MP..... | 317 | 655P..... | 319 | 667MH..... | 322 | 714FGE8..... | 270 |
| 621P..... | 317 | 656MUL..... | 249 | 667P..... | 322 | 714FGL..... | 270 |
| 622ALD..... | 318 | 656P..... | 320 | 667QWO..... | 322 | 714FI6..... | 270 |
| 622P..... | 318 | 658-O..... | 319 | 667VG..... | 265 | 714FI8..... | 270 |
| 623P..... | 316 | 658C6..... | 332 | 667WL..... | 322 | 714FIL..... | 270 |
| 623SP..... | 118 | 658C8..... | 332 | 680P..... | 314 | 714I6..... | 182 |
| 623VG..... | 264 | 658DR6..... | 180 | 691I6..... | 182 | 714I8..... | 182 |
| 624-O..... | 315 | 658DRL..... | 180 | 691I8..... | 182 | 714IL..... | 182 |
| 624SP..... | 118 | 658FGE6..... | 270 | 691IL..... | 182 | 714KAE6..... | 332 |
| 625P..... | 316 | 658FGE8..... | 270 | 691MI6..... | 255 | 714KAE8..... | 332 |
| 625SP..... | 118 | 658FGL..... | 270 | 691MI8..... | 255 | 714KAI6..... | 332 |
| 628-O..... | 316 | 658L..... | 181 | 691MIL..... | 255 | 714KAI8..... | 332 |
| 628C..... | 316 | 658SP6..... | 124 | 691PV16..... | 124 | 714KAIL..... | 332 |
| 628MH..... | 316 | 658SP8..... | 124 | 693P..... | 320 | 714LDF..... | 253 |
| 628MP..... | 316 | 658VGE6..... | 270 | 6BB..... | 6 | 714ME6..... | 332 |
| 628P..... | 316 | 658VGE8..... | 270 | 6BB-O..... | 6 | 714ME8..... | 332 |
| 629P..... | 315 | 658VGL..... | 270 | 700SP..... | 121 | 714MEL..... | 332 |
| 630-O..... | 315 | 658W6..... | 181 | 701BSP..... | 121 | 714MH..... | 331 |
| 630ALD..... | 315 | 658W8..... | 181 | 701SP..... | 121 | 714MHI8..... | 332 |
| 630C..... | 315 | 658WC6..... | 332 | 702BSP..... | 121 | 714MI6..... | 255 |
| 630MH..... | 315 | 658WC8..... | 332 | 702SP..... | 121 | 714MI8..... | 255 |
| 630MP..... | 315 | 658WL..... | 181 | 703BSP..... | 121 | 714MIL..... | 255 |
| 630P..... | 315 | 658WSP6..... | 124 | 703SP..... | 121 | 714MP..... | 331 |
| 631-O..... | 315 | 658WSP8..... | 124 | 704SP..... | 121 | 714MUL..... | 253 |
| 631ALD..... | 315 | 658WVGE6..... | 270 | 705SP..... | 121 | 714OE6..... | 332 |
| 631C..... | 315 | 658WVGE8..... | 270 | 706SP..... | 121 | 714OE8..... | 332 |
| 631MH..... | 315 | 658WVGL..... | 270 | 707SP..... | 121 | 714OEL..... | 332 |
| 631MP..... | 315 | 659-O..... | 319 | 708SP..... | 121 | 714OI6..... | 332 |
| 631P..... | 315 | 659P..... | 319 | 709SP..... | 121 | 714OI8..... | 332 |
| 632-O..... | 316 | 660-O..... | 322 | 70S..... | 328 | 714OIL..... | 332 |
| 632ALD..... | 316 | 660ALD..... | 322 | 710SP..... | 121 | 714P..... | 331 |
| 632C..... | 316 | 660C..... | 322 | 711R..... | 271 | 714PE6..... | 332 |
| 632MH..... | 316 | 660MH..... | 322 | 711SP..... | 121 | 714PE8..... | 332 |
| 632MP..... | 316 | 660MP..... | 322 | 712I6..... | 182 | 714PEL..... | 332 |



Part Number Index

| | | | | | | | |
|---------------|-----|-------------|-----|-------------|----------|--------------|-----|
| 714PI6..... | 332 | 720-O..... | 323 | 752C..... | 331 | 833R..... | 272 |
| 714PI8..... | 332 | 720SP..... | 120 | 752KP..... | 121 | 833RFJ..... | 272 |
| 714PIL..... | 332 | 721-O..... | 323 | 752LDF..... | 253 | 833VG..... | 269 |
| 714PV16..... | 124 | 721ALD..... | 323 | 752MH..... | 331 | 841R..... | 273 |
| 714SAE6..... | 332 | 721C..... | 323 | 752MP..... | 331 | 850-0..... | 327 |
| 714SAE8..... | 332 | 721MH..... | 323 | 752MUL..... | 253 | 850-O3..... | 327 |
| 714SD6..... | 182 | 721MP..... | 323 | 752P..... | 331 | 851-0..... | 327 |
| 714SD8..... | 182 | 721P..... | 323 | 752SP..... | 121 | 851-03..... | 327 |
| 714SDL..... | 182 | 721SP..... | 120 | 752VG..... | 266 | 854-0..... | 327 |
| 714SP..... | 121 | 722R..... | 271 | 753-O..... | 331 | 854-03..... | 327 |
| 714SPE6..... | 124 | 722SP..... | 120 | 753C..... | 331 | 858-0..... | 327 |
| 714SPE8..... | 124 | 723-O..... | 323 | 753FJ..... | 178 | 859-0..... | 327 |
| 714SPI6..... | 124 | 723C..... | 323 | 753KA..... | 331 | 860-0..... | 327 |
| 714SPI8..... | 124 | 723MH..... | 323 | 753KP..... | 121 | 890VG..... | 266 |
| 714VG..... | 266 | 723MP..... | 323 | 753LDF..... | 253 | 892-O..... | 331 |
| 714VGE6..... | 270 | 723P..... | 323 | 753MH..... | 331 | 892C..... | 331 |
| 714VGE8..... | 270 | 723SP..... | 120 | 753MP..... | 331 | 892MP..... | 331 |
| 714VGL..... | 270 | 725VG..... | 266 | 753MUL..... | 253 | 893-O..... | 331 |
| 714W8..... | 181 | 729BP..... | 318 | 753P..... | 331 | 893C..... | 331 |
| 714WC6..... | 332 | 729LDF..... | 250 | 753SP..... | 121 | 893MP..... | 331 |
| 714WC8..... | 332 | 730-O..... | 316 | 753VG..... | 266 | 894-O..... | 331 |
| 714WCL..... | 332 | 732-O..... | 316 | 754KA..... | 331 | 894C..... | 331 |
| 714WFGE6..... | 270 | 733MUL..... | 250 | 755VG..... | 266 | 894MP..... | 331 |
| 714WFGE8..... | 270 | 734MUL..... | 250 | 756KA..... | 331 | 899-O..... | 331 |
| 714WFG..... | 270 | 735MUL..... | 202 | 756VG..... | 266 | 899C..... | 331 |
| 714WKA6..... | 332 | 736ALD..... | 321 | 757VG..... | 266 | 899MP..... | 331 |
| 714WKA8..... | 332 | 736MUL..... | 202 | 758KP..... | 121 | 8BB..... | 6 |
| 714WL..... | 181 | 737MUL..... | 250 | 758VG..... | 266 | 8BB-O..... | 6 |
| 714WM6..... | 332 | 738MUL..... | 250 | 759VG..... | 266 | 8FOS..... | 328 |
| 714WM8..... | 332 | 739MUL..... | 250 | 7ALDS..... | 328 | 8OS..... | 328 |
| 714WML..... | 332 | 739R..... | 273 | 7BB..... | 6 | 8RS..... | 274 |
| 714WO6..... | 332 | 740LDF..... | 250 | 7BB-O..... | 6 | 8RSD..... | 274 |
| 714WO8..... | 332 | 742R..... | 271 | 7CS..... | 328 | 8RVS..... | 274 |
| 714WOL..... | 332 | 750-O..... | 331 | 7MHS..... | 328 | 900SP..... | 123 |
| 714WP6..... | 332 | 750ALD..... | 331 | 7WLS..... | 328 | 901SP..... | 123 |
| 714WP8..... | 332 | 750C..... | 331 | 800SP..... | 121 | 903SP..... | 123 |
| 714WPL..... | 332 | 750FJ..... | 178 | 801BG..... | 95 | 904SP..... | 123 |
| 714WSA6..... | 332 | 750KA..... | 331 | 801SP..... | 121 | 905SP..... | 123 |
| 714WSA8..... | 332 | 750KP..... | 121 | 802BG..... | 95 | 906SP..... | 123 |
| 714WSP6..... | 124 | 750LDF..... | 253 | 802FJ..... | 346 | 907SP..... | 123 |
| 714WSP8..... | 124 | 750MH..... | 331 | 802SP..... | 346 | 908SP..... | 123 |
| 714WVGE6..... | 270 | 750MP..... | 331 | 802SP..... | 121 | 909-O..... | 329 |
| 714WVGE8..... | 270 | 750MUL..... | 253 | 803-O..... | 314 | 909ALD..... | 329 |
| 714WVGL..... | 270 | 750P..... | 331 | 803SP..... | 121, 346 | 909P..... | 329 |
| 715-O..... | 331 | 750SP..... | 121 | 807SP..... | 121 | 909SP..... | 123 |
| 715ALD..... | 331 | 750VG..... | 266 | 819R..... | 271 | 90CSP..... | 8 |
| 715C..... | 331 | 751-O..... | 331 | 820R..... | 271 | 90DP..... | 8 |
| 715FJ..... | 178 | 751ALD..... | 331 | 821R..... | 271 | 910-O..... | 329 |
| 715KA..... | 331 | 751C..... | 331 | 822R..... | 271 | 910P..... | 329 |
| 715KP..... | 121 | 751FJ..... | 178 | 823R..... | 271 | 911SP..... | 123 |
| 715LDF..... | 253 | 751KA..... | 331 | 825R..... | 272 | 912-O..... | 330 |
| 715MH..... | 331 | 751KP..... | 121 | 826AR..... | 272 | 912SP..... | 123 |
| 715MP..... | 331 | 751LDF..... | 253 | 826R..... | 272 | 913-O..... | 330 |
| 715MUL..... | 253 | 751MH..... | 331 | 827R..... | 273 | 914KAI6..... | 332 |
| 715P..... | 331 | 751MP..... | 331 | 827WR..... | 273 | 914KAI8..... | 332 |
| 715SP..... | 121 | 751MUL..... | 253 | 828TP..... | 274 | 914KAIL..... | 332 |
| 715VG..... | 266 | 751P..... | 331 | 830R..... | 271 | 914WKA6..... | 332 |
| 716SP..... | 121 | 751SP..... | 121 | 833-O..... | 323 | 914WKA8..... | 332 |
| 717SP..... | 121 | 751VG..... | 266 | 833ALD..... | 323 | 916SP..... | 123 |
| 717VG..... | 266 | 752-O..... | 331 | 833C..... | 323 | 91CSP..... | 8 |
| 719SP..... | 121 | 752ALD..... | 331 | 833MH..... | 323 | 91DP..... | 8 |



Part Number Index

| | | | | | | | |
|--------------|-----|--------------|-----|--------------|-----|---------------|----------|
| 925-O..... | 324 | 995P..... | 330 | CM73-O..... | 305 | CR63A..... | 333 |
| 925-OPL..... | 324 | 996LDF..... | 253 | CM73ALD..... | 305 | CR64..... | 333 |
| 928-O..... | 325 | 998MUL..... | 200 | CM73C..... | 305 | CR65..... | 333 |
| 928-OPL..... | 325 | 998P..... | 330 | CM73MH..... | 305 | CR66..... | 333 |
| 92DP..... | 8 | 999LDF..... | 252 | CM73MP..... | 305 | CR67..... | 333 |
| 931P..... | 325 | 9BB..... | 6 | CM73P..... | 305 | CR68..... | 333 |
| 931PPL..... | 325 | 9BB-O..... | 6 | CM74-O..... | 301 | CR69..... | 333 |
| 932P..... | 324 | BA42..... | 333 | CM74ALD..... | 301 | CR70..... | 333 |
| 932PPL..... | 324 | BA43C..... | 333 | CM74C..... | 301 | CR72..... | 333 |
| 933P..... | 326 | BA44..... | 333 | CM74MH..... | 301 | CR800P..... | 310 |
| 933PPL..... | 326 | BA46..... | 333 | CM74MP..... | 301 | CR806P..... | 304 |
| 93DP..... | 8 | BA47..... | 333 | CM74P..... | 301 | CR810P..... | 303 |
| 94DP..... | 8 | BA48..... | 333 | CM74SF..... | 90 | CR820P..... | 301 |
| 950-O..... | 324 | BA8440..... | 338 | CM75..... | 334 | CR830P..... | 305 |
| 950P..... | 324 | BA8442..... | 338 | CM76..... | 334 | CR841P..... | 307 |
| 951-O..... | 324 | BA8444..... | 338 | CM77..... | 334 | CR862-O..... | 310 |
| 951P..... | 324 | BB15..... | 333 | CM80..... | 334 | CR862P..... | 310 |
| 951R..... | 275 | BB17..... | 333 | CM81..... | 334 | CR864P..... | 303 |
| 953FJ..... | 177 | BB8108..... | 338 | CM82..... | 334 | CR880P..... | 306 |
| 953RFJ..... | 272 | BB8109..... | 338 | CM83..... | 334 | CRO..... | 347 |
| 953VG..... | 269 | BB8110..... | 338 | CM84..... | 334 | CRO-NO..... | 347 |
| 954FJ..... | 177 | BB8111..... | 338 | CM85..... | 334 | CRR..... | 347 |
| 955R..... | 275 | BB8122..... | 338 | CM86..... | 334 | DE168P..... | 313 |
| 956-O..... | 326 | CA30..... | 333 | CM87..... | 334 | DE169P..... | 313 |
| 95DP..... | 8 | CA31..... | 333 | CM8780..... | 339 | DE170P..... | 313 |
| 95MSP..... | 8 | CA326-O..... | 282 | CM8782..... | 339 | DE171-O..... | 313 |
| 96DP..... | 8 | CA326P..... | 282 | CM8783..... | 339 | DE171P..... | 313 |
| 96MSP..... | 8 | CA327P..... | 285 | CM88..... | 334 | DE73P..... | 235, 313 |
| 970ALD..... | 277 | CA36..... | 333 | CM8801..... | 339 | DE74P..... | 235, 313 |
| 970LDF..... | 185 | CA364P..... | 284 | CM8808..... | 339 | DH190-O..... | 287 |
| 976LDF..... | 252 | CA37..... | 333 | CM8810..... | 339 | DH190P..... | 287 |
| 977LDF..... | 252 | CA38..... | 333 | CM8812..... | 339 | DH99..... | 333 |
| 978P..... | 330 | CA39..... | 333 | CM8820..... | 339 | EB1..... | 347 |
| 978VG..... | 266 | CA40..... | 333 | CM8823..... | 339 | EB2..... | 347 |
| 979FJ..... | 175 | CA41..... | 333 | CM8825..... | 339 | F800..... | 269 |
| 979SP..... | 122 | CA8320..... | 338 | CM8830..... | 339 | F801..... | 269 |
| 980FJ..... | 175 | CA8322..... | 338 | CM8834..... | 339 | F802..... | 269, 346 |
| 980SP..... | 122 | CA8326..... | 338 | CM8837..... | 339 | F802FJ..... | 269, 346 |
| 981SP..... | 122 | CA8330..... | 338 | CM8840..... | 339 | F803..... | 269, 346 |
| 982SP..... | 122 | CA8336..... | 338 | CM8853..... | 339 | F804..... | 269 |
| 984SP..... | 122 | CA8338..... | 338 | CM8854..... | 339 | F804FJ..... | 269 |
| 985FJ..... | 175 | CA8340..... | 338 | CM8856..... | 339 | F805..... | 269 |
| 985SP..... | 122 | CA8342..... | 338 | CM8857..... | 339 | F806..... | 269 |
| 986LDF..... | 252 | CA8344..... | 338 | CM8858..... | 339 | F925..... | 268 |
| 987LDF..... | 252 | CA8347..... | 338 | CM8859..... | 339 | F925PL..... | 268 |
| 990FJ..... | 175 | CA8348..... | 338 | CM8860..... | 339 | F926..... | 267 |
| 990LDF..... | 252 | CH..... | 346 | CM8862..... | 339 | F926PL..... | 267 |
| 990SP..... | 122 | CM15BM..... | 90 | CM89..... | 334 | F927..... | 268 |
| 991LDF..... | 252 | CM16FL..... | 90 | CM90..... | 334 | F927PL..... | 268 |
| 992-O..... | 330 | CM16FL2..... | 91 | CM93..... | 334 | F928..... | 268 |
| 992FJ..... | 175 | CM16JE2..... | 91 | CM94..... | 334 | F928PL..... | 268 |
| 992LDF..... | 252 | CM24RN..... | 91 | CM95..... | 334 | F932..... | 267 |
| 992P..... | 330 | CM30AL..... | 91 | CM96..... | 334 | F932PL..... | 267 |
| 992SP..... | 122 | CM32RO2..... | 91 | CO705P..... | 304 | F951FJ..... | 267 |
| 993FJ..... | 175 | CM32SG..... | 91 | COR5X10..... | 88 | F955..... | 267 |
| 993LDF..... | 252 | CM36NI..... | 90 | CPO..... | 346 | F956..... | 267 |
| 994-O..... | 330 | CM38SY..... | 90 | CPR..... | 346 | F956FJ..... | 267 |
| 994FJ..... | 175 | CM67WT..... | 90 | CPS-0..... | 347 | FL1X4VG..... | 266 |
| 994LDF..... | 252 | CM70..... | 334 | CR13..... | 343 | FLV16X24..... | 88 |
| 994P..... | 330 | CM71..... | 334 | CR14..... | 343 | FR15..... | 343 |
| 995LDF..... | 252 | CM72..... | 334 | CR61..... | 333 | FR458W..... | 181 |



Part Number Index

| | | | | | | | |
|----------------|-----|----------------|-----|----------------|-----|---------------|----------|
| FR458W8..... | 181 | HR619-O..... | 331 | OBC-O..... | 7 | PF714W6..... | 351 |
| FR626-O..... | 331 | HR619ALD..... | 331 | P802FJ..... | 346 | PF714W8..... | 351 |
| FR626C..... | 331 | HR619C..... | 331 | PAK1x4BW..... | 100 | PFFAST8..... | 352 |
| FR626P..... | 331 | HR619MP..... | 331 | PAK1x6BW..... | 100 | PFBKM6..... | 352 |
| FR627-O..... | 331 | HR619P..... | 331 | PAK1x6LAP..... | 100 | PFBKM8..... | 352 |
| FR627C..... | 331 | HR620-O..... | 331 | PB1..... | 5 | PFBKMK..... | 352 |
| FR627P..... | 331 | HR620ALD..... | 331 | PB1-O..... | 5 | PFSM..... | 352 |
| FR714W..... | 181 | HR620C..... | 331 | PB10..... | 5 | PIL6X108..... | 88 |
| FR8920..... | 340 | HR620MP..... | 331 | PB10-O..... | 5 | PIL8108..... | 88 |
| FR8921..... | 340 | HR620P..... | 331 | PB11..... | 5 | PM07..... | 335 |
| FR8922..... | 340 | HR621-O..... | 331 | PB11-O..... | 5 | PM08..... | 335 |
| FR8923..... | 340 | HR621ALD..... | 331 | PB2..... | 5 | PM09..... | 335 |
| FR8940..... | 340 | HR621C..... | 331 | PB2-O..... | 5 | PM10..... | 335 |
| FR8950..... | 340 | HR621MP..... | 331 | PB20..... | 5 | PM11..... | 335 |
| FR8953..... | 340 | HR621P..... | 331 | PB20-O..... | 5 | PM12..... | 335 |
| FR8954..... | 340 | HR622-O..... | 331 | PB20ALD..... | 5 | PM14..... | 335 |
| FR8955..... | 340 | HR622ALD..... | 331 | PB20C..... | 5 | PM16..... | 335, 343 |
| FR8956..... | 340 | HR622C..... | 331 | PB20MDF..... | 5 | PM20..... | 335 |
| FR8957..... | 340 | HR622MP..... | 331 | PB20MP..... | 5 | PM22..... | 335 |
| FR8958..... | 340 | HR622P..... | 331 | PB21..... | 5 | PM22PL..... | 335 |
| FR8960..... | 340 | HR623-O..... | 331 | PB21-O..... | 5 | PM23B..... | 335 |
| FR8965..... | 340 | HR623ALD..... | 331 | PB21ALD..... | 5 | PM24..... | 335 |
| FR8967..... | 340 | HR623C..... | 331 | PB21C..... | 5 | PM25..... | 335 |
| FR8968..... | 343 | HR623MP..... | 331 | PB21MDF..... | 5 | PM27..... | 335 |
| FR8970..... | 343 | HR623P..... | 331 | PB21MP..... | 5 | PM50..... | 335 |
| FR8971..... | 343 | HR624-O..... | 331 | PB22..... | 5 | PM52..... | 335 |
| FR8980..... | 343 | HR624ALD..... | 331 | PB22-O..... | 5 | PM54..... | 335 |
| FR8982..... | 343 | HR624C..... | 331 | PB22ALD..... | 5 | PM55..... | 335 |
| FRLV16..... | 88 | HR624MP..... | 331 | PB22C..... | 5 | PM56B..... | 335 |
| FRLV18..... | 88 | HR624P..... | 331 | PB22MDF..... | 5 | PM57..... | 335 |
| FRLV22..... | 88 | IBC..... | 7 | PB22MP..... | 5 | PM58..... | 335 |
| FRLV24..... | 88 | IBC-O..... | 7 | PB23..... | 5 | PM59..... | 335 |
| FRLV24TK..... | 88 | JAMBEXT..... | 124 | PB23-O..... | 5 | PM595..... | 335 |
| FRPR418W6..... | 181 | LM90..... | 336 | PB23ALD..... | 5 | PM70..... | 335 |
| FRPR418W8..... | 181 | LM91..... | 336 | PB23C..... | 5 | PM71..... | 335 |
| FRPR458W6..... | 181 | LM92..... | 336 | PB23MDF..... | 5 | PM72..... | 335 |
| FRPR458W8..... | 181 | MD1..... | 345 | PB23MP..... | 5 | PM73..... | 335 |
| FRPR514W..... | 181 | MD2..... | 345 | PB24..... | 5 | PM74..... | 335 |
| FRPR514W8..... | 181 | MD3..... | 345 | PB24-O..... | 5 | PM8511..... | 341 |
| FRPR714W..... | 181 | MD4..... | 345 | PB24ALD..... | 5 | PM8520..... | 341 |
| FRPR714W8..... | 181 | MD5..... | 345 | PB24C..... | 5 | PM8522..... | 341 |
| FS4916W6..... | 181 | MD6..... | 345 | PB24MDF..... | 5 | PM8523..... | 341 |
| FS4916W8..... | 181 | MLD405-12..... | 89 | PB24MP..... | 5 | PM8524..... | 341 |
| FS514W6..... | 181 | MLD410-12..... | 89 | PB3..... | 5 | PM8525..... | 341 |
| FS514W8..... | 181 | MLD425-12..... | 89 | PB3-O..... | 5 | PM8526..... | 341 |
| FS6916W6..... | 181 | MLD432-12..... | 89 | PB4..... | 5 | PM8527..... | 341 |
| FS6916W8..... | 181 | MLD460-12..... | 89 | PB4-O..... | 5 | PM8528..... | 341 |
| FS714W6..... | 181 | MLD490-12..... | 89 | PB6..... | 5 | PM8529..... | 341 |
| FS714W8..... | 181 | MLD493-12..... | 89 | PB6-O..... | 5 | PM8532..... | 341 |
| HC150-O..... | 287 | MLD495-16..... | 89 | PB7..... | 5 | PM8535..... | 341 |
| HC150ALD..... | 287 | MLD560-8..... | 89 | PB7-O..... | 5 | PM8538..... | 341 |
| HC150P..... | 287 | MLD564-16..... | 89 | PB8..... | 5 | PM8540..... | 341 |
| HC150VG..... | 257 | MLD732-12..... | 89 | PB8-O..... | 5 | PM8545..... | 341 |
| HR617-O..... | 331 | MLH..... | 346 | PB9..... | 5 | PM8546..... | 341 |
| HR617C..... | 331 | MS1..... | 345 | PB9-O..... | 5 | PM8552..... | 342 |
| HR617P..... | 331 | MS2..... | 345 | PC..... | 346 | PM8553..... | 342 |
| HR618-O..... | 331 | MS3..... | 345 | PF4916W6..... | 351 | PM8555..... | 342 |
| HR618ALD..... | 331 | MS4..... | 345 | PF4916W8..... | 351 | PM8557..... | 342 |
| HR618C..... | 331 | MS5..... | 345 | PF514W6..... | 351 | PM8558..... | 342 |
| HR618MP..... | 331 | MS6..... | 345 | PF514W8..... | 351 | PM8560..... | 342 |
| HR618P..... | 331 | OBC..... | 7 | PF6916W6..... | 351 | PM8561..... | 342 |



Part Number Index

| | | | | | | | |
|-----------------|-----------|-----------------|-----|----------------|-----|----------------|-----|
| PM8564..... | 342 | PR177BFJ..... | 132 | PR4186..... | 181 | PR658DRL..... | 180 |
| PM8565..... | 342 | PR177FJ..... | 132 | PR4188..... | 181 | PR658L..... | 181 |
| PM8568..... | 342 | PR186FJ..... | 133 | PR418L..... | 181 | PR658W6..... | 181 |
| PM8569..... | 342 | PR192FJ..... | 125 | PR418W6..... | 181 | PR658W6D..... | 181 |
| PM8571..... | 342 | PR193FJ..... | 125 | PR418W6D..... | 181 | PR658W8..... | 181 |
| PM8572..... | 342 | PR198FJ..... | 135 | PR418W8..... | 181 | PR658W8D..... | 181 |
| PM8573..... | 342 | PR199FJ..... | 135 | PR418W8D..... | 181 | PR658WL..... | 181 |
| PR..... | 347 | PR200FJ..... | 179 | PR418WL..... | 181 | PR6916I6..... | 182 |
| PR102FJ..... | 125 | PR2001FJ..... | 179 | PR430FJ-4..... | 158 | PR6916I6D..... | 182 |
| PR103BFJ..... | 126 | PR300AFJ..... | 138 | PR434E6..... | 181 | PR6916I8..... | 182 |
| PR107FJ..... | 125 | PR300ALVL..... | 138 | PR434E8..... | 181 | PR6916I8D..... | 182 |
| PR108FJ..... | 127 | PR300BFJ..... | 138 | PR434EL..... | 181 | PR6916IL..... | 182 |
| PR110BFJ-2..... | 126 | PR300BLVL..... | 138 | PR434I6..... | 182 | PR713FJ..... | 178 |
| PR110FJ-3..... | 130 | PR304FJ..... | 138 | PR434I6D..... | 182 | PR714DR6..... | 180 |
| PR118FJ-3..... | 141 | PR305FJ..... | 138 | PR434I8..... | 182 | PR714DR8..... | 180 |
| PR118FJ-4..... | 136, 1433 | PR306FJ..... | 138 | PR434I8D..... | 182 | PR714DRL..... | 180 |
| PR119FJ..... | 129 | PR307FJ..... | 141 | PR434IL..... | 182 | PR714E6..... | 181 |
| PR120BFJ..... | 128 | PR30BB..... | 7 | PR434W6..... | 181 | PR714E8..... | 181 |
| PR123FJ..... | 129 | PR310FJ..... | 138 | PR434W8..... | 181 | PR714EL..... | 181 |
| PR128FJ..... | 127 | PR311FJ..... | 141 | PR434WL..... | 181 | PR714I6..... | 182 |
| PR129FJ..... | 130 | PR314FJ-2..... | 138 | PR4586..... | 181 | PR714I6D..... | 182 |
| PR131FJ..... | 128 | PR314FJ-4..... | 143 | PR4588..... | 181 | PR714I8..... | 182 |
| PR132FJ..... | 127 | PR316FJ..... | 143 | PR458DR6..... | 180 | PR714I8D..... | 182 |
| PR133BFJ..... | 130 | PR318BFJ-4..... | 143 | PR458DRL..... | 180 | PR714IL..... | 182 |
| PR133FJ..... | 130 | PR318FJ-5..... | 147 | PR458L..... | 181 | PR714W6..... | 181 |
| PR135FJ..... | 131 | PR321FJ-5..... | 148 | PR458W6..... | 181 | PR714W8..... | 181 |
| PR136FJ..... | 136 | PR323FJ..... | 146 | PR458W6D..... | 181 | PR714WL..... | 181 |
| PR137FJ..... | 127 | PR325FJ..... | 144 | PR458W8..... | 181 | PR715FJ..... | 178 |
| PR139BFJ..... | 134 | PR328FJ-5..... | 148 | PR458W8D..... | 181 | PR739R..... | 273 |
| PR139FJ..... | 131 | PR338FJ-3..... | 140 | PR458WL..... | 181 | PR750FJ..... | 178 |
| PR141FJ..... | 126 | PR338FJ-4..... | 145 | PR4916I6..... | 182 | PR751FJ..... | 178 |
| PR142FJ..... | 125 | PR344FJ-3..... | 140 | PR4916I6D..... | 182 | PR753FJ..... | 178 |
| PR143FJ..... | 126 | PR347FJ-3..... | 140 | PR4916I8..... | 182 | PR760FJ..... | 178 |
| PR146FJ-2..... | 129 | PR349FJ-4..... | 144 | PR4916I8D..... | 182 | PR760RFJ..... | 272 |
| PR146FJ-3..... | 133 | PR349FJ-5..... | 148 | PR4916IL..... | 182 | PR761FJ..... | 178 |
| PR146FJ-4..... | 136 | PR352FJ..... | 149 | PR514DR6..... | 180 | PR762FJ..... | 178 |
| PR148FJ..... | 130 | PR356FJ-3..... | 140 | PR514DRL..... | 180 | PR763FJ..... | 178 |
| PR149FJ-2..... | 126 | PR358FJ..... | 141 | PR514E6..... | 181 | PR764FJ..... | 178 |
| PR149FJ-3..... | 133 | PR362FJ-4..... | 136 | PR514E8..... | 181 | PR765FJ..... | 178 |
| PR150FJ..... | 128 | PR362FJ-4..... | 143 | PR514EL..... | 181 | PR766FJ..... | 178 |
| PR152FJ..... | 127 | PR365FJ-3..... | 141 | PR514I6..... | 182 | PR767FJ..... | 178 |
| PR152FJ-1..... | 125 | PR371FJ-3..... | 140 | PR514I6D..... | 182 | PR768FJ..... | 178 |
| PR156FJ..... | 133 | PR371FJ-4..... | 144 | PR514I8..... | 182 | PR769FJ..... | 178 |
| PR157FJ..... | 128 | PR372FJ-4..... | 145 | PR514I8D..... | 182 | PR770FJ..... | 178 |
| PR158FJ-2..... | 127 | PR372FJ-5..... | 150 | PR514IL..... | 182 | PR771FJ..... | 178 |
| PR158FJ-3..... | 131 | PR372FJ-7..... | 153 | PR514W6..... | 181 | PR772FJ..... | 178 |
| PR158FJ-4..... | 136 | PR380FJ..... | 145 | PR514W6D..... | 181 | PR773FJ..... | 178 |
| PR159FJ..... | 128 | PR387FJ-3..... | 142 | PR514W8..... | 181 | PR774FJ..... | 178 |
| PR162FJ..... | 127 | PR3916I6..... | 182 | PR514W8D..... | 181 | PR775FJ..... | 178 |
| PR163FJ..... | 128 | PR3916I6D..... | 182 | PR514WL..... | 181 | PR827R..... | 273 |
| PR165FJ..... | 129 | PR3916I6K2..... | 182 | PR6186..... | 181 | PR829R..... | 273 |
| PR166FJ..... | 133 | PR3916I8..... | 182 | PR6188..... | 181 | PR833BFJ..... | 177 |
| PR167FJ..... | 127 | PR3916I8D..... | 182 | PR618L..... | 181 | PR833FJ..... | 177 |
| PR169FJ..... | 129 | PR3916I8K2..... | 182 | PR618W6..... | 181 | PR833RFJ..... | 272 |
| PR170FJ..... | 132 | PR3916IL..... | 182 | PR618W8..... | 181 | PR841R..... | 273 |
| PR172FJ-2..... | 129 | PR408FJ..... | 164 | PR618WL..... | 181 | PR842R..... | 272 |
| PR172FJ-3..... | 135 | PR410FJ-6..... | 164 | PR6586..... | 181 | PR844RFJ..... | 272 |
| PR175FJ-2..... | 129 | PR4126..... | 181 | PR6588..... | 181 | PR953FJ..... | 177 |
| PR175FJ-3..... | 134 | PR4128..... | 181 | PR658DR6..... | 180 | PR969FJ..... | 125 |
| PR176FJ..... | 132 | PR412L..... | 181 | PR658DR8..... | 180 | PR970FJ..... | 125 |



Part Number Index

| | | | |
|----------------|-----|----------------|-----|
| PR990FJ..... | 175 | ROS169-O..... | 5 |
| PR990LDF..... | 252 | ROS169ALD..... | 5 |
| PR990MUL..... | 252 | ROS169C..... | 5 |
| PR992FJ..... | 175 | ROS169MDF..... | 5 |
| PR992LDF..... | 252 | ROS169MP..... | 5 |
| PR992MUL..... | 252 | ROS170MDF..... | 5 |
| PR993LDF..... | 252 | ROS171MDF..... | 5 |
| PR993MUL..... | 252 | ROS172MDF..... | 5 |
| PR994FJ..... | 175 | SS..... | 347 |
| PR994LDF..... | 252 | UR612B..... | 352 |
| PR994MUL..... | 252 | UR953..... | 352 |
| PR995MUL..... | 252 | WG4916W8..... | 351 |
| PR996FJ..... | 175 | WGAST8..... | 352 |
| PR999MUL..... | 252 | WGBKM6..... | 352 |
| PS..... | 346 | WGBKM8..... | 352 |
| R2000-O..... | 321 | WR..... | 347 |
| R2000ALD..... | 321 | | |
| R2000P..... | 321 | | |
| R2000VG..... | 264 | | |
| R2003VG..... | 264 | | |
| R304-O3..... | 288 | | |
| R304MUL-2..... | 201 | | |
| R304SP-2..... | 107 | | |
| R304VG-2..... | 259 | | |
| R306SP-2..... | 108 | | |
| R306VG-3..... | 259 | | |
| RLV18..... | 88 | | |
| ROS158..... | 5 | | |
| ROS158-O..... | 5 | | |
| ROS160..... | 5 | | |
| ROS160-O..... | 5 | | |
| ROS160ALD..... | 5 | | |
| ROS160C..... | 5 | | |
| ROS160MDF..... | 5 | | |
| ROS160MP..... | 5 | | |
| ROS162..... | 5 | | |
| ROS162-O..... | 5 | | |
| ROS162ALD..... | 5 | | |
| ROS162C..... | 5 | | |
| ROS162MDF..... | 5 | | |
| ROS162MP..... | 5 | | |
| ROS164..... | 5 | | |
| ROS164-O..... | 5 | | |
| ROS164ALD..... | 5 | | |
| ROS164C..... | 5 | | |
| ROS164MDF..... | 5 | | |
| ROS164MP..... | 5 | | |
| ROS165..... | 5 | | |
| ROS165-O..... | 5 | | |
| ROS165ALD..... | 5 | | |
| ROS165C..... | 5 | | |
| ROS165MDF..... | 5 | | |
| ROS165MP..... | 5 | | |
| ROS166..... | 5 | | |
| ROS166-O..... | 5 | | |
| ROS167..... | 5 | | |
| ROS167-O..... | 5 | | |
| ROS168..... | 5 | | |
| ROS168-O..... | 5 | | |
| ROS169..... | 5 | | |



Thank you for choosing EL & EL WOOD PRODUCTS

Since 1967, we've helped architects, designers, contractors, builders and homeowners bring their dream spaces to life. EL & EL is committed to innovative thinking and processes that deliver a comprehensive product offering backed by the best people in the industry. Guaranteed.



EL & EL Wood Products
HALF A CENTURY OF SERVICE

WHOLESALE ONLY



ELandELWoodProducts.com

©2018 EL & EL Wood Products Corp. All rights reserved. EL & EL and the EL & EL Diamond Logo are trademarks of EL & EL Wood Products Corp. Registered trademarks are registered in the U.S. and may be registered internationally.